









Thank you for purchasing this product. Please take time to read and follow the instructions below. Check that you have all parts and hardware before assembly. Parts apparently missing are often found in the packing materials. If you do not have all the parts listed, have your dealer contact us and they be sent to you immediately.

It is recommended to install protective pads under all legs and support to avoid damage or scratches when placing furniture on a wood floor or other hard surface, and to limit Indentation and prevent discoloration if placing on carpet.

RC- PART LIST			
NO.	DESCRIPTION	DRAWING	QTY
A	CHAISE		1 PC
B	BACK REST		1 PC
C	BACK CUSHION (Packed in LL)		1 PC
D	WOODEN LEG 4.5"*3-1/7"*2"		4 PCS
E	WOODEN LEG 3-1/7"*3-1/7"*2"		1 PC
F	SCREW M5*2"		10 PCS

LL - PART LIST			
NO.	DESCRIPTION	DRAWING	QTY
G	SEATER		1 PC
H	BACK CUSHION		1 PC
I	BACK REST (Packed in RC)		1 PC

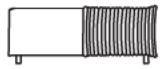
STEP 1:

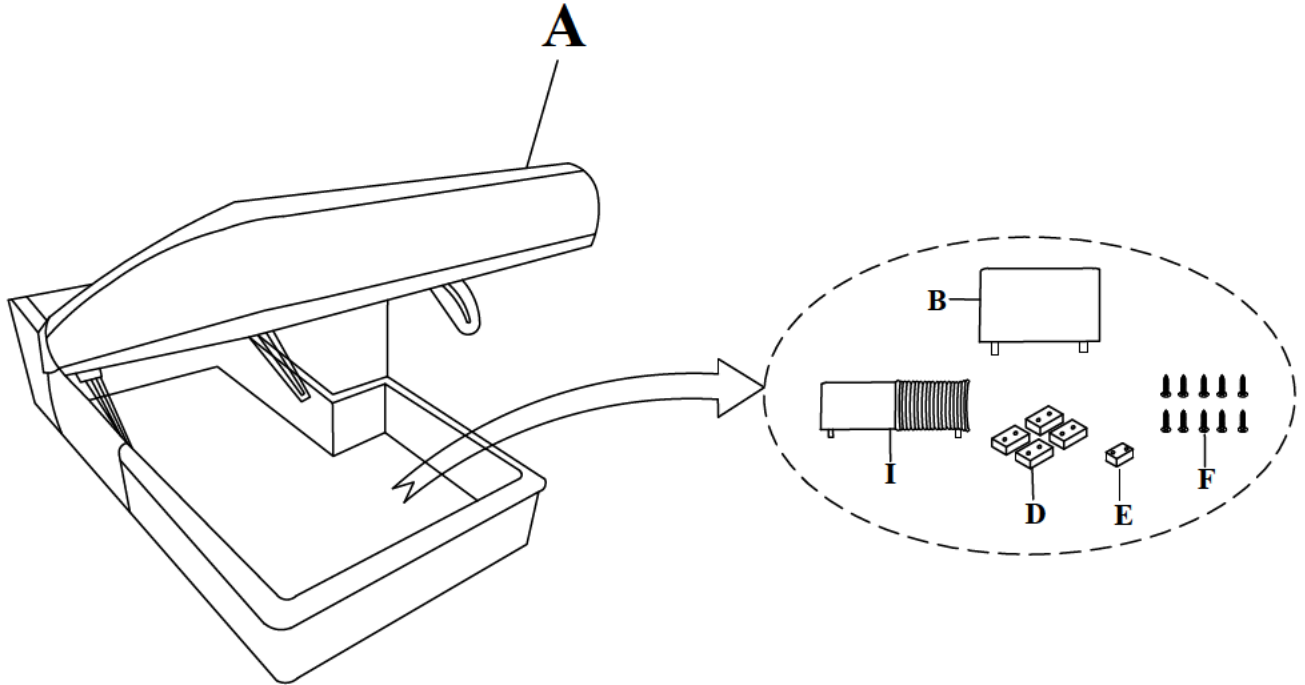

STEP 2:

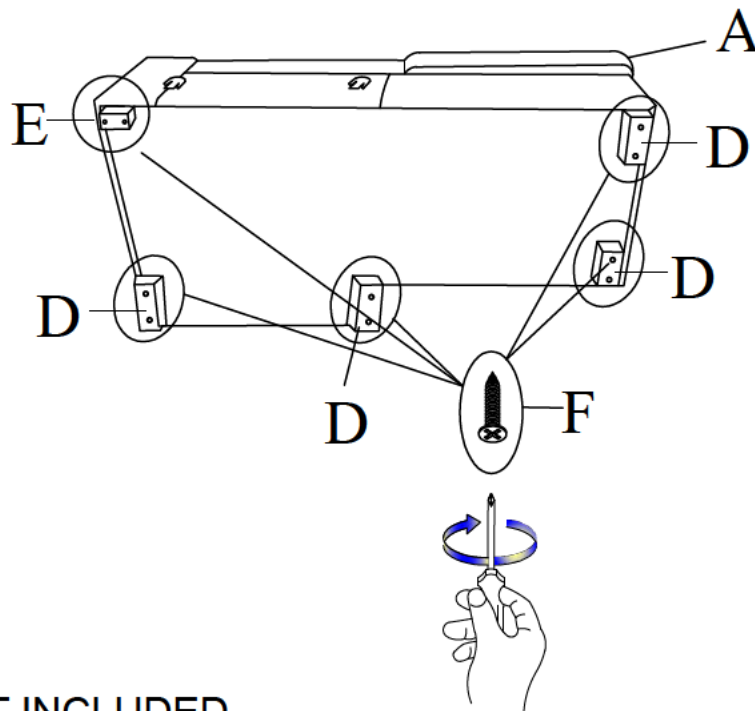

SCREWDRIVER NOT INCLUDED

STEP 3:

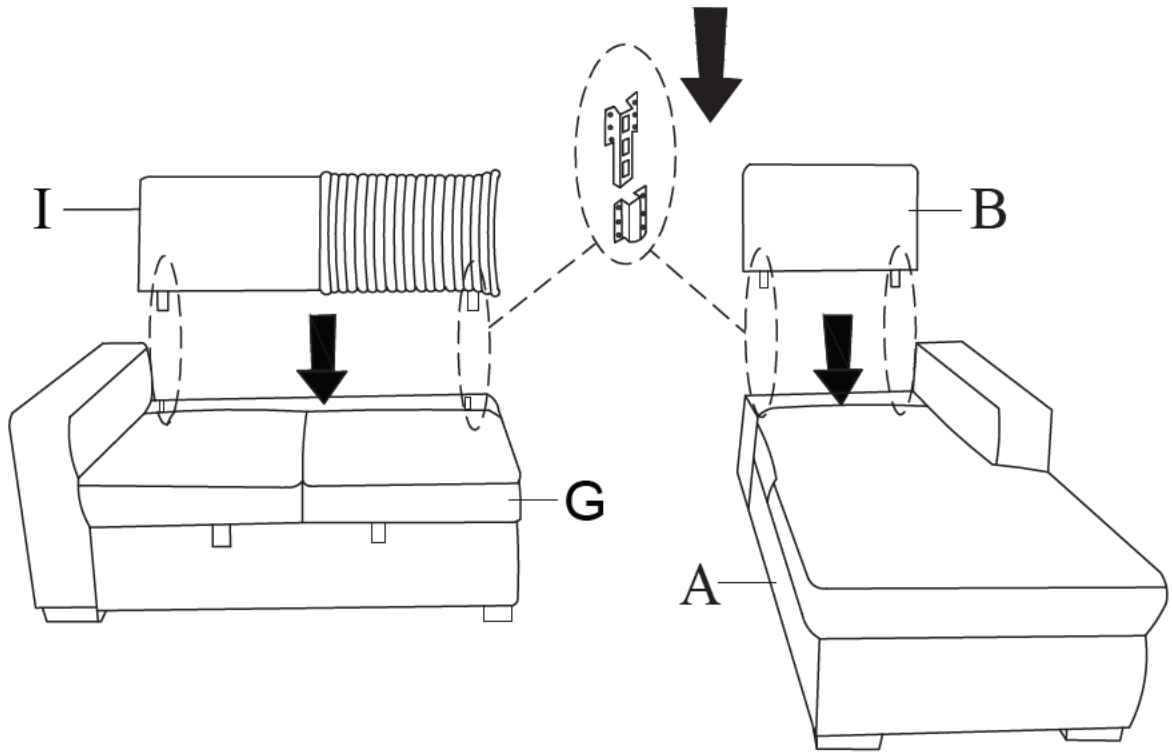

STEP 4:

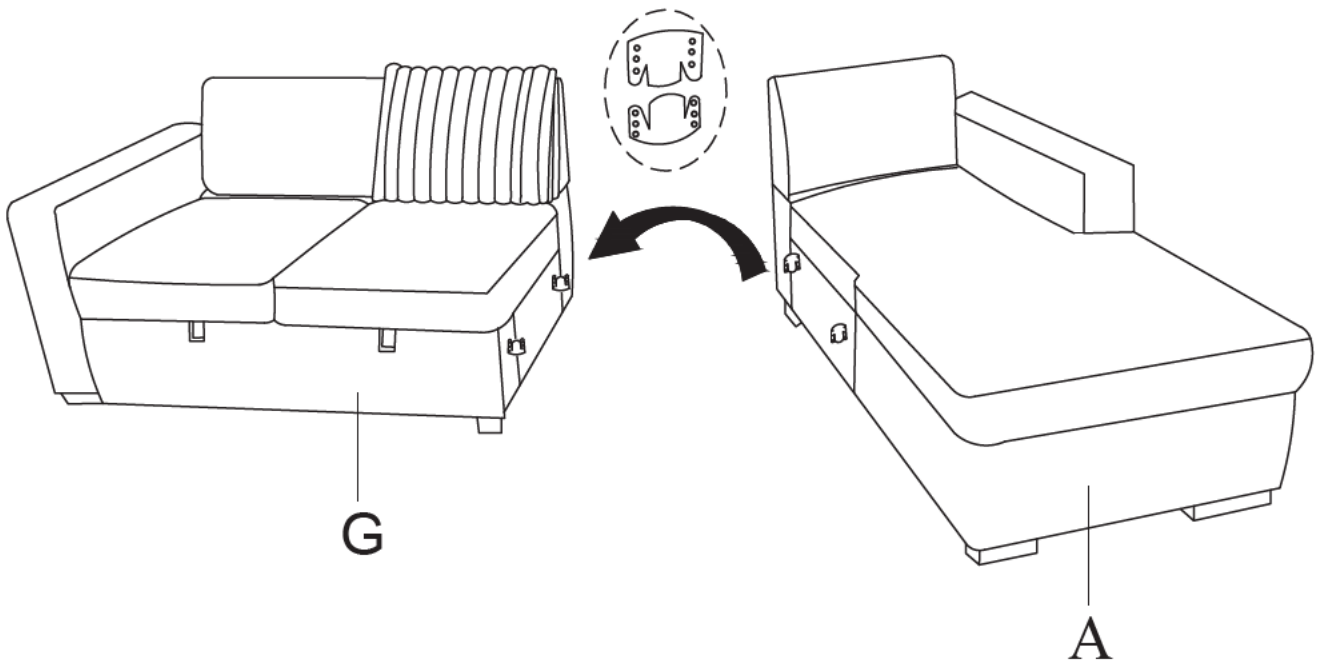

(1/2) Left Side 2-Seater Drop-Down Cup holders & Pull-out Bed

(2/2) Right Side Chaise With Hidden Storage

STEP 5:

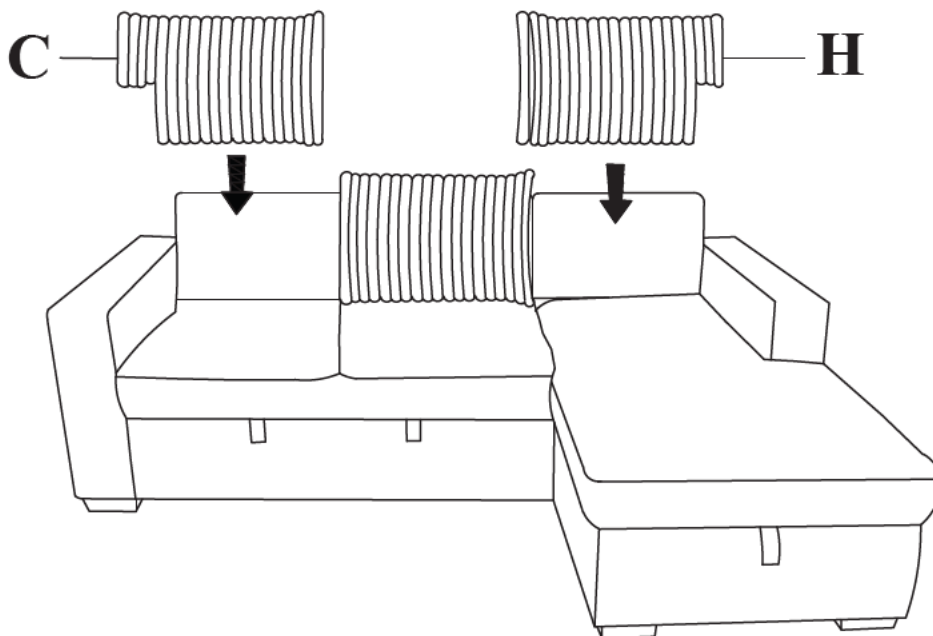

STEP 6:

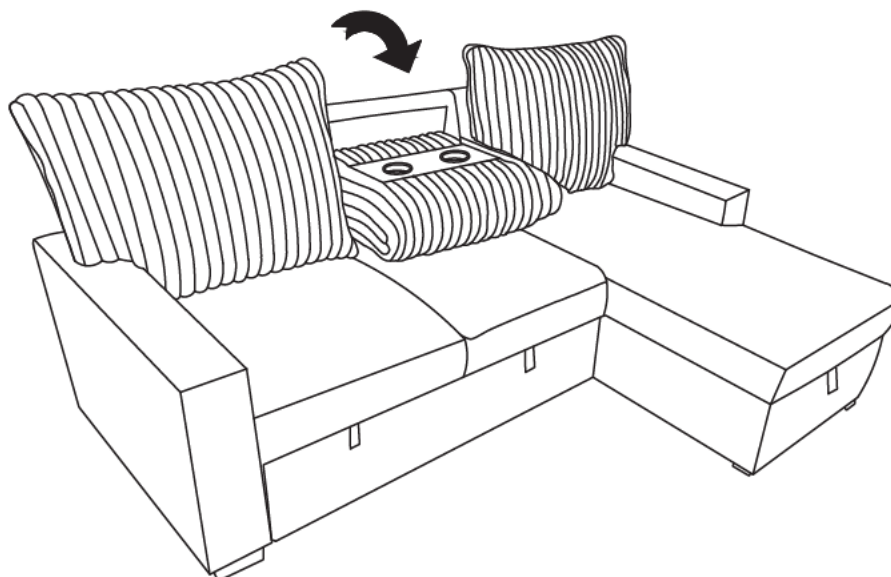

STEP 7:

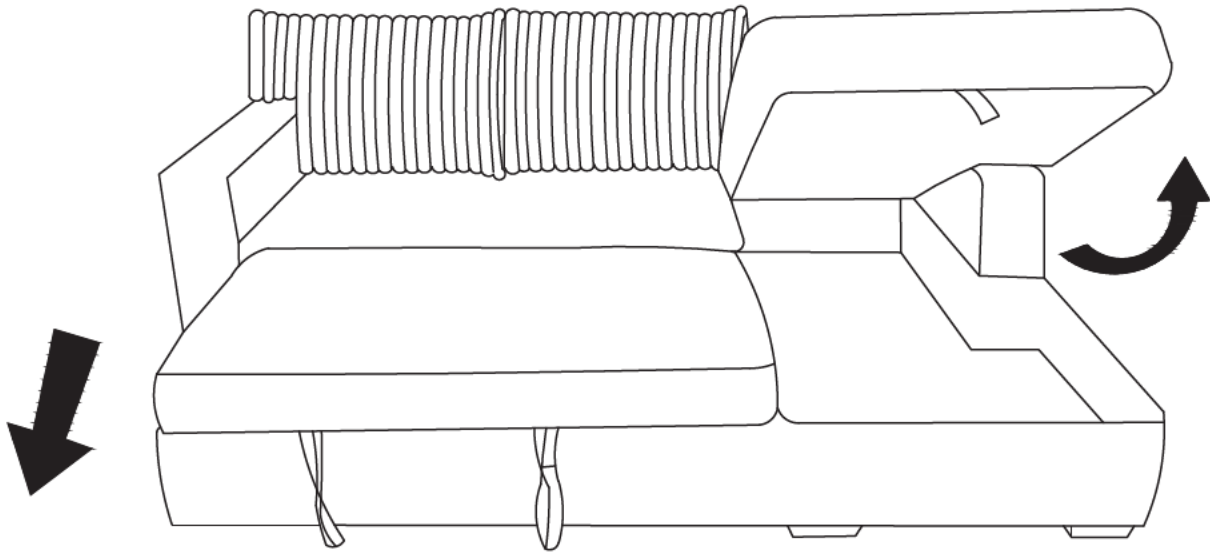

Care Instruction for Boucle Furniture:

In order to maintain the original appearance of your Boucle Furniture, please follow below simple care procedures:

- Avoid exposing furniture directly to sunlight or heating and airconditioning outlets. Sunlight and or exposure to heating and air conditioning outlets will fade/damage Boucle.
- Vacuum or wipe with a soft cloth to remove dust.
- Hardware may loosen over time. Periodically check to make sure all connection are tight, Re-tighten if necessary.



For items use on wooden floor, hard surfaces or carpets, it is recommended to Install protective pads under all legs and supports to avoid/prevent from damages/scratches and discoloration.