



626 679 3588
support@trendytotesinc.com
162 Atlantic St, Pomona, CA 91768

INSTALLATION MANUAL

ACRYLIC SHOWER BASE



PRODUCT
INSTRUCTION
VIDEO

support@trendytotesinc.com
626 679 3588

THANK YOU!

Dear Valued Customer,

Thanks to your kind support of NTQ, we hope our product can improve the quality of your life.

As our valued customer, your comments and opinions are very important to us. If you have any concerns, questions, or comments, we hope that you will bring them to our attention.

Please keep the carton and packaging materials until your product is completely installed.

Feel free to contact us if you encounter any problems such as missing parts, or product defects during the installation process. We are happy to provide you with the most sincere service.



*Sincerely,
Service Team*

AVAILABLE SIZES

W 30" x D 30"

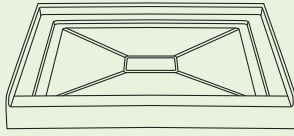

GSB-3030-C

W 32" x D 32"

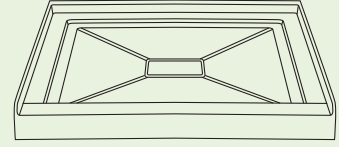

GSB-3232-C

W 34" x D 34"

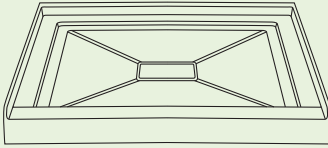

GSB-3434-C

W 36" x D 36"

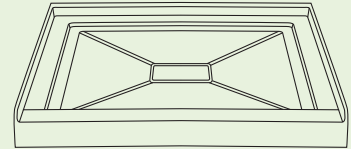

GSB-3636-C

W 48" x D 32"

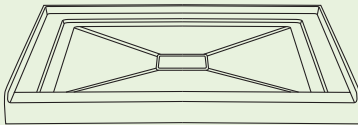

GSB-4832-C

W 60" x D 32"

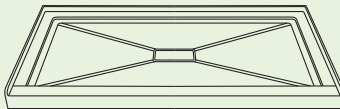

GSB-6032-C

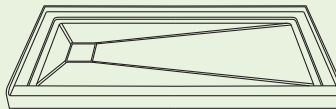

GSB-6032-L

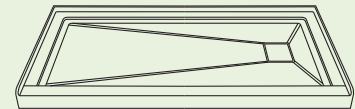

GSB-6032-R

W 72" x D 36"

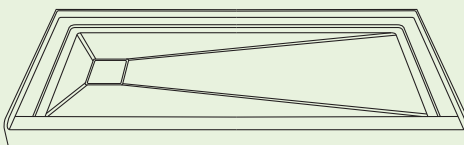

GSB-7236-L

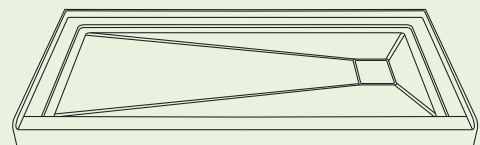

GSB-7236-R



Please read all instructions carefully before proceeding with installation.



Due to the complexity of the installation procedure, a professional plumber is required.

TABLE OF CONTENTS

1. Pre-installation Checklist	P4
2. Tools Required	P5
3. Installation Instructions	P6
4. Care & Maintace	P18
5. Warranty	P20

PRE-INSTALLATION CHECKLIST

Choose the Shower Base:

*Select a shower base that fits your space and matches your design preferences.

Check Local Building Codes:

*Review local regulations regarding plumbing and bathroom renovations to ensure compliance.

Measure the Space:

*Measure the area designated for the shower base (length, width, and height).

*Measure the existing drain to ensure compatibility with the new base.

Inspect the Shower Base:

Opened all the boxes, read the instruction and inspect the shower base thoroughly, ensure all the necessary components are included and no damaged. Do not install the base and contact our service team for support immediately.

Inspect Existing Plumbing:

*Check that the existing drain aligns with the drain hole in the shower base.

*Ensure the plumbing is in good condition and free of leaks.

Adjust Plumbing if Necessary:

Consider hiring a licensed plumber if adjustments are needed to the drain or supply lines.

Inspect the Subfloor:

* Check for damage or not and repair as needed.

* Ensure the subfloor is clean, dry, and free of debris.

Level the Subfloor:

Use a level to ensure the subfloor is even. Address any low spots or bumps.

Dry Fit the Shower Base:

Place the shower base in the intended location to verify positioning and drain alignment.

Additional Considerations

Waterproofing:

* Consider waterproofing measures, like adding a moisture barrier or waterproof membrane if necessary.

Plan for Wall Installation:

* If installing wall panels or tiles, ensure materials are ready and plan how they will be affixed to the walls.

Wear Safety Gear:

* Use safety goggles and gloves during installation to protect against injury.

Clear the Area:

* Remove any obstacles in the bathroom to create a safe workspace.

Time Management:

* Set aside sufficient time to complete the installation without rushing.

Cleanup Supplies:

* Have towels or cloths handy for clean-up during installation.

TOOLS REQUIRED



Level



Jigsaw



Tape Measure



Pencil



Power Drill

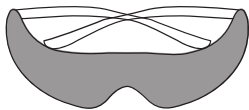

Safety Goggles



3/16" (5mm)
Drill Bit



Screws #8 x 32 mm
(1 1/4" Stainless Steel)



Construction
Adhesive



Mortar
Compound

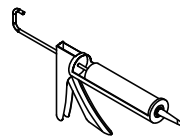

Silicone Caulk

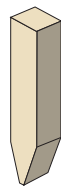

Furring Strips

INSTALLATION INSTRUCTIONS

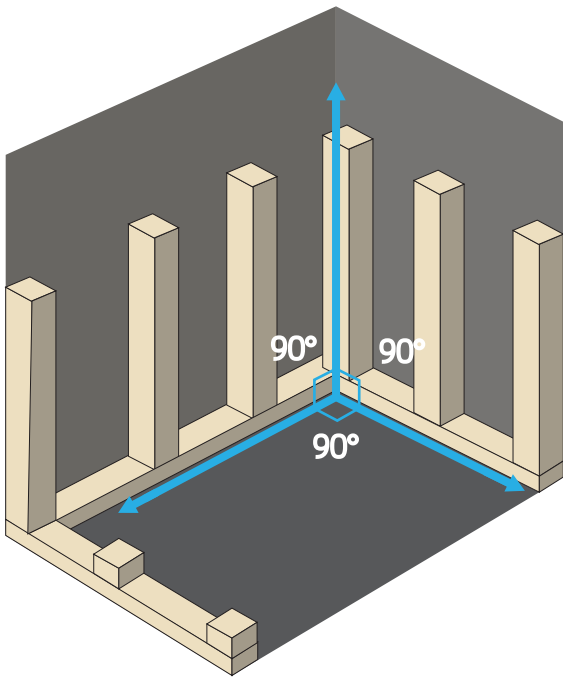

Step1

Set up the studs frame for the shower base area, it's probably measured with the angle finder, and make sure the corner and platform are 90° .

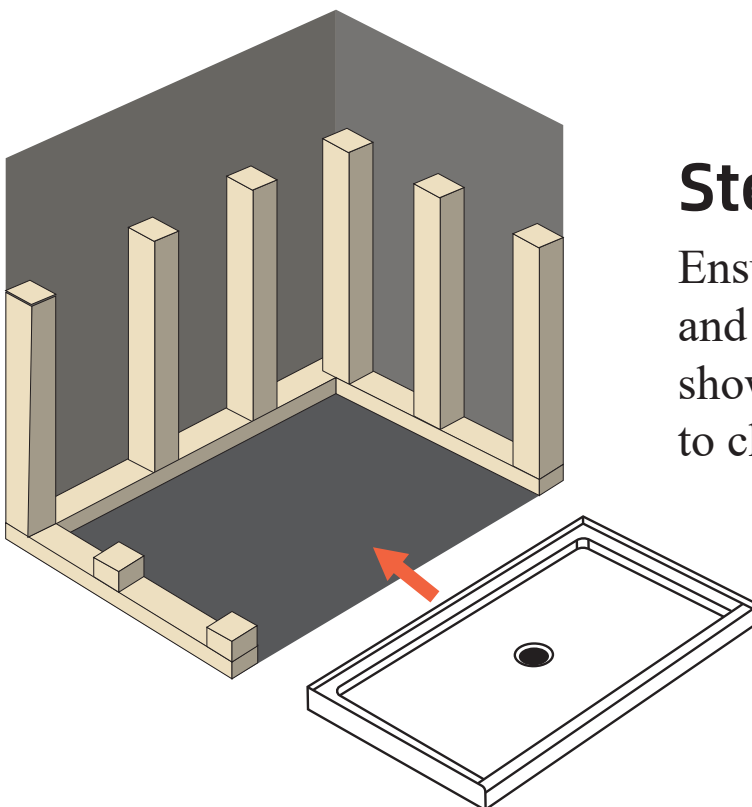

Step2

Ensure the subfloor is clean, dry and structurally sound. Place the shower base in the desired position to check for fit.

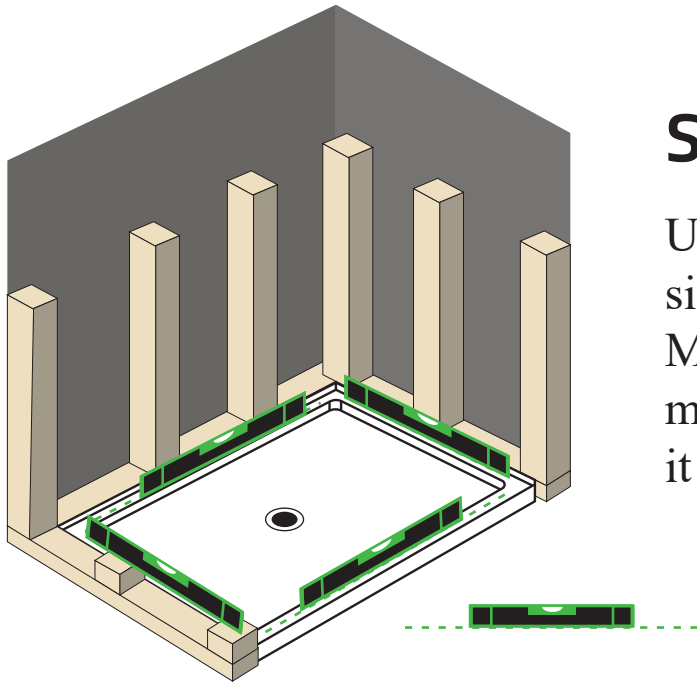

Step3

Use the level to check that the 4 sides of the shower base are leveled. Make sure all sides are leveled. You might need to adjust the subfloor if it wobbles or is not flat.

Step4

Mark the location of the drain outlet and the shower base.

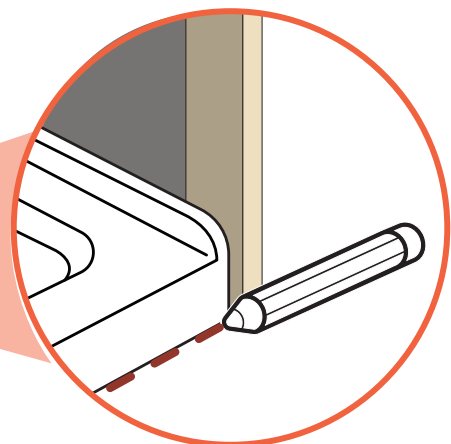
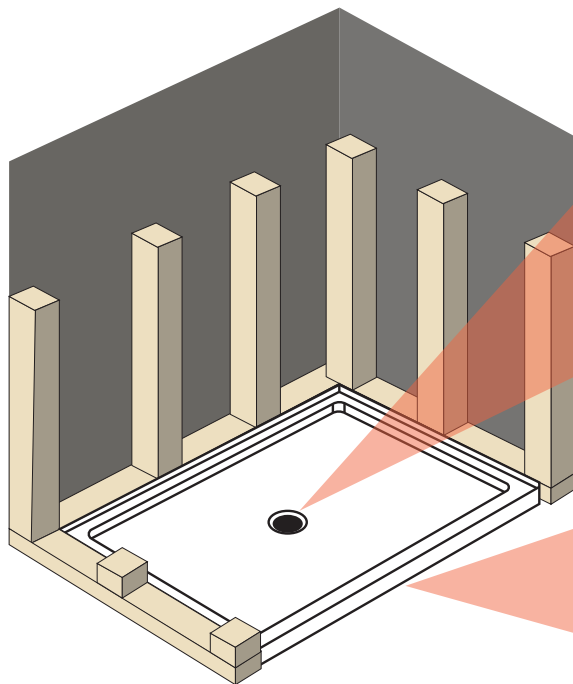

Step 5

According to the marked drain location, cut a 10" × 10" opening in the subfloor.

Leave 2–5 inches of clearance around the drain pipe for adjustment. Ensure the 2-inch waste pipe is centered within the opening and extends 2 inches above the floor.

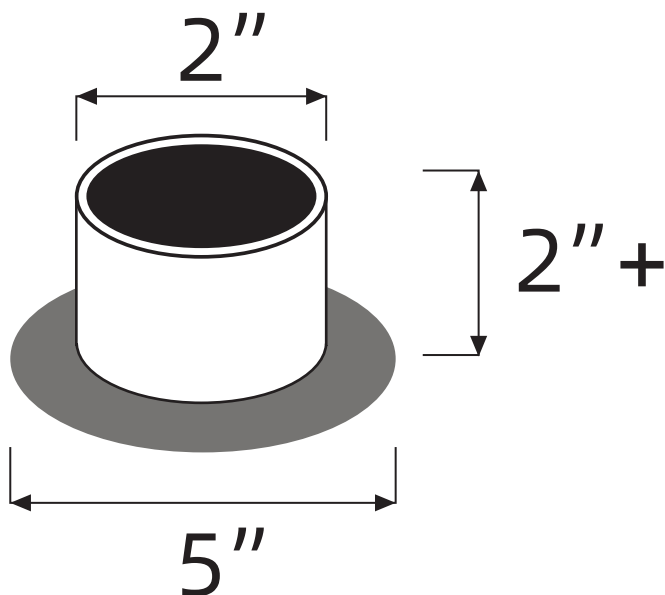
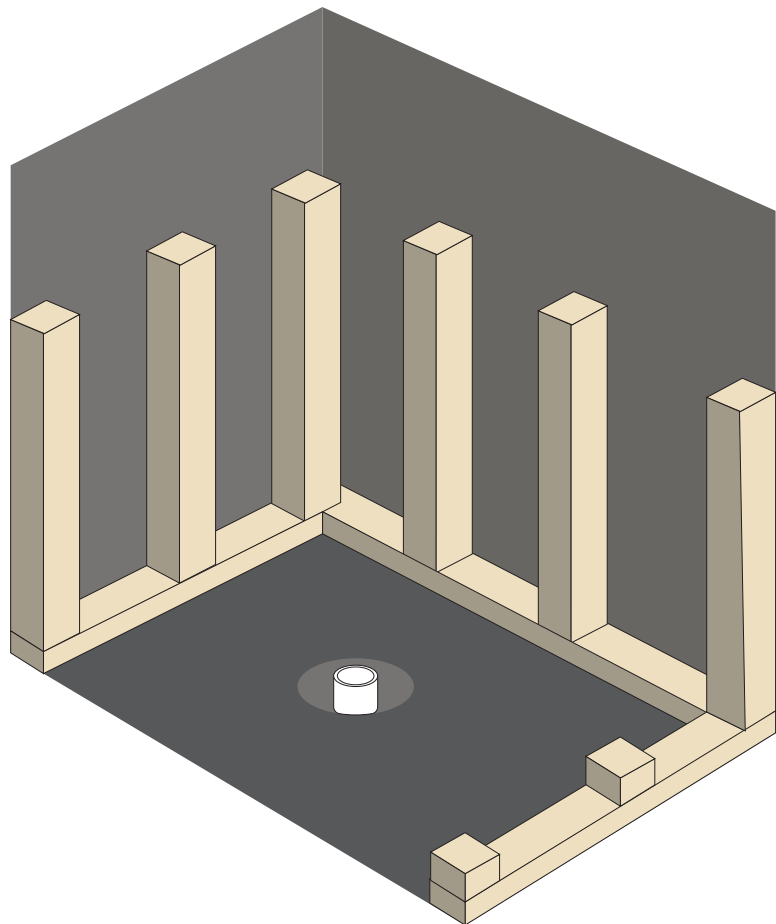
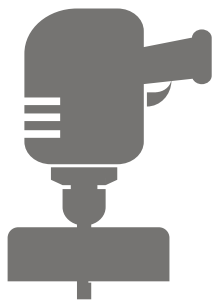

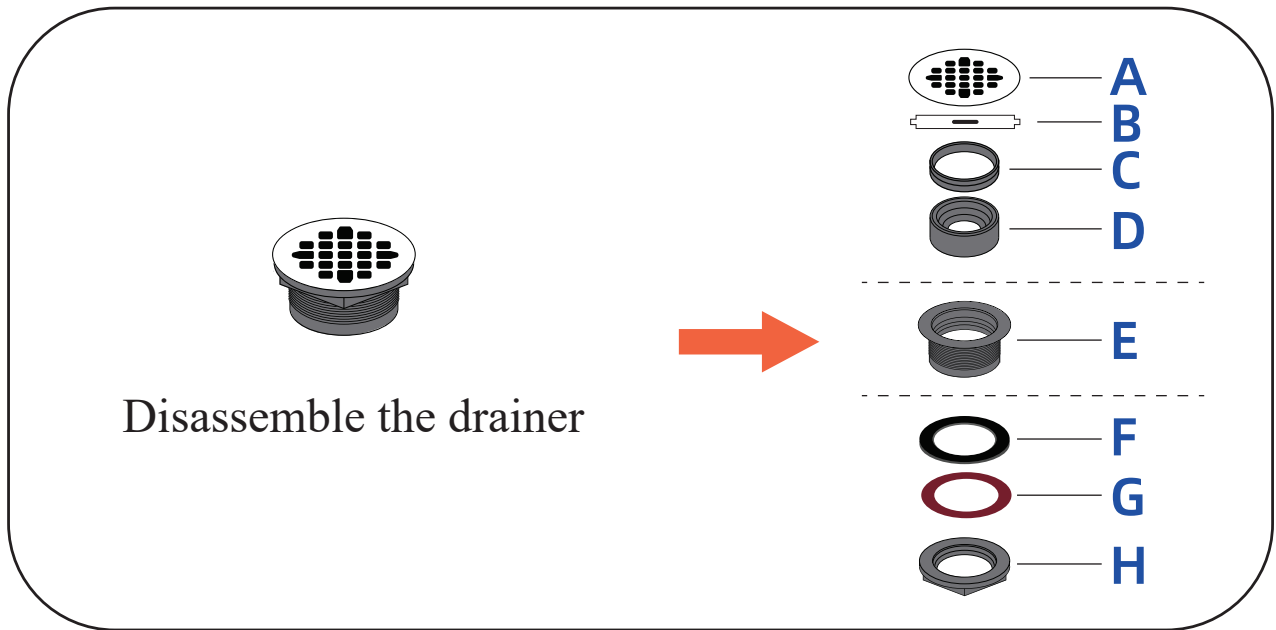

Step6

According to the instructions, pre-install the drain assembly on the base. Apply plumber's putty under the drain flange before securing it to ensure a watertight seal.

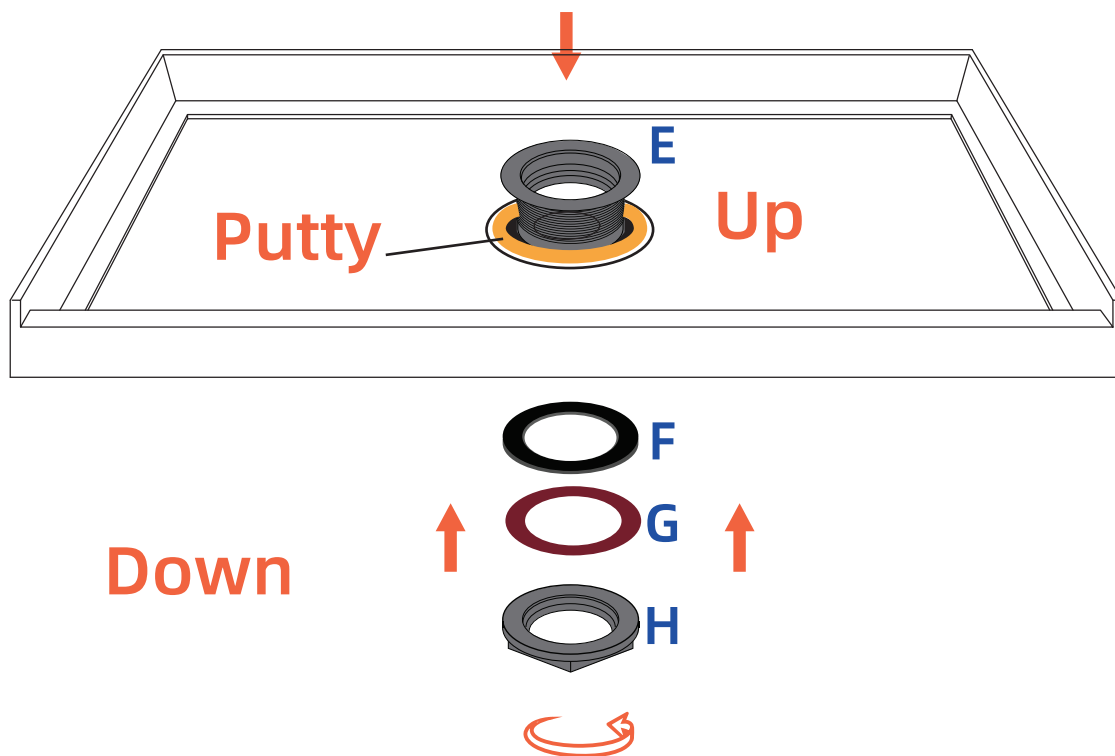

Step 7

Apply a layer of thin-set mortar or construction adhesive to the area where the shower base will sit, use a notched trowel for even application.

Tips

To achieve better waterproofing, it is recommended to lay a layer of waterproofing material before applying the mortar.

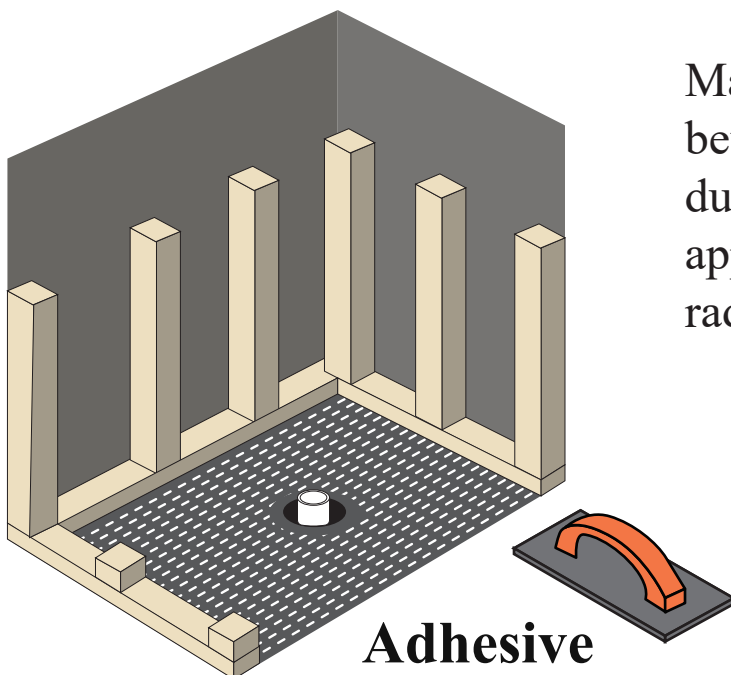
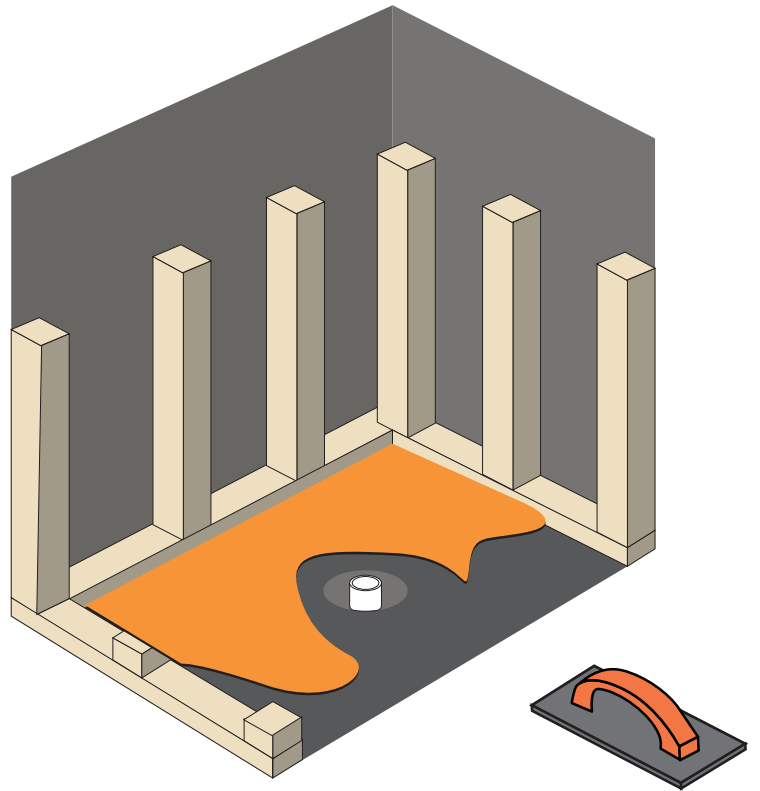

Make sure to avoid any contact between the adhesive and the drain during the installation process. Avoid applying adhesive within a 5-inch radius of the drain area.

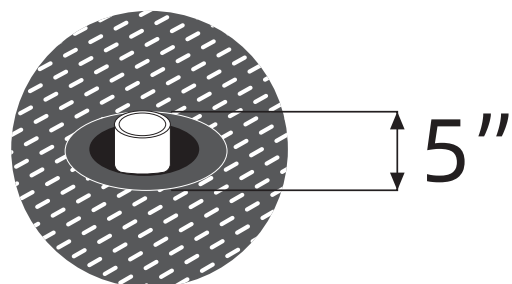

Step 8

Carefully place the shower base onto the bedding material, pressing down firmly to ensure a good bond. Check again for levelness and adjust as needed.

Connect the drain pipe beneath the floor to the drain assembly on the shower base.

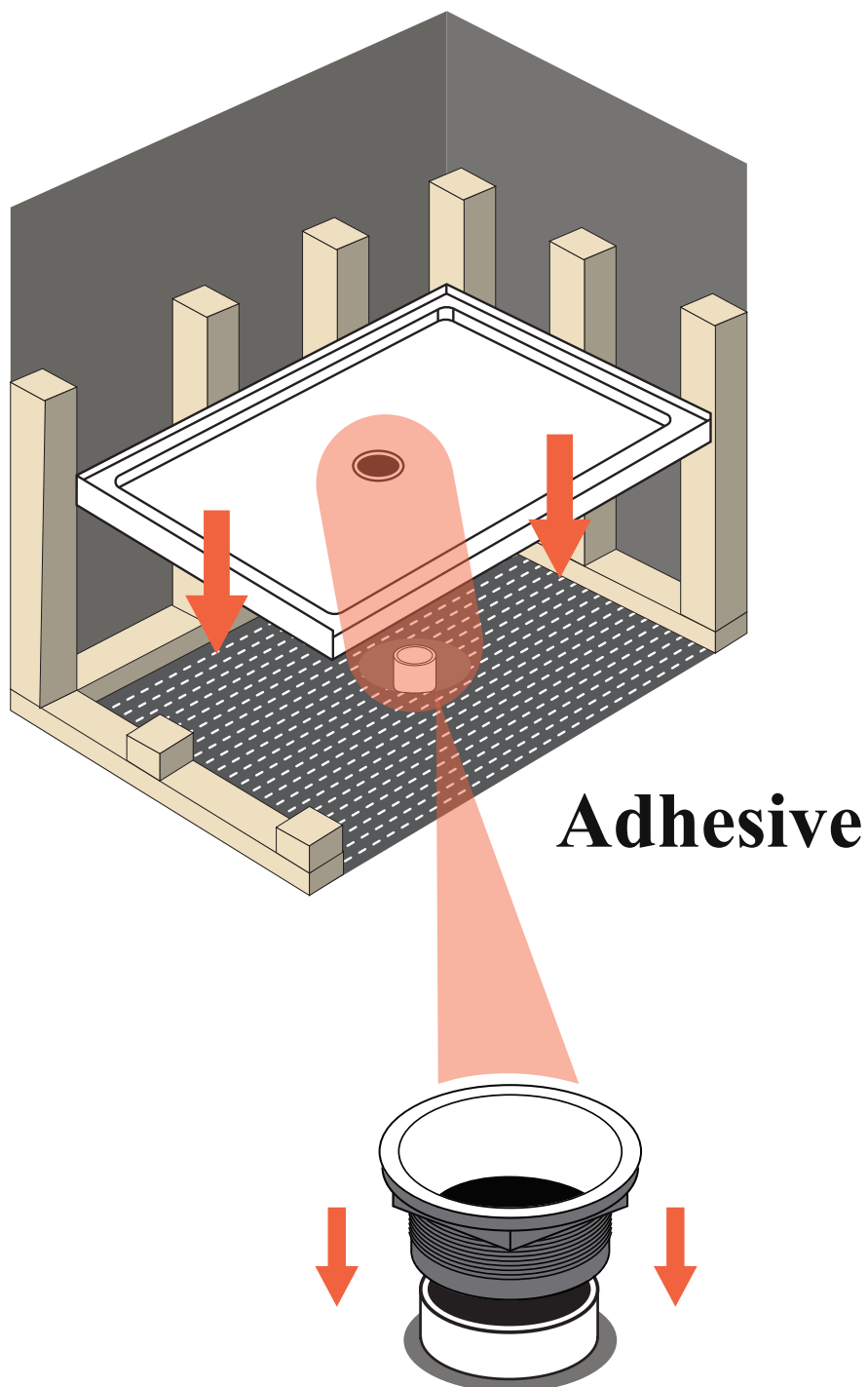

Step9

Use the level to check that the 4 sides of the shower base are leveled. Make sure all sides are leveled. You might need to adjust the subfloor if it wobbles or is not flat.

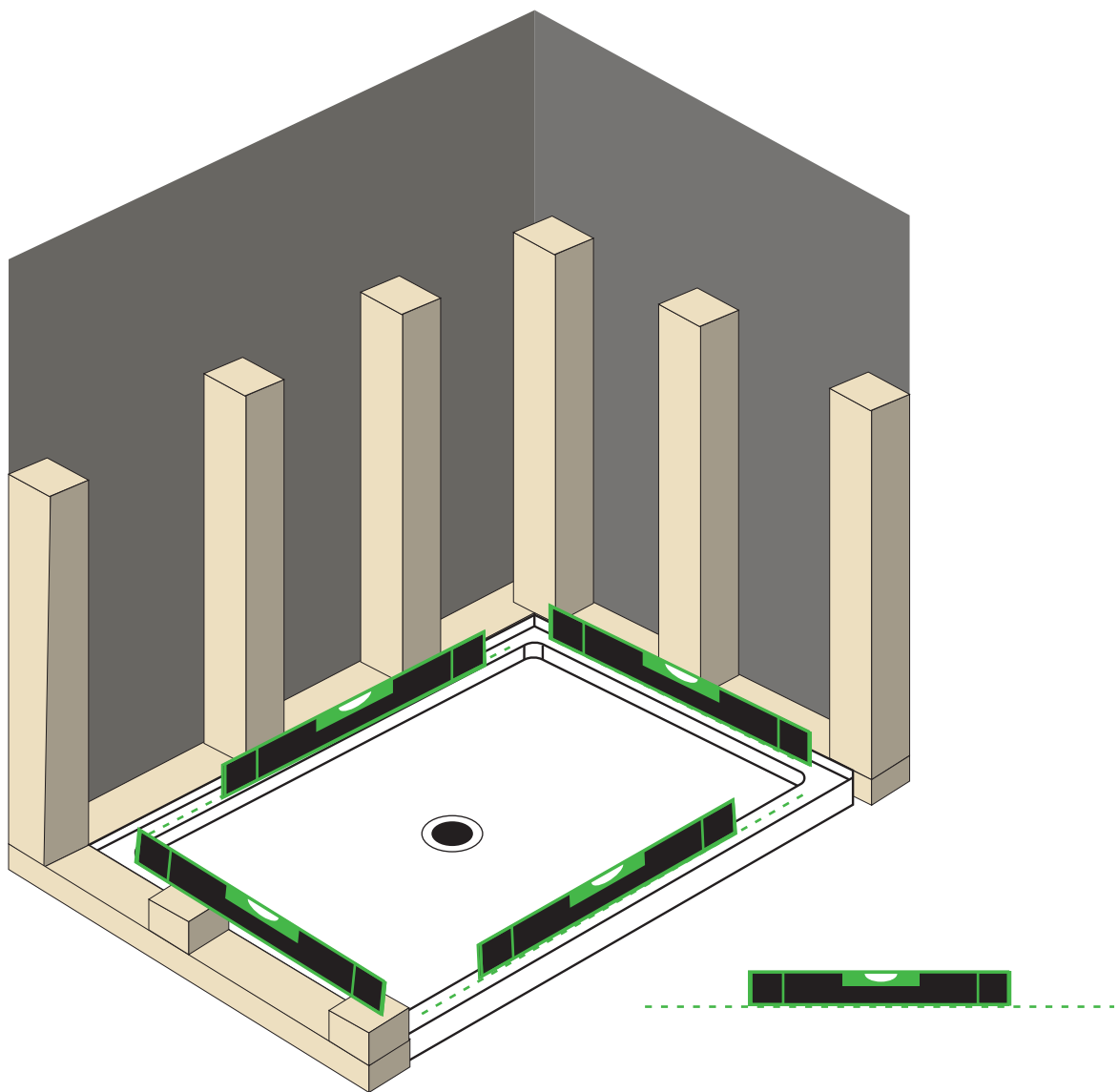

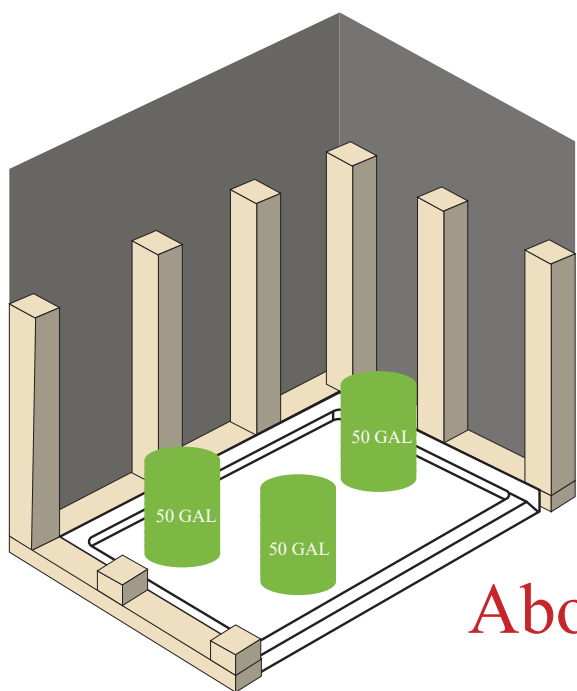

Step 10

If shower base uneven, apply weight to any uneven areas and leave it in place for at least 4 hours or longer to ensure proper leveling.

Above 4 Hours

Step 11

Remove the weights and check the drain opening. Cut the drain pipe so it is flush with the top of the rubber gasket using an inside pipe cutting tool.

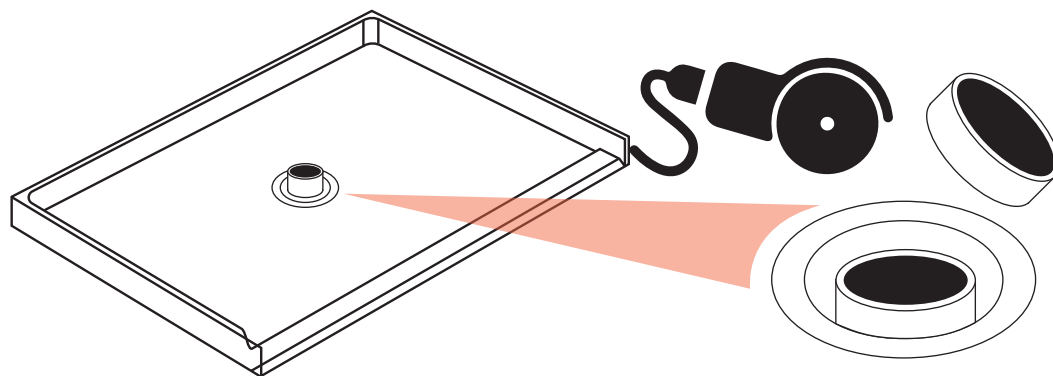

Step12

Apply plumber's grease to the inside of the rubber gasket.
Slide the rubber gasket over the drain pipe with the beveled edge facing down.

Press firmly to ensure the gasket is fully seated and the drain connection is secure.

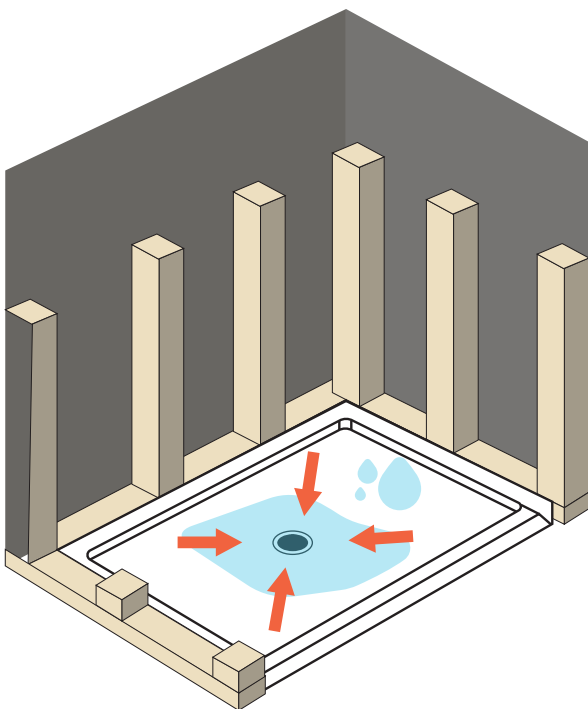
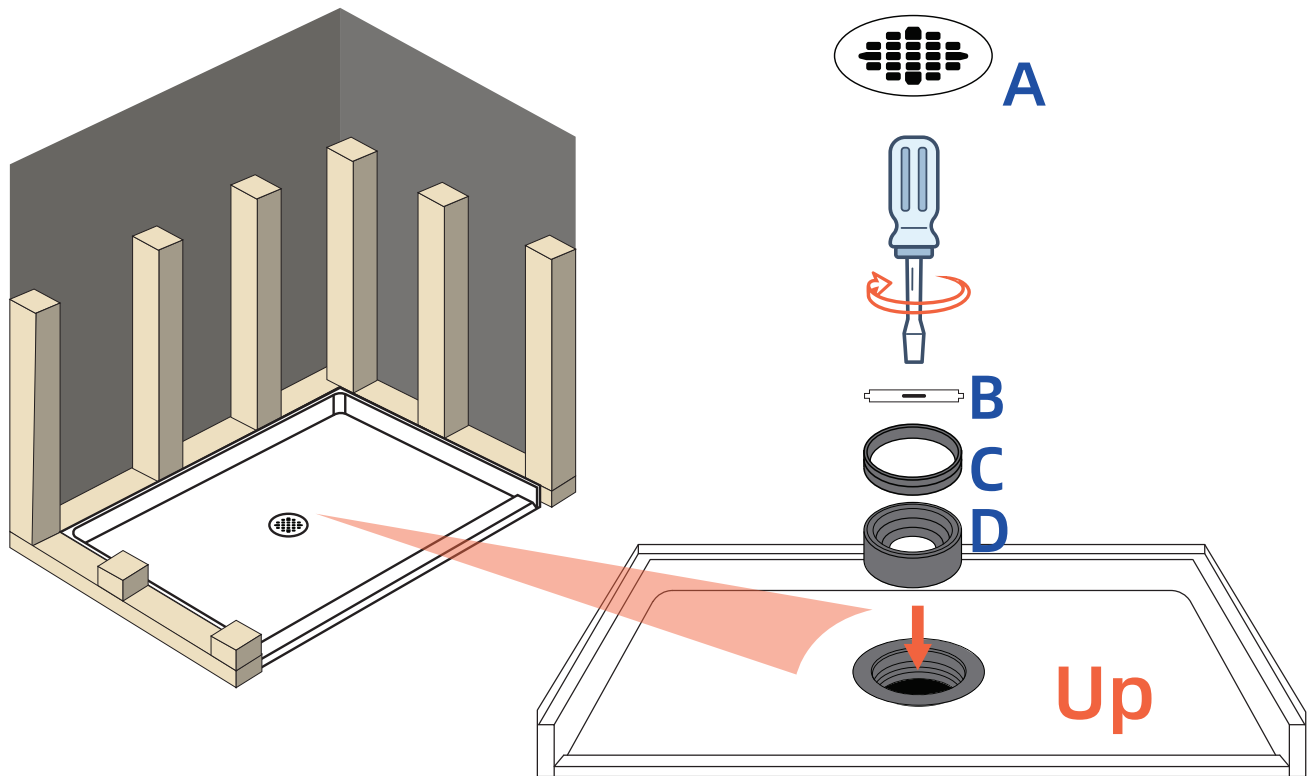

Step13

Test whether the drainage is smooth.

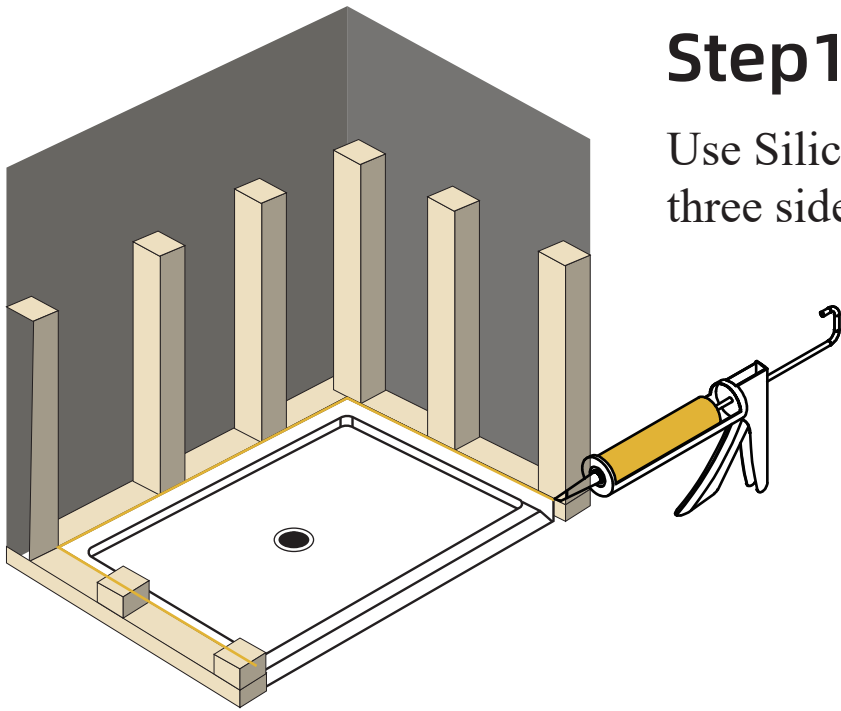

Step14

Use Silicone Caulk to waterproof the three sides.

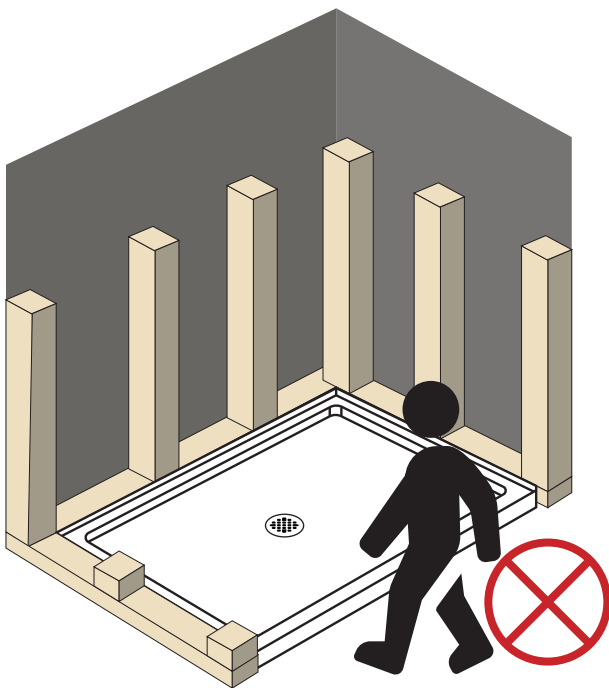

Step15

Allow your shower base to cure for at least 24 hours or follow the drying and curing times recommended by the adhesive and caulk manufacturers before placing any weight on the bottom of the shower base.

 24 hours

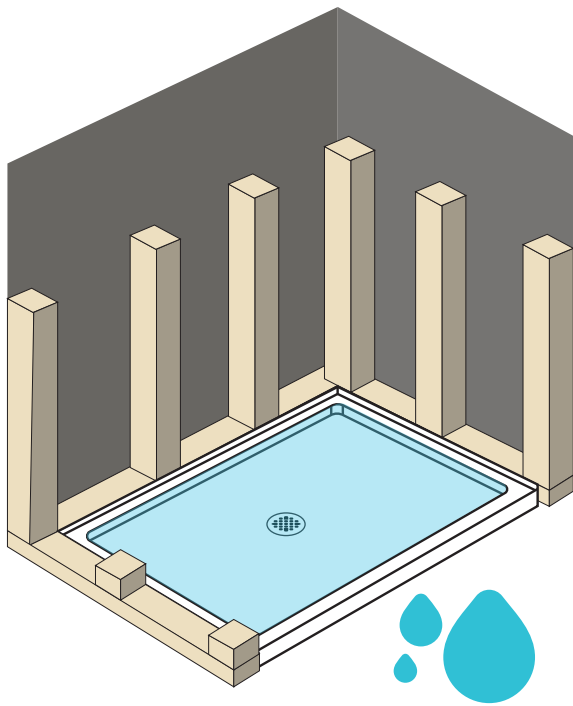

Step16

Water test for the drain and plumbing, plugged the drain, fill the shower base with a few inches of water, and check underneath the base, especially around the drain and seams, for any signs of water leakage, after letting the water sit for 30 mins, unplug the drain and ensure water drains properly without any abstraction.

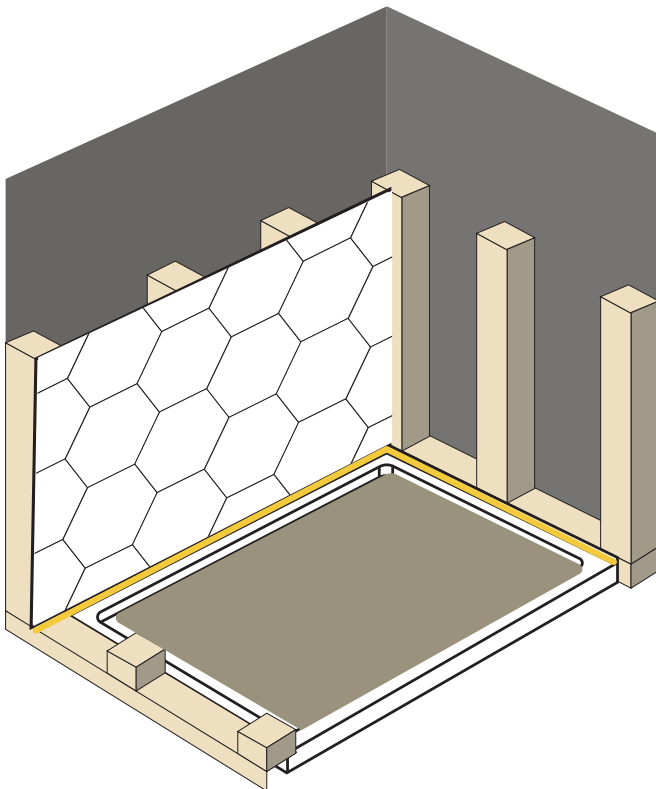

Step17

When decorating the walls, the surface of the shower base needs to be covered with other materials to prevent scratches.

Step18

Kindly Reminder: There is a transparent protective film on the base surface, please don't forget to tear it off before actual use.

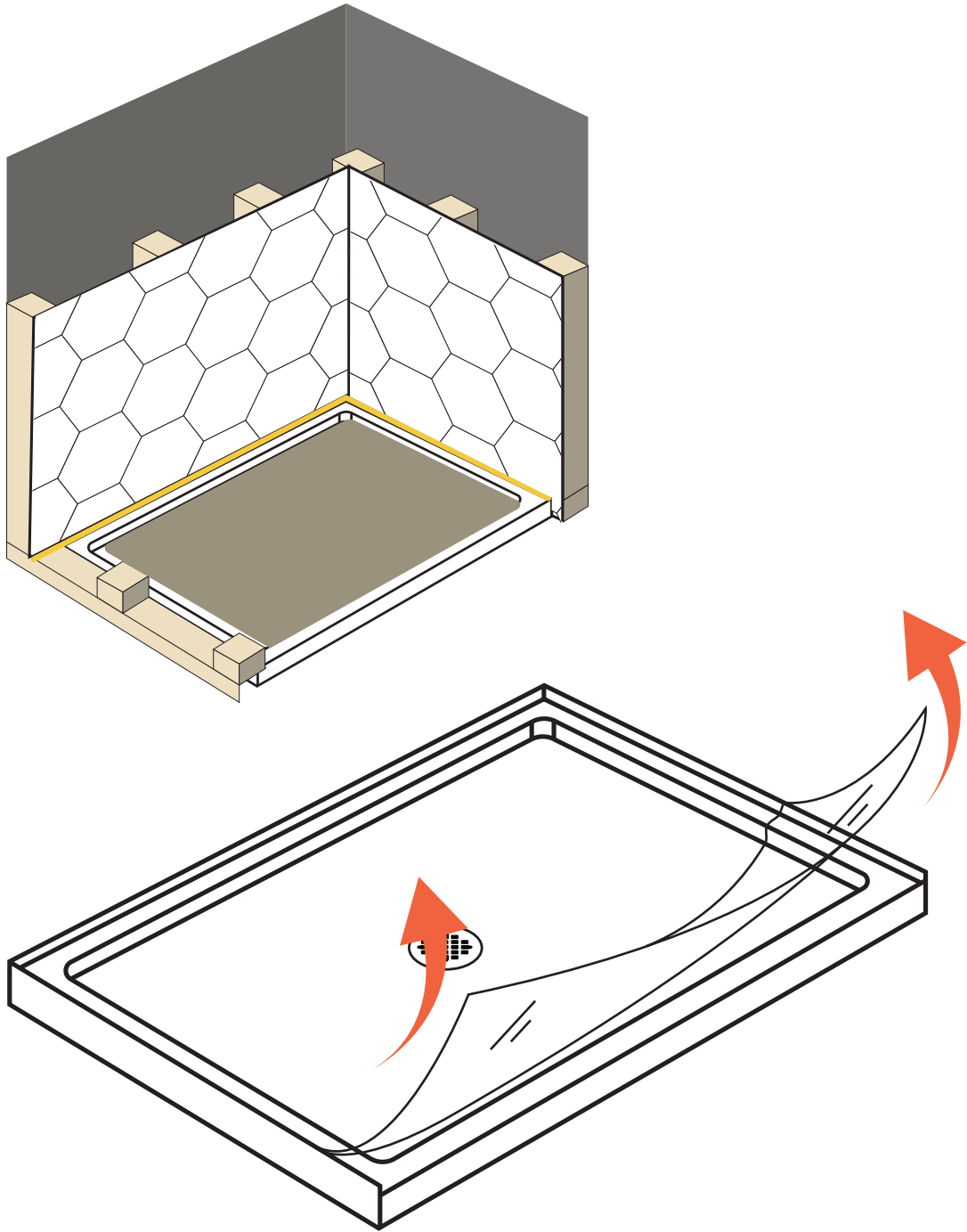

CARE & MAINTACE

Maintaining an acrylic shower base is relatively easy and can help prolong its lifespan while keeping it looking good. Here are some effective maintenance tips:

1. Regular Cleaning:

- **Use Mild Cleaners:** Clean your acrylic shower base regularly with a mild, non-abrasive cleaner. Avoid harsh chemicals, bleach, or abrasive scrubbers, as these can scratch or damage the surface.
- **Soft Cloth or Sponge:** Use a soft cloth, sponge, or a non-abrasive scrub pad for cleaning. This will help prevent scratches while effectively removing soap scum and dirt.
- **Rinse After Use:** After each shower, rinse the base with warm water to remove any soap residue and prevent buildup.

2. Preventing Soap Scum and Hard Water Stains:

- **Squeegee After Use:** Use a squeegee to wipe down the walls and shower base after each use. This can help minimize water spots, soap scum, and mineral deposits.
- **Dry the Area:** After squeegeeing, use a soft towel to dry the surface if possible, reducing the moisture that promotes soap scum and mold.

3. Addressing Stains:

- **Baking Soda Paste:** For tough stains, create a paste with baking soda and water, apply it to the stain, let it sit for a few minutes, and then gently scrub with a soft cloth or sponge.
- **Vinegar Solution:** A mixture of equal parts water and white vinegar can help remove hard water stains. Spray the solution on the affected area, let it sit for a few minutes, then rinse and wipe clean.

4. Avoiding Damage:

- **No Abrasive Tools:** Avoid using steel wool or harsh scrubbing pads, as they can scratch the acrylic surface.
- **Hot Items:** Never place hot items directly on the acrylic surface, as extreme heat can cause warping or damage.
- **Avoid Heavy Impacts:** Be cautious not to drop heavy objects onto the shower base, as this can cause cracks or dents.

5. Check for Cracks or Damage:

- **Regular Inspections:** Periodically inspect the shower base for any signs of cracks, chips, or discoloration. If you notice damage, address it promptly to prevent further issues.
- **Repair Kits:** If you find a small crack or chip, consider using an acrylic repair kit specifically designed for fixing minor damage to acrylic surfaces.

6. Maintain Surrounding Areas:

- **Seal Grout Joints:** If your shower base is part of an enclosed unit with tile walls, make sure the grout joints are sealed to prevent moisture from seeping behind and causing damage.
- **Check Caulking:** Regularly inspect the caulking around the shower base. If you notice it cracking or peeling, remove the old caulk and reapply new silicone caulk to prevent water leakage.

7. Use a Shower Mat:

- **Non-Slip Mat:** Consider using a non-slip shower mat or rug in your shower to protect the base from scratches and provide added traction.

8. Avoiding Heavy Cleaning:

- **Limit Strong Chemicals:** Avoid using harsh chemicals, bleaches, or products containing alcohol or ammonia, as these can degrade the acrylic over time.

LIMITED WARRANTY COVERAGE

1 YEARS LIMITED WARRANTY

NTQ products are made with quality materials and excellent craftsmanship to provide the customers a long-lasting product. In the case of any defects in materials or craftsmanship under regular use were inspected in the first one year of delivery, NTQ will provide replacement parts at no charge, or at its option, replace any product or part of the product that is deemed defective, under normal installation, use, service and maintenance. This warranty applies only to the original purchaser. Proof of purchase will be required in the case of a claim.

ZEAFIVE will, as its option

- (1) Repair or replace the defective part(s) or product(s) at no charge;
- (2) Issue a refund of the original purchase price of the product(s) (Valid within 30 days from the date of delivery);
- (3) Issue a credit to be applied toward the purchase of a new NTQ product shipping/delivery charges may apply and are in NTQ's sole discretion.

NTQ recommends the installations to be made by a licensed, professional plumber. NTQ will not be held responsible for any damage or product failure due to improper installation, misuse, or failure to use a licensed professional. NTQ is not responsible for any removal or installation cost.

This limited warranty shall not apply to goods that have been subject to accident, negligence, improper installation, product abuse, product misuse, or use of cleaners containing abrasives, alcohol or other organic solvents, whether performed by a contractor, service company, or yourself, are excluded from this warranty.

NTQ responsibility under this limited warranty is limited to only to replacement parts and no other costs.

NTQ will not be responsible for labor charges and/or damage incurred by installation, repair, or replacement, nor for any indirect incidental or consequential damages, losses, injury, or costs of any nature relating to this product.

Except as provided by law, this limited warranty is instead of and excludes all other warranties, conditions, and guarantees, whether expressed or implied, statutory or otherwise, including without restriction those merchant ability of fitness for use.

RESPONSIBILITIES OF OTHERS

Inspecting the unit before installation is the responsibility of the installer or building contractor who acts on behalf of the user. They are responsible for ensuring the unit is free of defects or damage.

Notices are placed on and in the unit and on the shipping carton advising the installer of this responsibility. In the event of a problem, the unit must not be installed.

NTQ is not responsible for failures or damage that could have been discovered, repaired, or avoided by proper inspection and testing before installation.

Damage occurring in transit is the responsibility of the carrier. The user or installer **MUST** open the crate and inspect the unit for damage when it's delivered. If damage is discovered, it must be reported immediately to the seller and the carrier in writing, and an inspection requested. Failure of the carrier to respond should be reported to the seller and the carrier. Your freight claims should be filed promptly thereafter.

LIMITATIONS AND EXCLUSIONS

This warranty does not cover instances of negligence, misuse, abuse, improper installation, carelessness, accident, hard water or mineral deposits, exposure to corrosive materials, misapplication, damages caused by improper maintenance, alteration of the product, or failure to follow care or installation instructions enclosed with your product.

This warranty is void if the NTQ is subject to alteration, or if repairs are attempted by anyone other than an authorized agent of NTQ. This warranty does not extend to plumbing or components installed by dealers, installers or by any party other NTQ.

NTQ will not be liable for loss of use of the NTQ inconvenience, or any other incidental or consequential costs, expenses, or damages. Please note that some states do not allow the exclusion or limitation of incidental damages.

DISCLAIMER

Except as expressly provided, there shall be no warranty or obligation, express or implied, oral or statutory. No dealer or other person has the authority to make any warranties or representations concerning NTQ or its products. In no event shall NTQ be held responsible for any such warranties or representations.

WARRANTY SERVICE

NOTE: When requesting a warranty, be sure to have the following:

- Copy of original invoice
- Date of installation
- Description and pictures of the defect
- Model number or description of the model

To obtain warranty service and replacement parts, please contact NTQ Customer Service.

NTQ will determine whether to repair or replace your product, issue a refund, or issue a credit.

WARNING: Content may contain sharp and other possibly harmful pieces and may cause hazard to children and adults, NTQ is not responsible in any way for personal damage.

HOME SERVICES



INSTALLATION VIDEO

Missing Part or Defective?

Please Contact the Customer Service Team

 support@trendytotesinc.com