

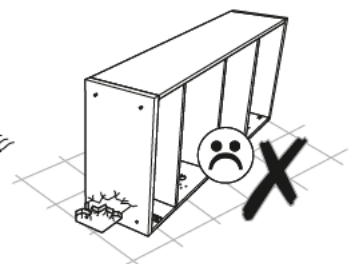

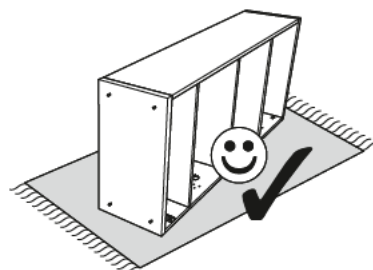

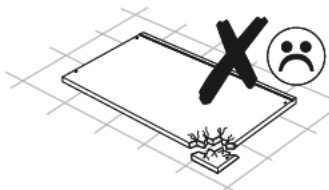

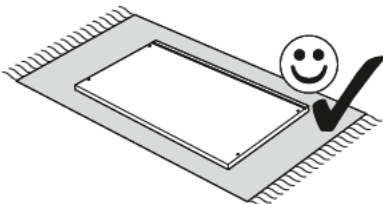

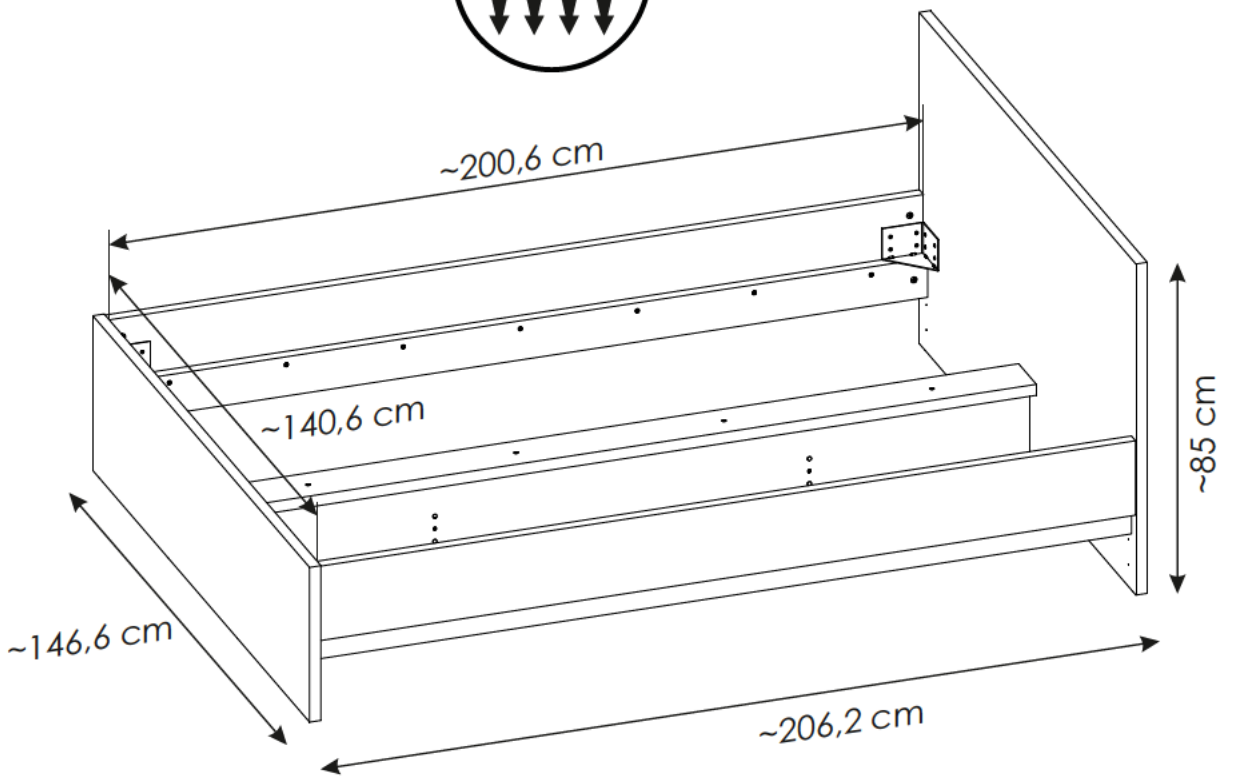
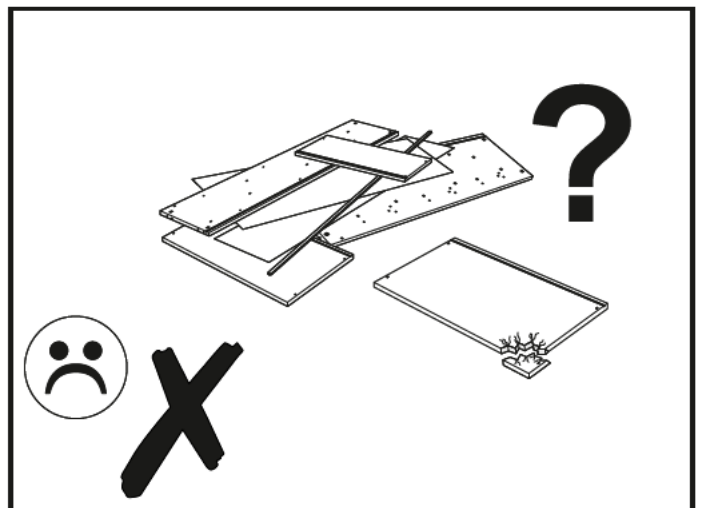
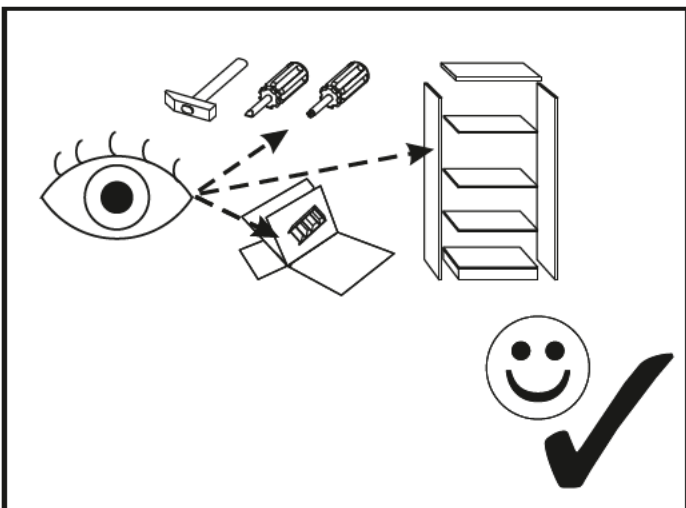
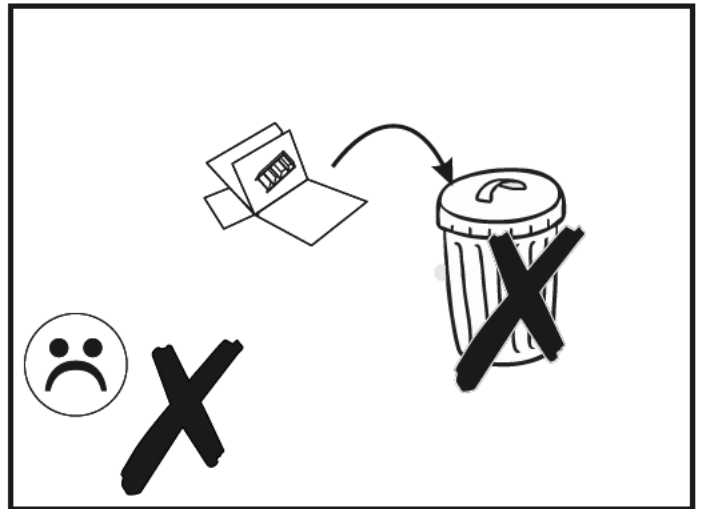
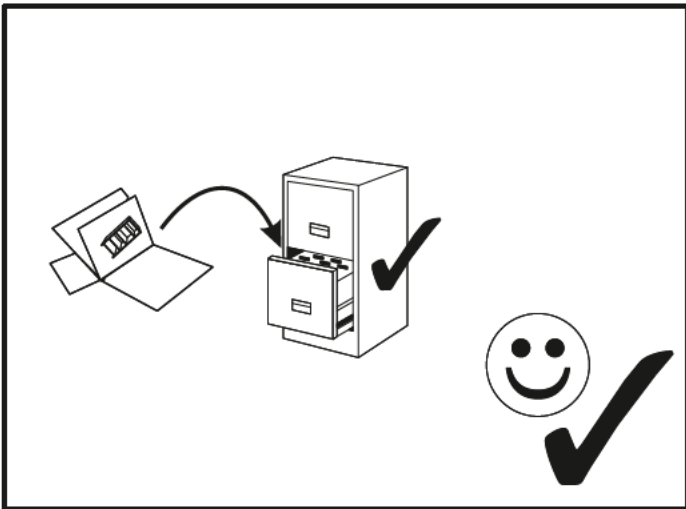
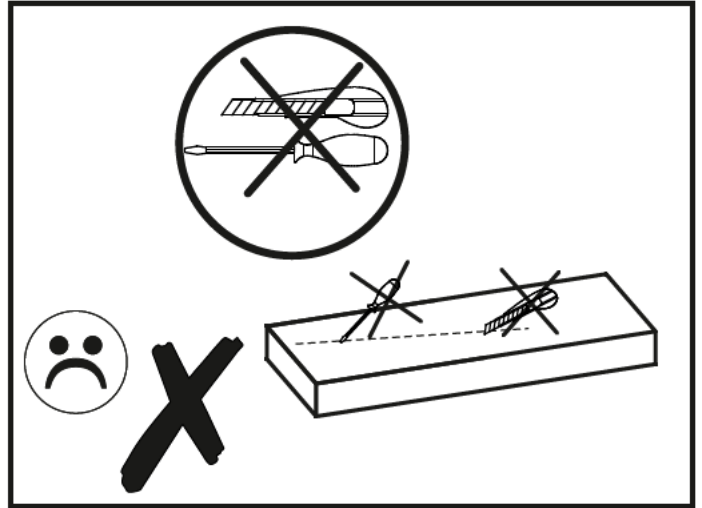
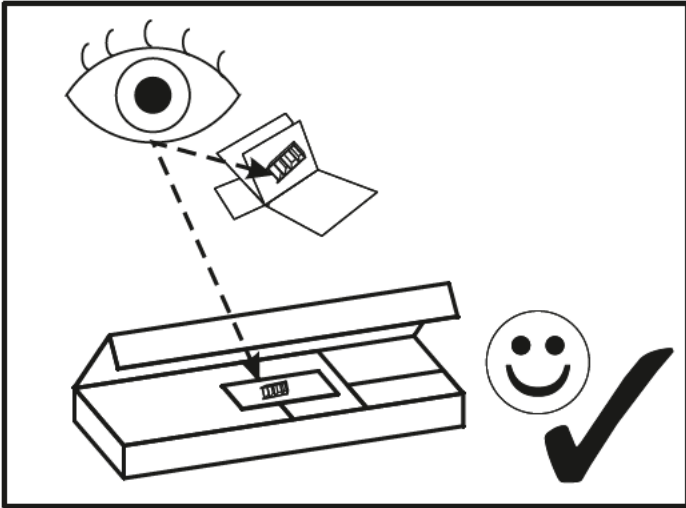

70 min

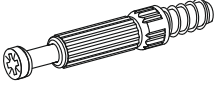

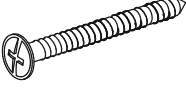
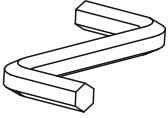
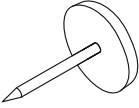

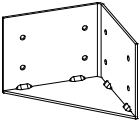
A1 8 x 35 mm x38 	C2 5 x 13 mm x32 	E1 15 x 12 mm x20 
F1 6 x 34 mm x20 	G2 7 x 60 mm x4 	I15 4 x 50 mm x14 
M x1 	O2 x12 	P0 x4  Ø5
P2 x8  Ø8	W x4 	

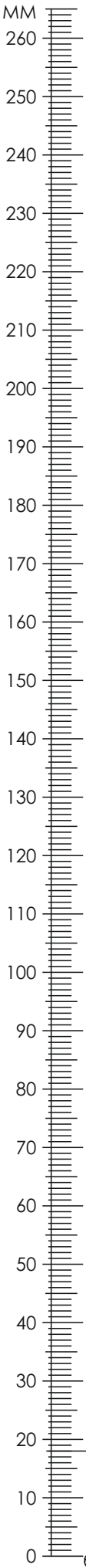

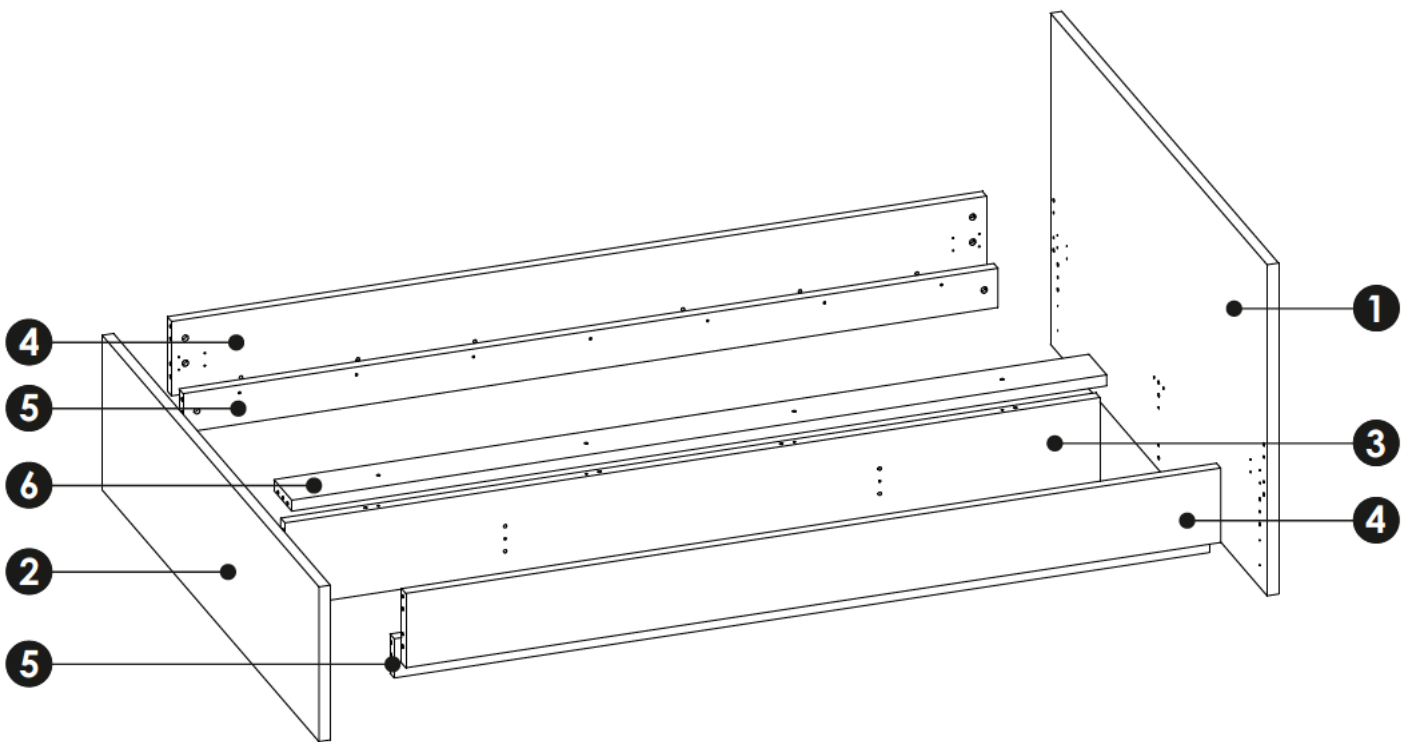
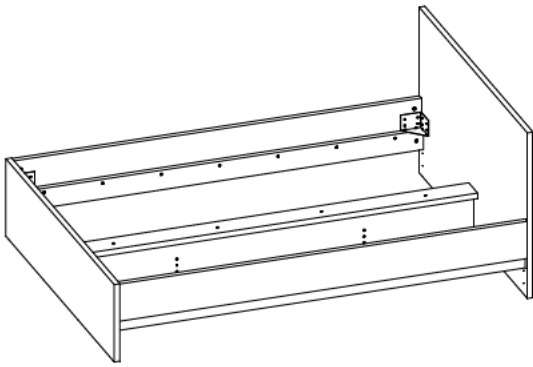

1	1466	845	28	x1	3/3
2	1466	395	28	x1	2/3
3	215	2006	28	x1	2/3
4	2006	190	28	x2	1/3
5	100	2006	28	x2	1/3
6	120	2006	28	x1	2/3

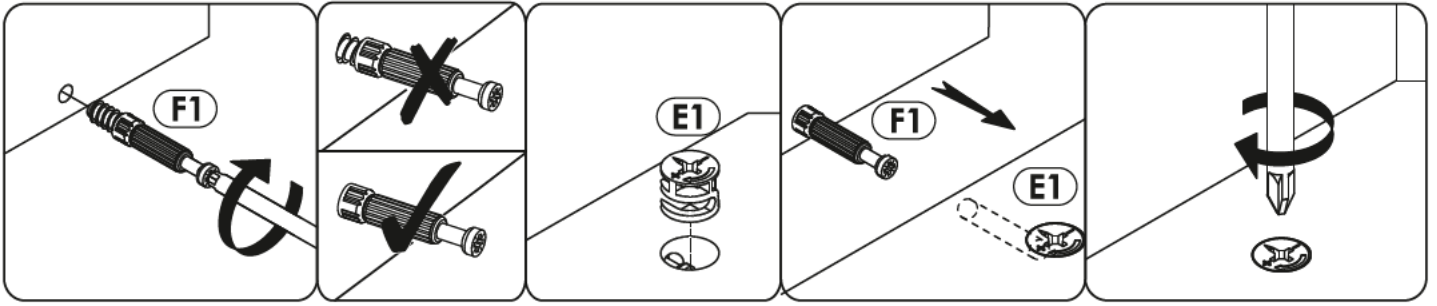

1 ▶

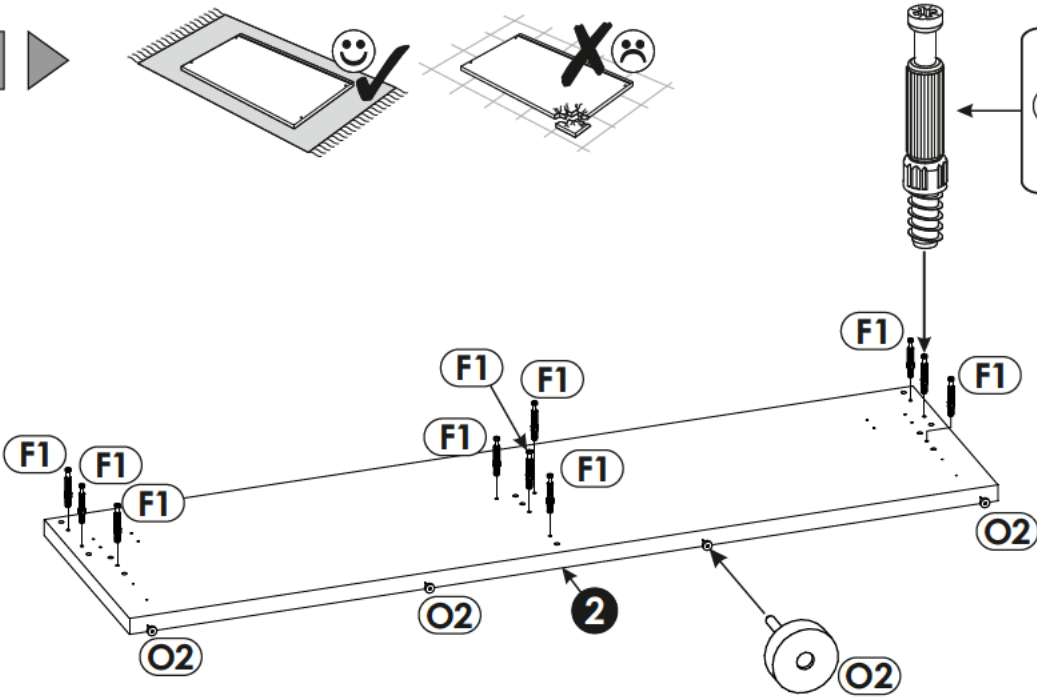
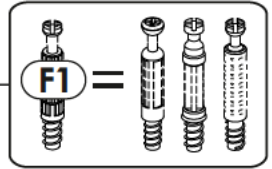
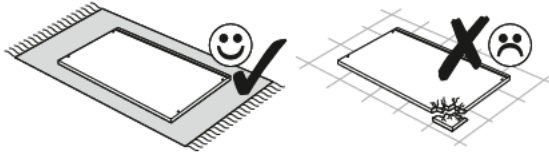

2 ▶

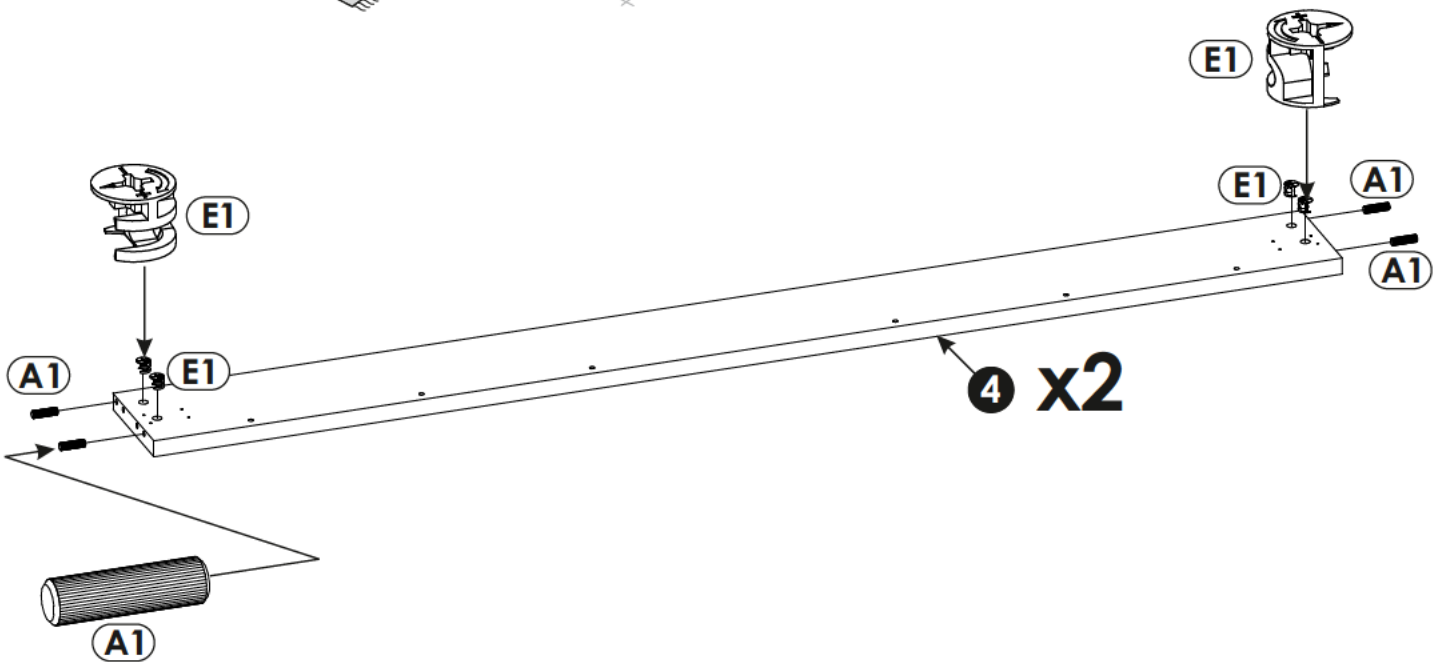
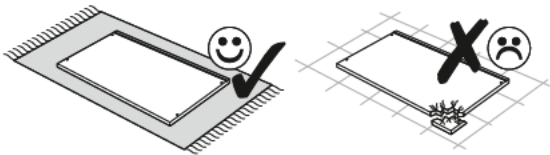

3 ▶

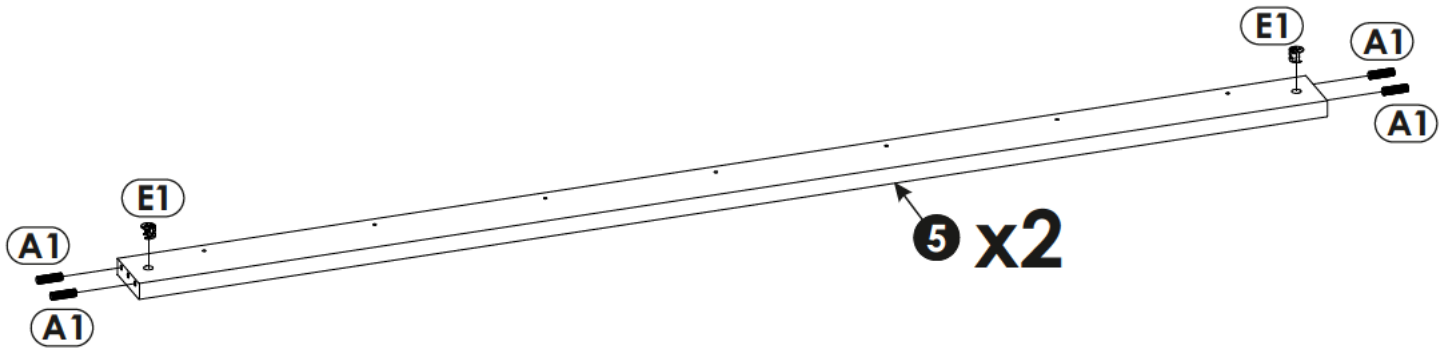
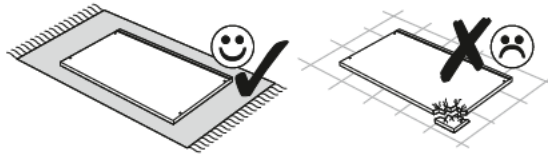

4 ▶

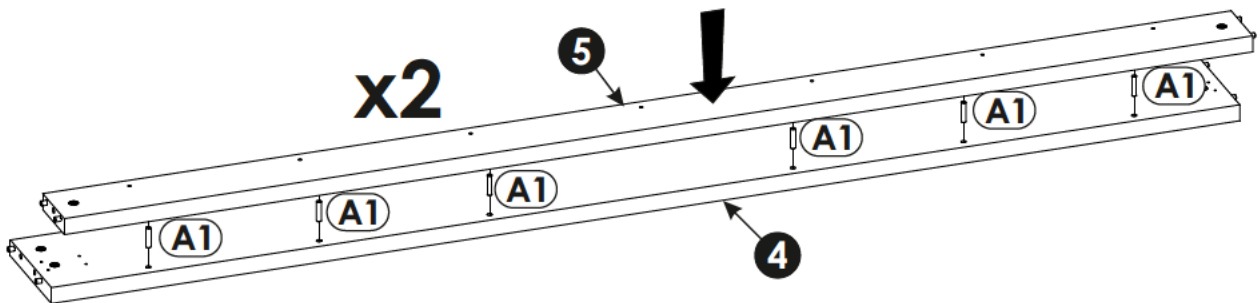
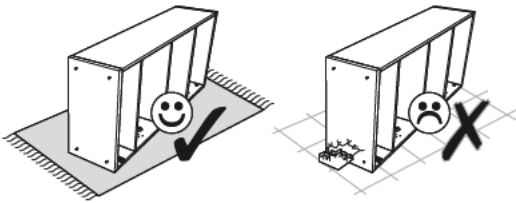

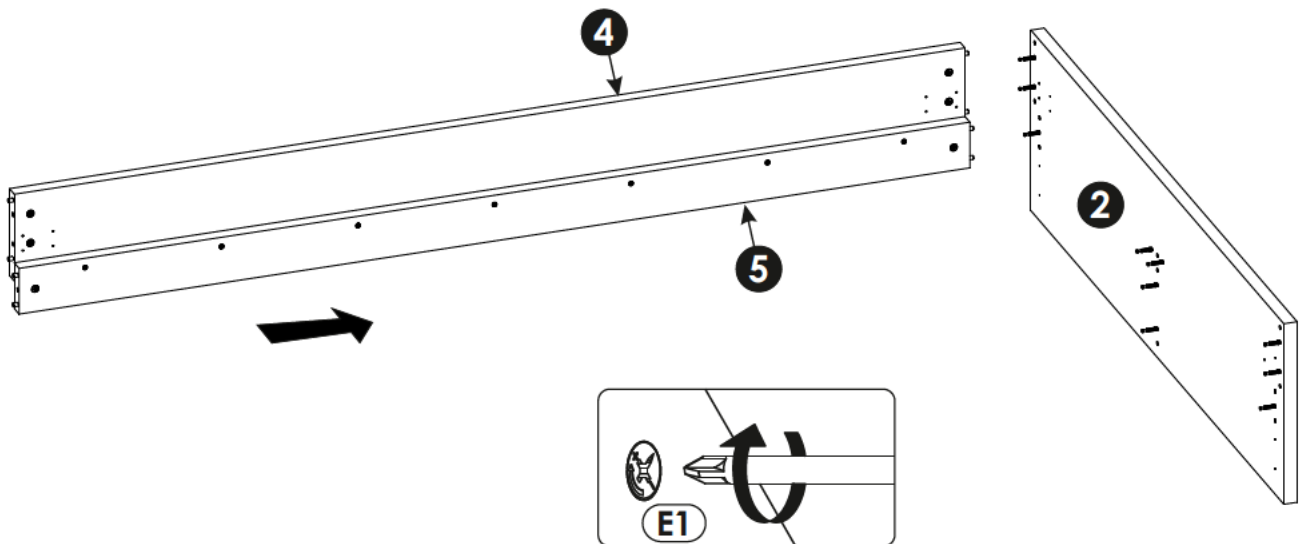
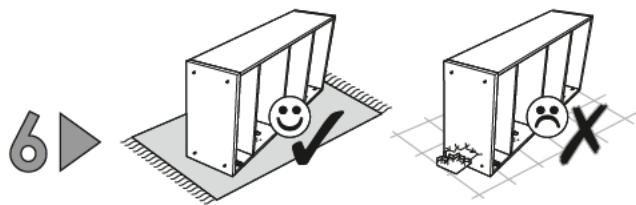
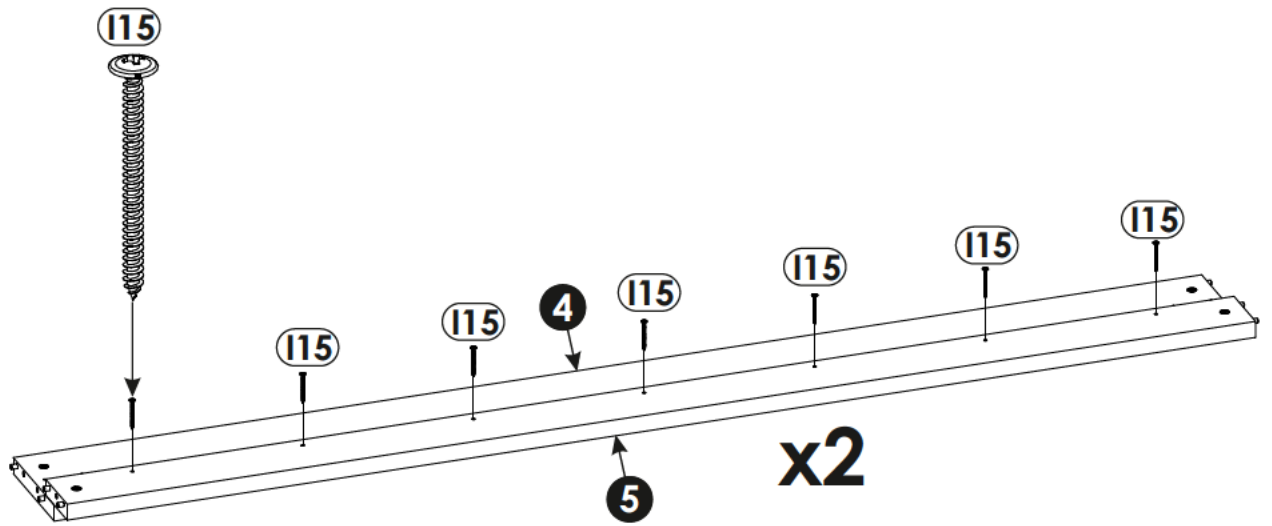
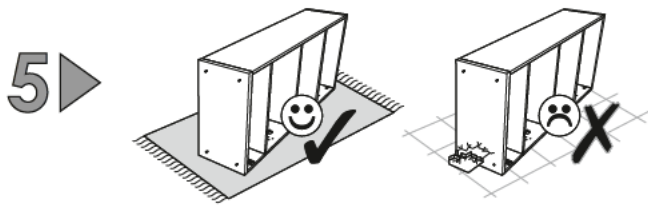

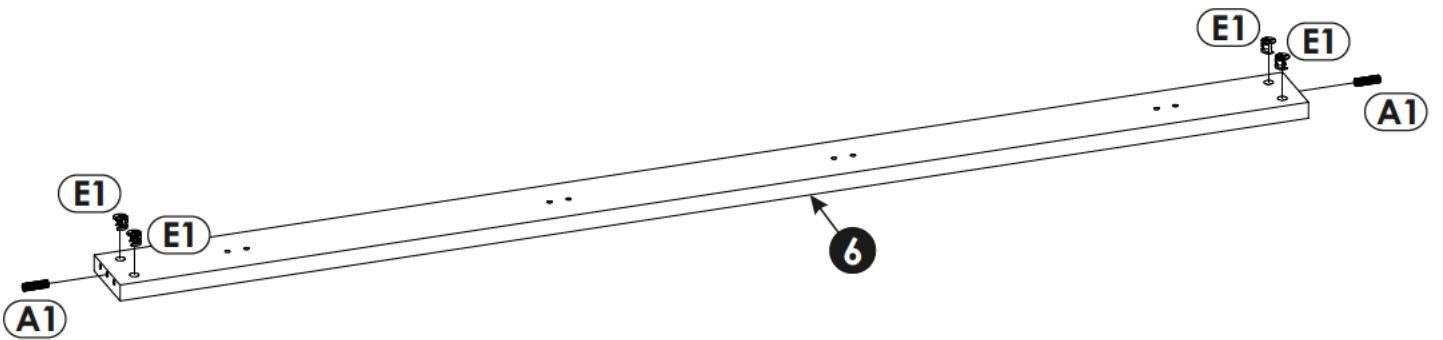
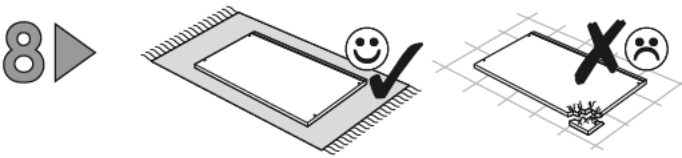
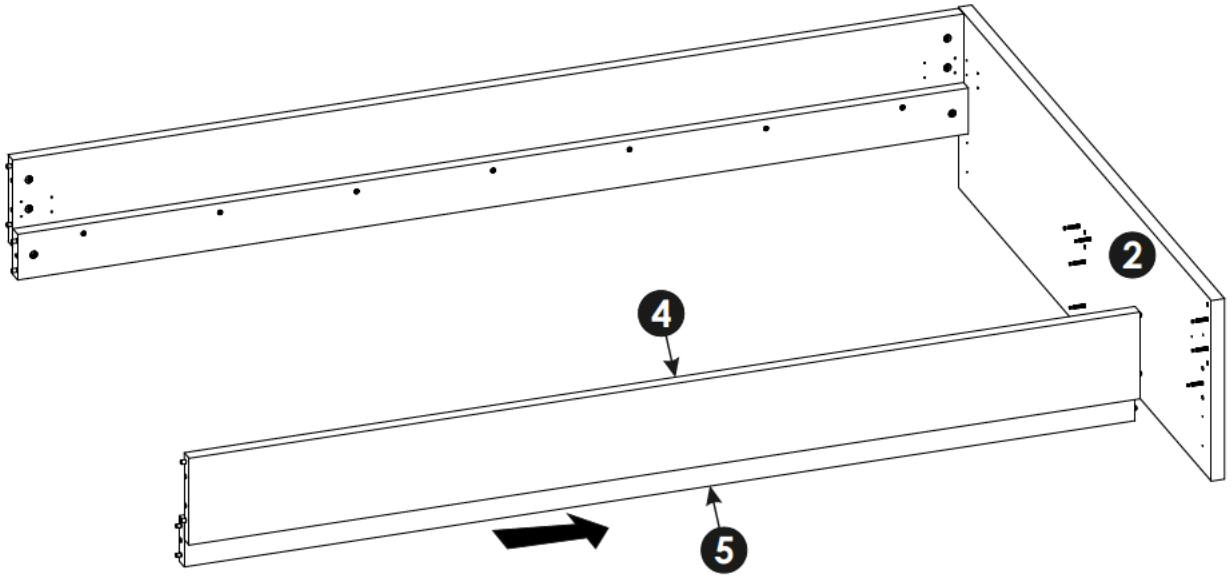
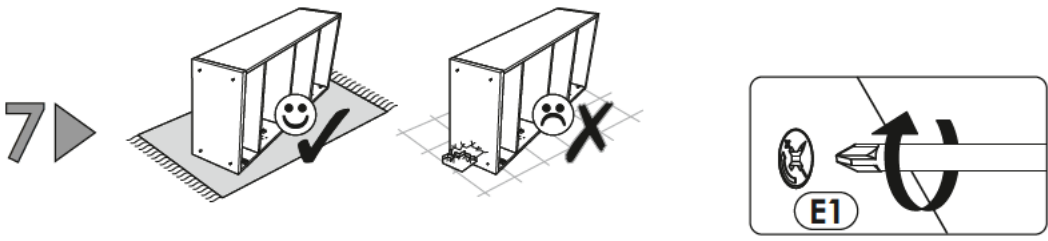

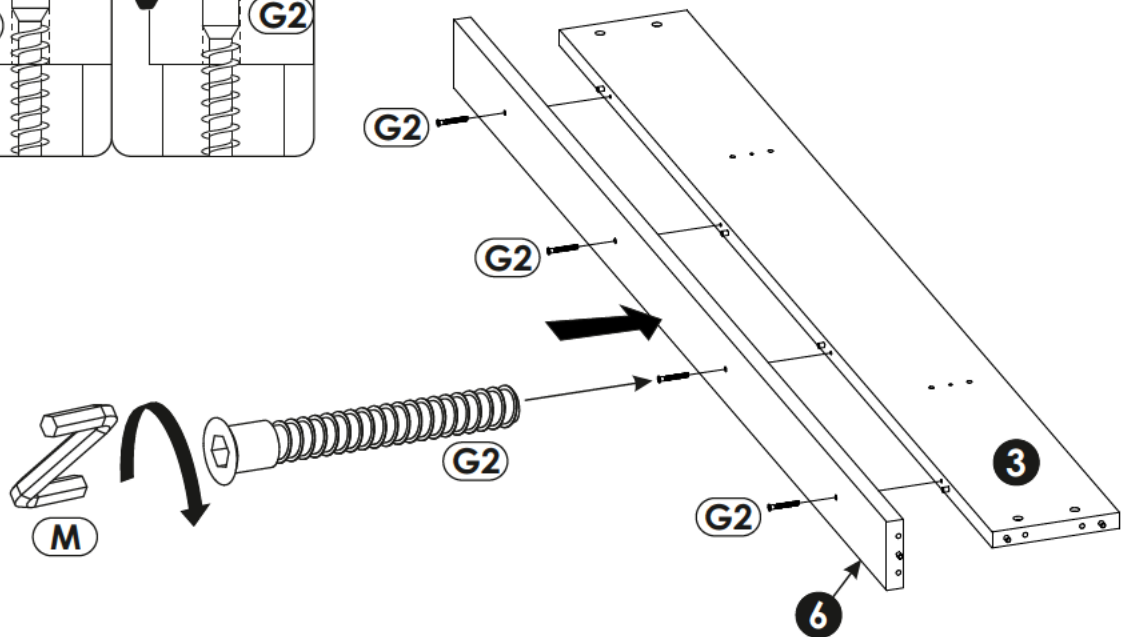
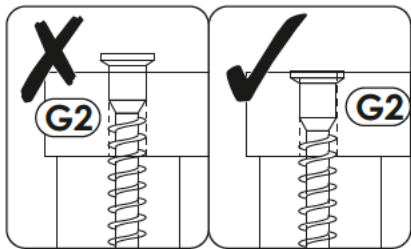
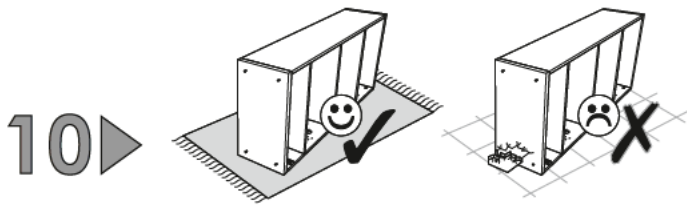
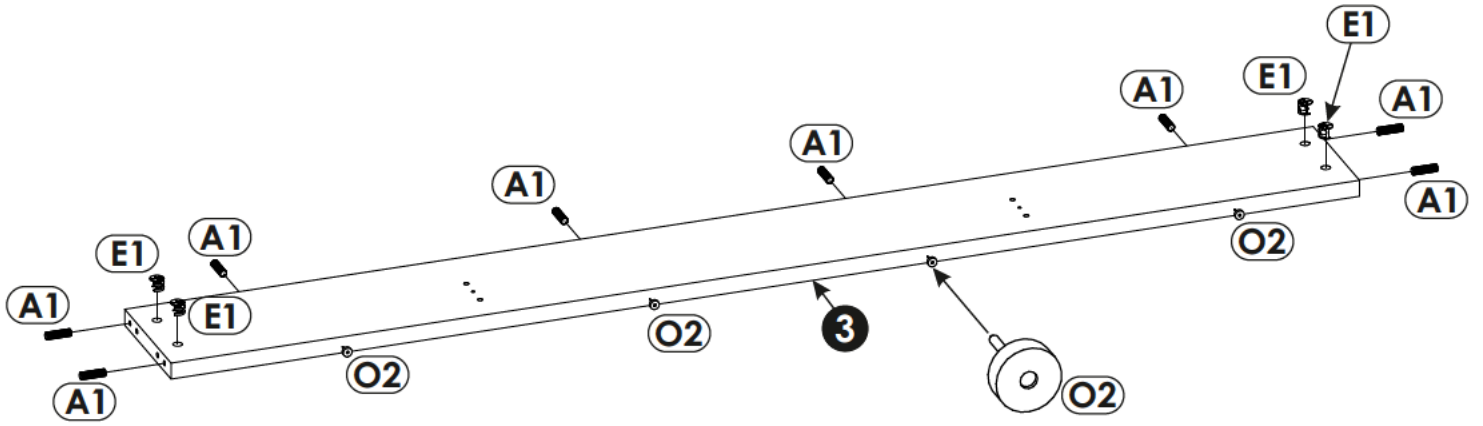

11▶

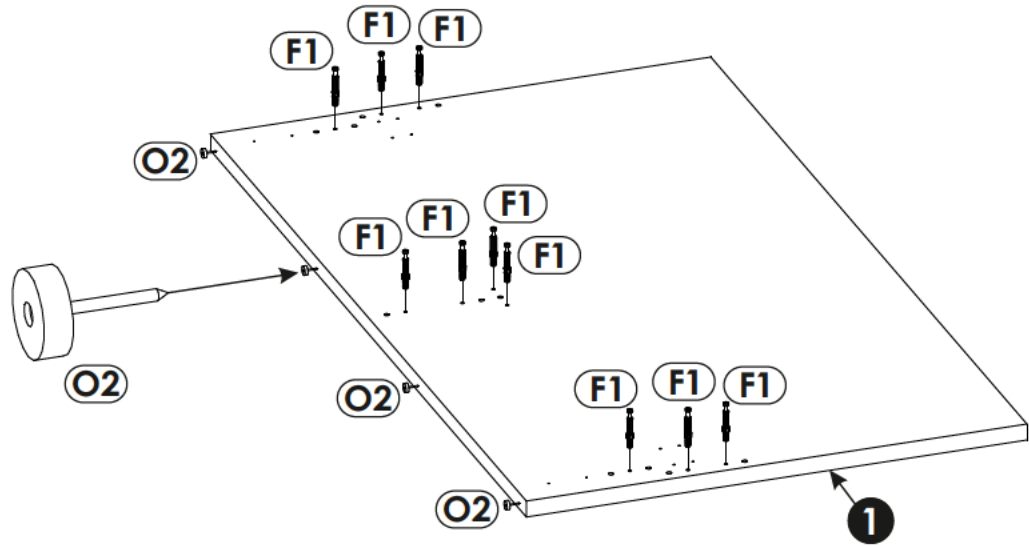
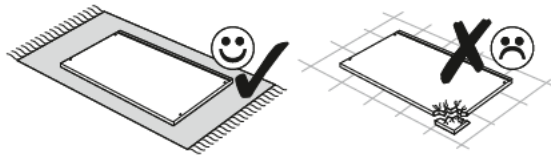

12▶

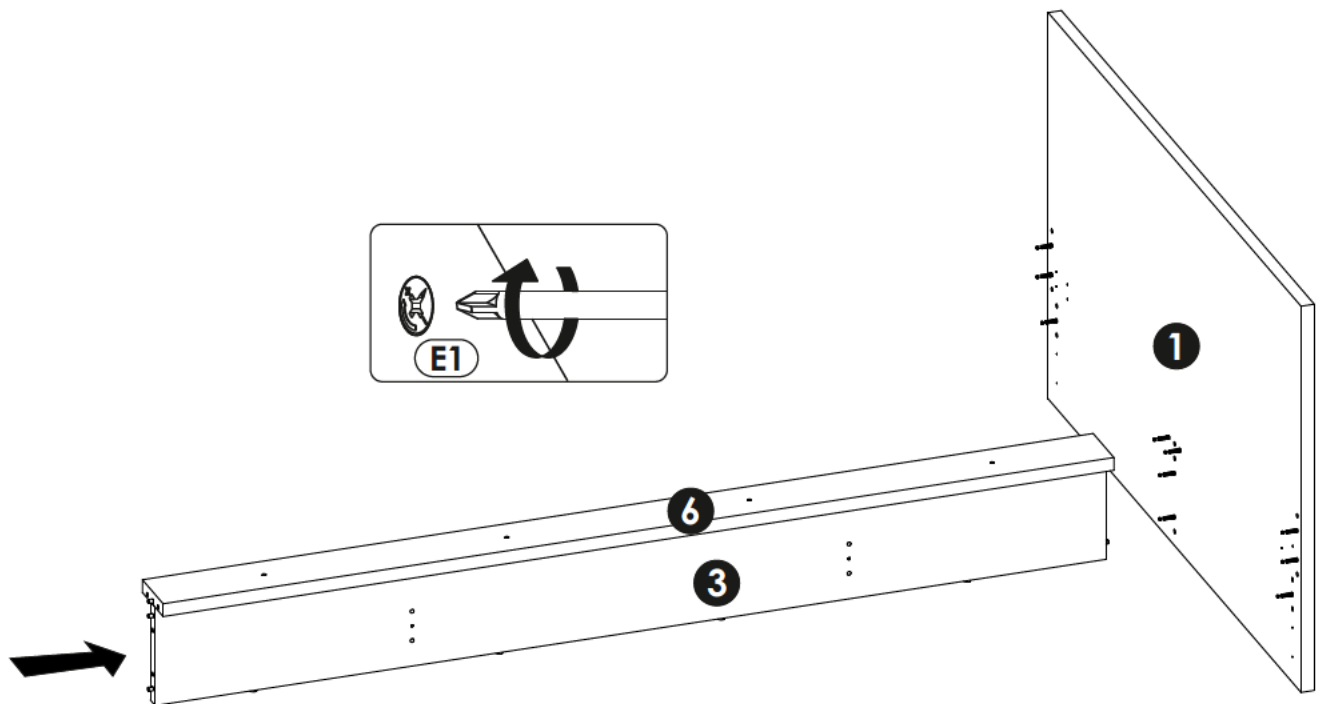
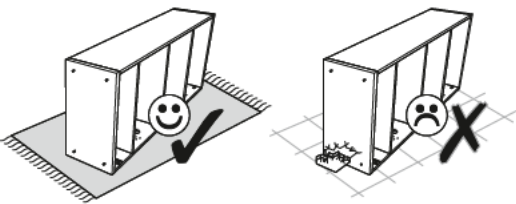

13▶

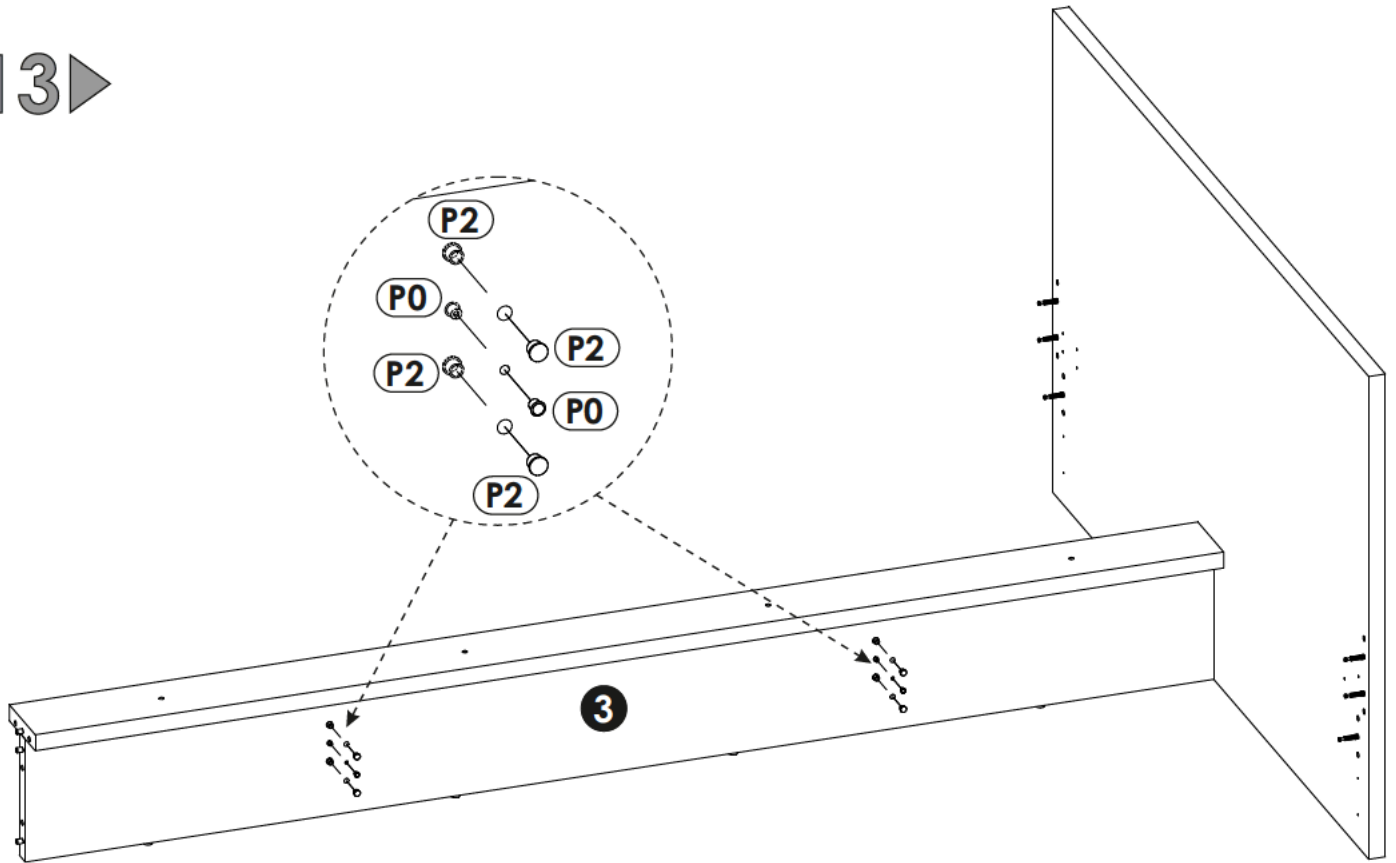

14▶

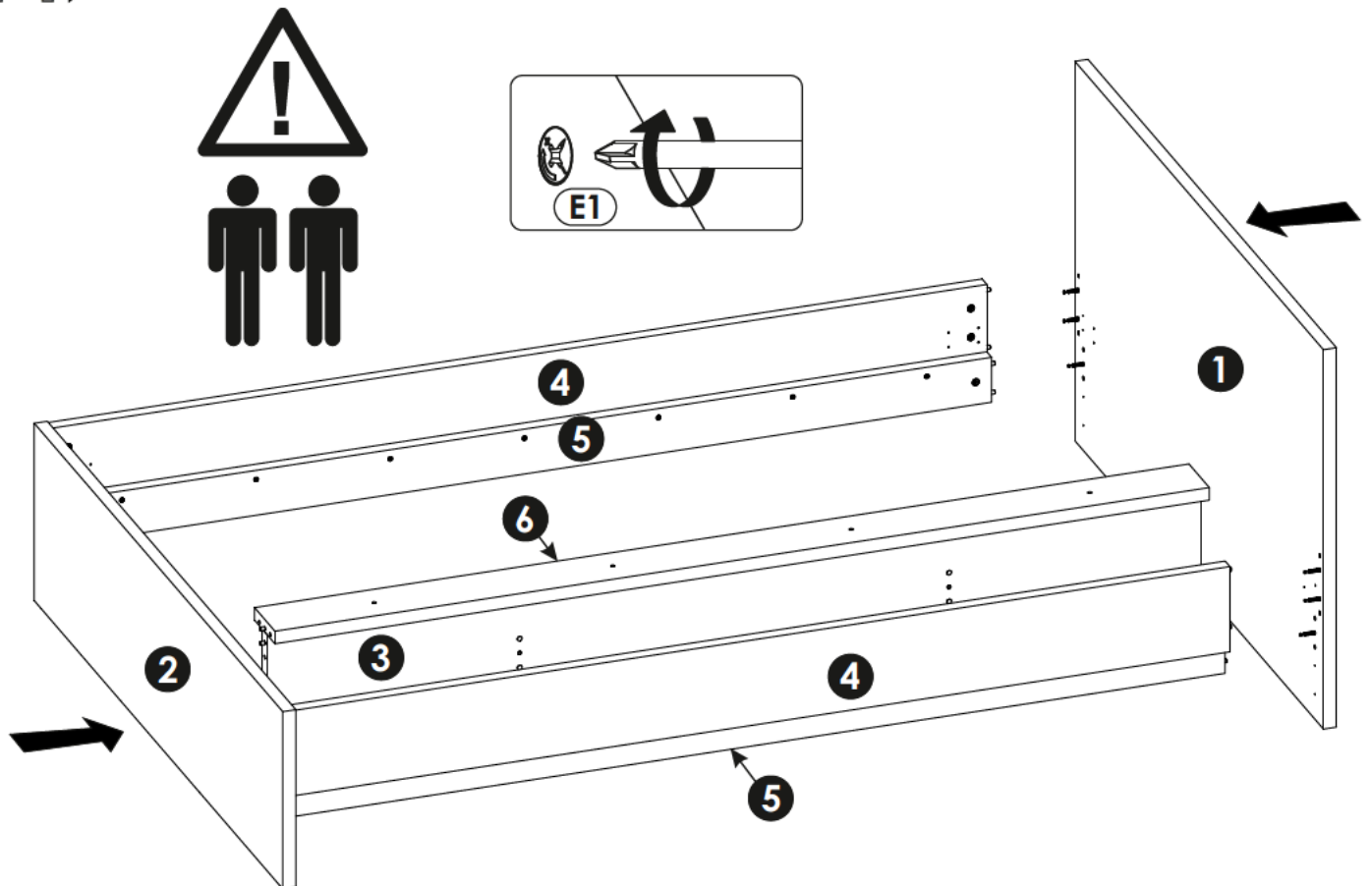

15▶

