

**MODEL: IG10600148C-1212-WLY**

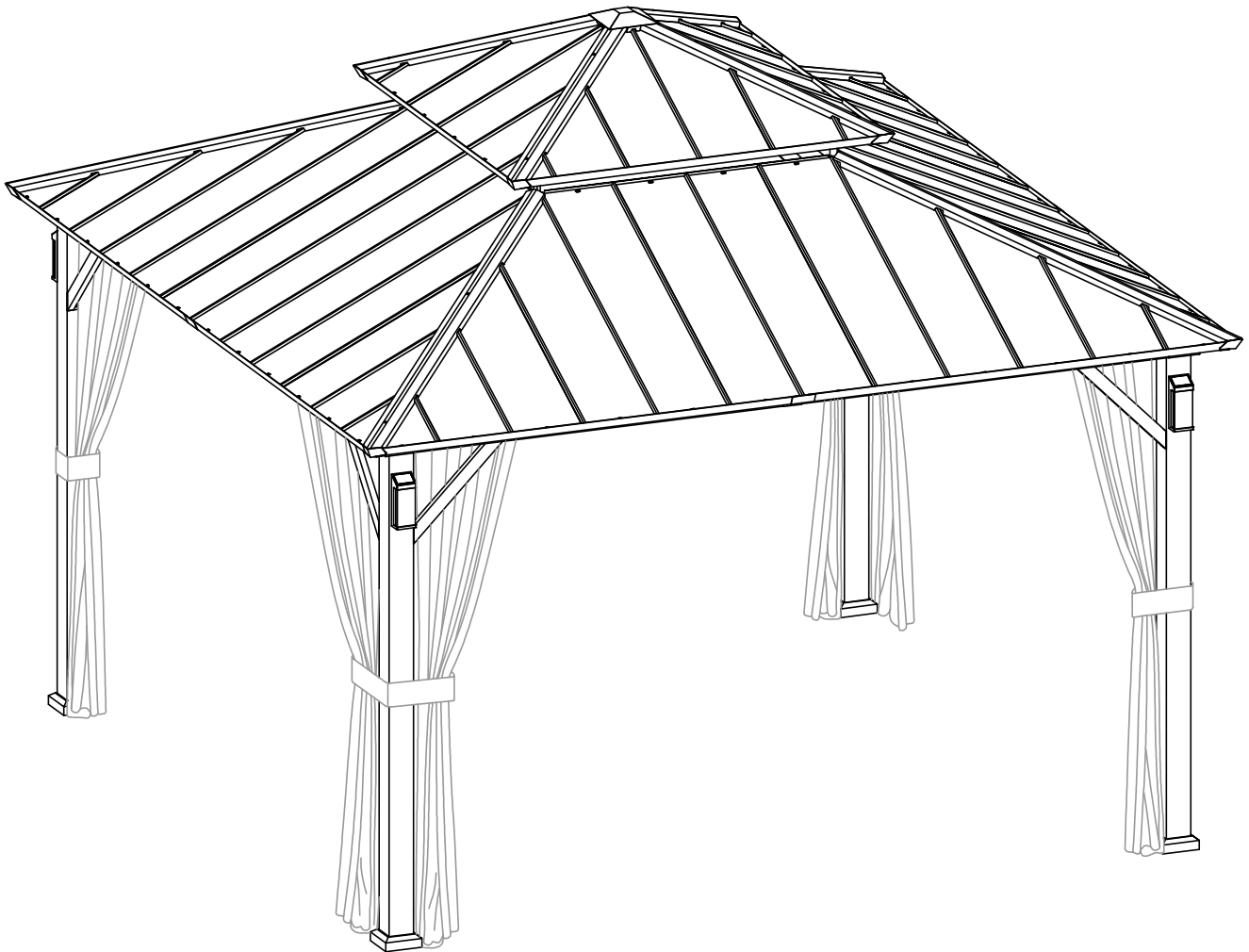

OWNER'S MANUAL

## The Horizon 12'x12' Hard Top Gazebo W/ Solar LED light

### TABLE OF CONTENTS

ASSEMBLY GUIDE.....	02
USING YOUR PRODUCT.....	04

March 27, 2025

### QUESTIONS?



E-mail: [support@modernshade.org](mailto:support@modernshade.org)











Toll Free: 1-888-666-3070

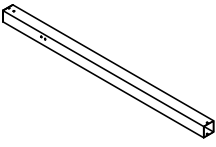
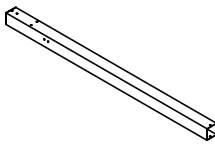
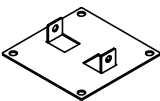
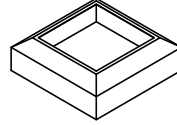
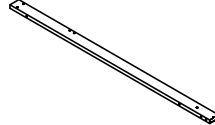
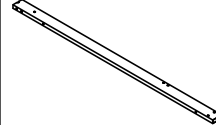

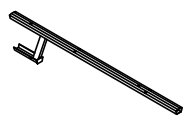
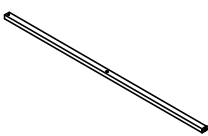
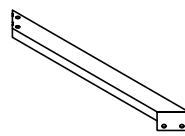
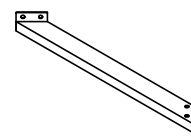
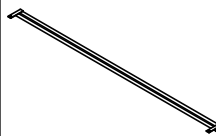
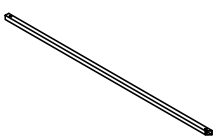
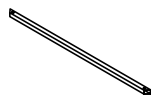
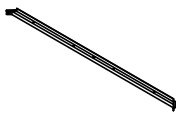
Mon-Fri: 9am---5pm PST.

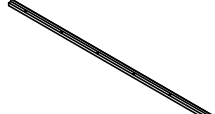
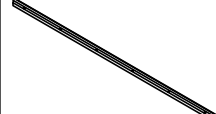
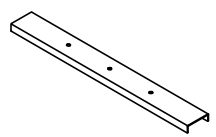
# ASSEMBLY GUIDE

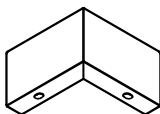
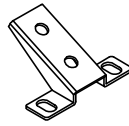
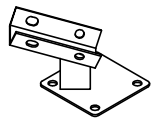
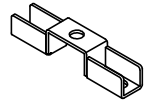
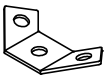
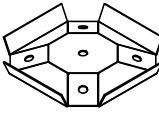
## PARTS LIST

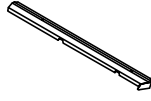
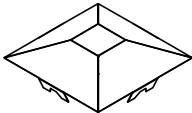
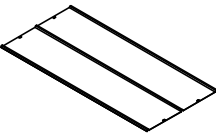
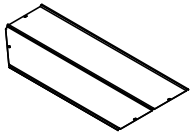
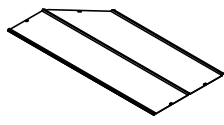
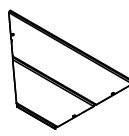
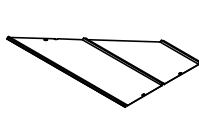
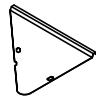
<b>A1</b> Post 1 (2 pieces) 	<b>A2</b> Post 2 (2 pieces) 	<b>B</b> Foot Base (4 pieces) 	<b>C</b> Foot Cover (4 pieces) 	<b>D4</b> Cross Beam 1 (4 pieces) 	<b>D5</b> Cross Beam 2 (4 pieces) 
P0010000302	P0010000402	P0030000201	P0020000201	P0040001302	P0040001402
<b>E1</b> Roof Rib 1 (4 pieces) 	<b>E2</b> Roof Rib 2 (4 pieces) 	<b>F1</b> Middle Cross Beam (4 pieces) 	<b>G1</b> Support Bracket 1 (4 pieces) 	<b>G2</b> Support Bracket 2 (4 pieces) 	<b>H3</b> Mosquito Net Rod (8 pieces) 
P0070000201	P0070000301	P0080000101	P0050000102	P0050000202	P0100000401
<b>J1</b> Top Beam 1 (8 pieces) 	<b>J5</b> Top Beam 2 (4 pieces) 	<b>K5</b> Roof Support 1 (4 pieces) 	<b>K9</b> Roof Support 2 (4 pieces) 	<b>K12</b> Roof Support 3 (4 pieces) 	<b>K13</b> Roof Support 4 (4 pieces) 
P0090000101	P0090000501	P0090001001	P0090001401	P0090001701	P0090001801
<b>L1</b> Connector 1 (4 pieces) 	<b>L2</b> Connector 2 (4 pieces) 	<b>L3</b> Connector 3 (4 pieces) 	<b>L4</b> Connector 4 (4 pieces) 	<b>L5</b> Connector 5 (4 pieces) 	<b>L6</b> Connector 6 (8 pieces) 
P0060000201	P0110000202	P0110000402	P0060000301	P0060000401	P0060000501
<b>L7</b> Connector 7 (16 pieces) 	<b>L8</b> Connector 8 (1 piece) 	<b>L9</b> Connector 9 (4 pieces) 	<b>M1</b> Roof Rib Cover 1 (4 pieces) 	<b>M2</b> Roof Rib Cover 2 (4 pieces) 	<b>M3</b> Roof Rib Cover 3 (1 piece) 
P0060000601	P0060001101	P0110000501	P0120000101	P0120000301	P0120000401
<b>N1</b> Roof Plate 1 (4 pieces) 	<b>N2</b> Roof Plate 2 (4 pieces) 	<b>N3</b> Roof Plate 3 (4 pieces) 	<b>N4</b> Roof Plate 4 (4 pieces) 	<b>N5</b> Roof Plate 5 (4 pieces) 	<b>N6</b> Roof Plate 6 (4 pieces) 
P0130000101	P0130000201	P0130000301	P0130000401	P0130000501	P0130000601

# ASSEMBLY INSTRUCTIONS

•Please carefully unpack each of the components and hardware. check the components against the parts list and make sure there are no missing parts. lay pieces on cardboard or a soft mat to help protect the pieces from scratches.

## ⚠ CAUTION

Watch for sharp edges when handling the pieces, wear gloves to avoid injury.

**STEP 01** Slide Foot Cover **C** onto Post 1 **A1**. Attach Foot Base **B** using two (2) M6\*20 Bolts **AA** and two (2) M6 Flat Washers **DD**. Repeat for the second Post 1 **A1**. Slide Foot Cover **C** onto Post 2 **A2**. Attach Foot Base **B** using two (2) M6\*20 Bolts **AA** and two (2) M6 Flat Washers **DD**. Repeat for the second Post 2 **A2**.

**AA** x 8  
**DD** x 8

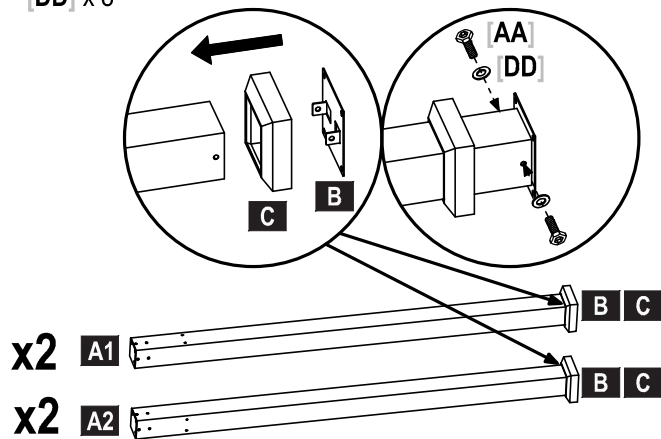

- For ease of assembly, it is recommended to have 3 or more people and allow enough time to completely finish the assembly. assembly can take 6-8 hours. a step-ladder is required for assembly (not included).
- Follow step by step instructions, and follow all safety warnings provided with your tools.
- DO NOT tighten screws until all the screws and washers are properly installed. Tighten screws securely, do not over tighten.
- Gazebo should not be used in inclement weather and high winds.

**STEP 02** Slide Cross Beam 1 **D4** and Cross Beam 2 **D5** onto the ends of one (1) Connector 1 **L1**. Secure with a Connector 2 **L2** using five (5) M6\*20 Bolts **AA** and five (5) M6 Flat Washers **DD**. Repeat to create four (4) assemblies.

**AA** x 20  
**DD** x 20

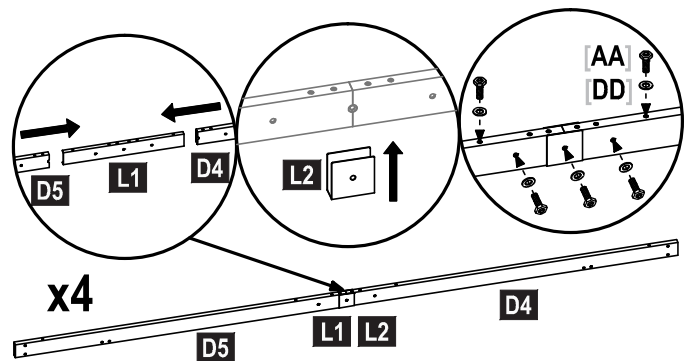

**STEP 03** Connect the assembly from Step 2 to Post 1 **A1** and Post 2 **A2** using four (4) M6\*20 Bolts **AA** and four (4) M6 Flat Washers **DD**. Repeat to create a second set of legs.

**AA** x 8  
**DD** x 8

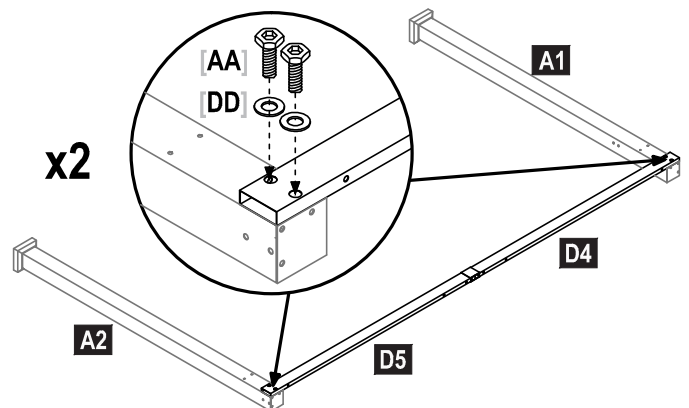

**STEP 04** Connect the sets of legs from Step 3 together using the remaining assemblies from Step 2 using eight (8) M6\*20 Bolts [AA] and eight (8) M6 Flat Washers [DD].

[AA] x 8

[DD] x 8

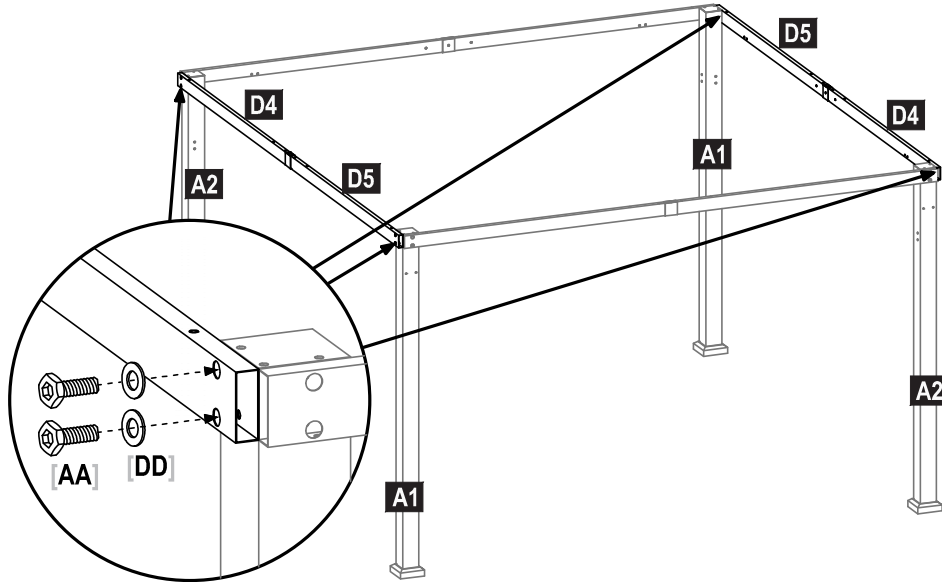

**STEP 05 CRITICAL: SQUARE UNIT BEFORE PROCEEDING TO NEXT STEPS.  
ONCE SQUARE, TIGHTEN ALL HARDWARE.**

