

# Owner Manual



Weight Limitation  
**100 LBS**



Installation:  
10 minutes.

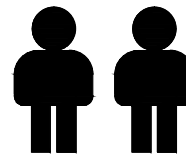

Two Person

Thank You For Choosing Our Furniture

- ▀ If you have any questions or concerns, don't hesitate to reach out to us. ▀

## NOTE:





This brochure contains **IMPORTANT** safety info. Please read and keep it for future reference.

# MAINTENANCE AND WARNINGS



## Before You Start

### *Please follow the steps below:*

-  Check the packaging for any damage, deformation, or water stains. If there is significant damage, please contact us promptly.
-  Unpack the box and compare the contents with the parts list and hardware list to ensure all components and accessories are present and complete.
-  Please read the installation instructions carefully to understand the installation steps and precautions to ensure proper installation.
-  Clean the installation area in advance and ensure the ground is level and there is enough space to avoid damaging the furniture or making installation difficult.
-  Lay a protective mat on the ground to prevent scratching the floor during installation.

### *After-Sales Service*

- If you encounter any issues or need technical support during use, please contact our after-sales team. We offer long-term maintenance and warranty services.



## Precautions

- ⚠ This product is for indoor use only. Do not expose it to outdoor elements or high-humidity environments.
- ⚠ Keep the product away from high heat or open flames to prevent fire hazards.
- ⚠ Do not allow children to climb on the product, as this may cause tipping and result in personal injury.



## Safety Warnings

- ⚠ If you notice any loose or damaged parts, stop using the product immediately and contact customer service.
- ⚠ Do not attempt to disassemble or replace any components yourself, as this may affect the stability and safety of the product.

### ***Daily Maintenance***

- Regularly clean the surface with a soft cloth to prevent dust accumulation.
- Do not use cleaning agents containing acids, alkalis, or corrosive substances, as they may damage the surface. It is recommended to use neutral cleaning agents or specialized furniture cleaners.
- Avoid exposing furniture to humid environments for extended periods. Use a dehumidifier or desiccant during humid weather.
- Avoid direct contact of furniture with water. If water is accidentally spilled, wipe it dry immediately.
- Avoid placing excessively heavy objects on the furniture: ensure the weight is within a reasonable load-bearing range.
- Avoid using sharp or rough items on the furniture surface to prevent scratches. Handle items gently when moving them.

***Explosive view***

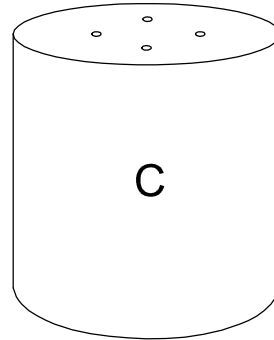
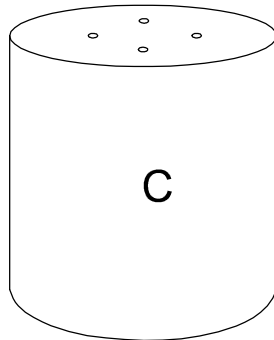
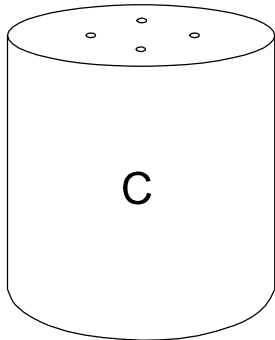
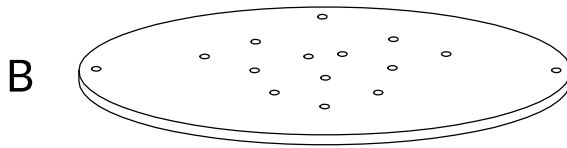
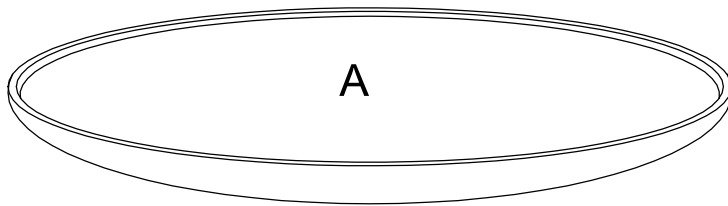
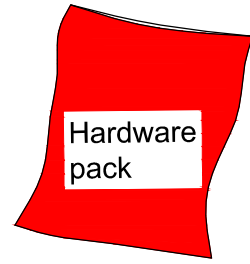

## Parts list

### Box A

A x1



### Box B

B x1

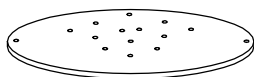

C x3

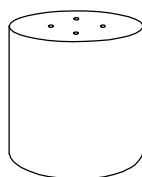

## Hardware List

①x15+3

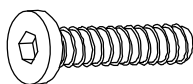

6x25mm

②x15+3



6x20mm

③x1

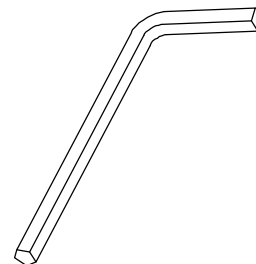



M6

# Step 1

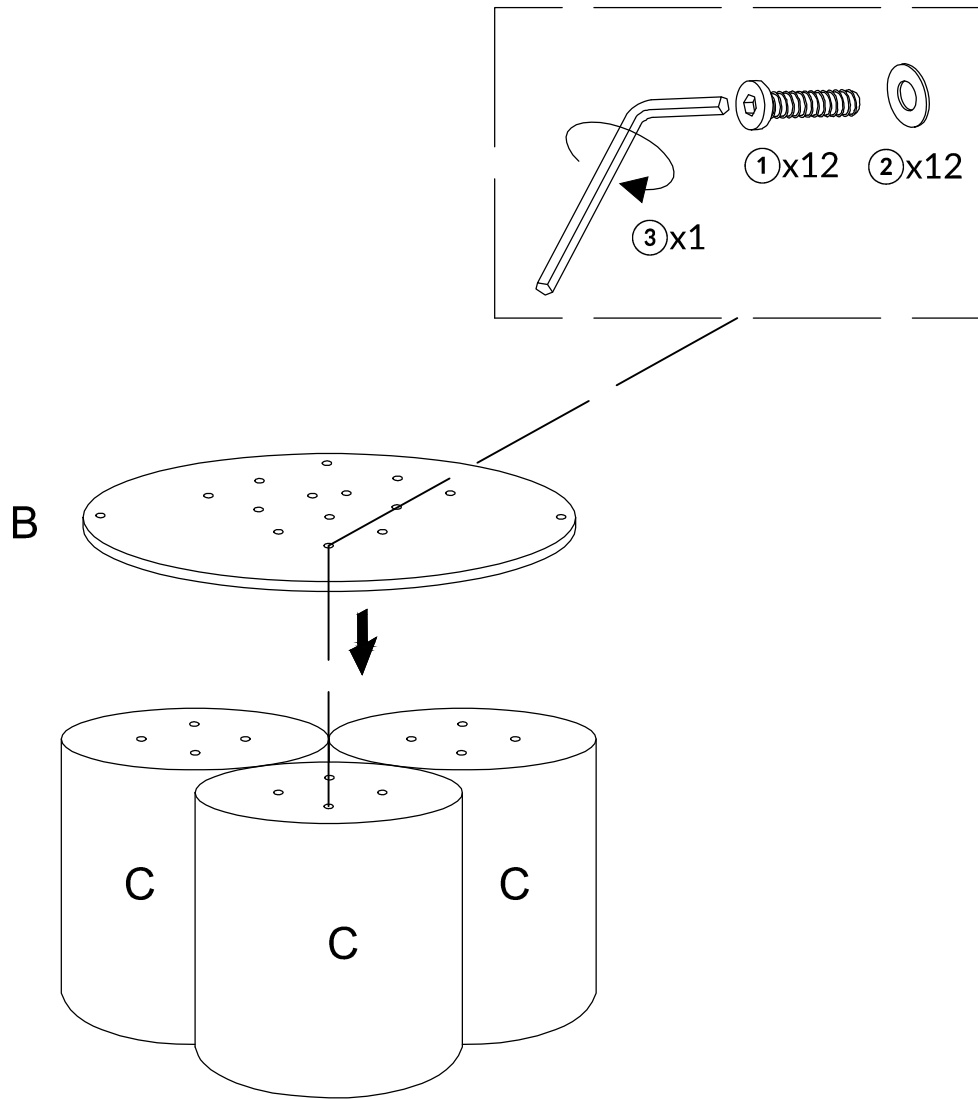
Install Side C and B, then tighten with wrench ③.



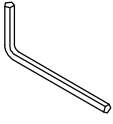

①x12	②x12	③x1
		
6x25mm	6x20mm	M6

## Step 2

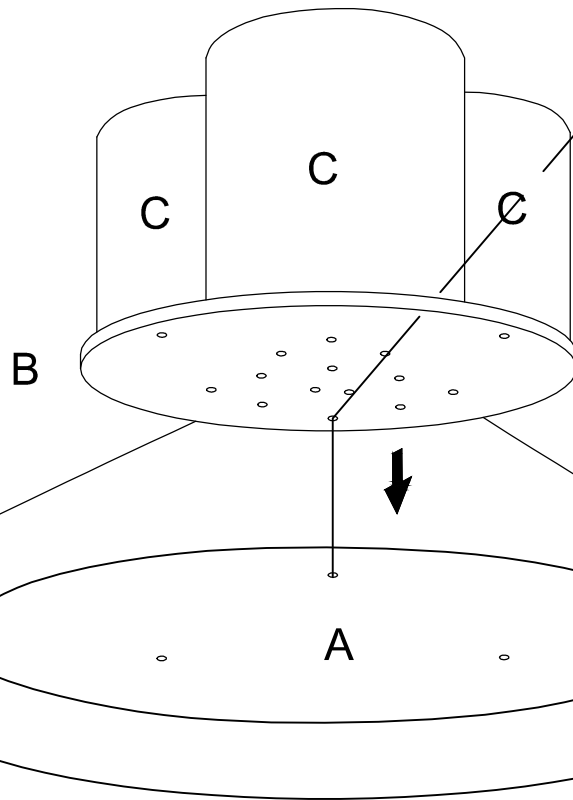
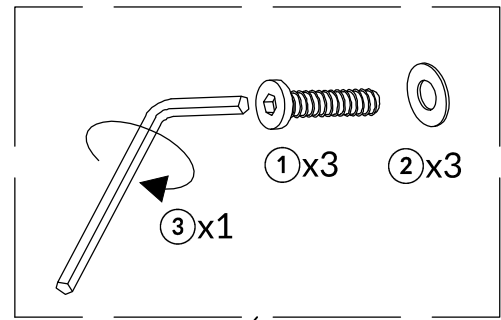
Install Side A and B, then tighten with wrench ③.



①x3	②x3	③x1
		
6x25mm	6x20mm	M6

# WARRANTY

- We strive to offer quality products, and we also try our best to satisfy every customer who orders from us with products or services as needed.
- Replacement parts can be purchased from our company if available.
- For returns, please check the return policy with the retailer or marketplace where you purchased the item.

We appreciate your purchase.  
Brighten your life with our furniture!