







# BENCH ASSEMBLY INSTRUCTIONS

## Assembly Instruction & Care:

Please assemble on a soft surface after removing contents as not to scratch or damage stone surface.  
 Also, take caution with finger prints and dirt during assembly.  
 Wash with soft cloth and mild detergent like Dawn or Palmolive diluted with warm water. Scrub gently.  
 Enjoy!

| Item | Description  | Q'ty |
|------|--|------|
| A    |  Bolt 8x80      | 02   |
| B    |  Bolt M8x50     | 04   |
| C    |  Flat Washer M8 | 04   |
| D    |  Washer         | 02   |
| E    |  Nut M8         | 02   |
| F    |  Allen Key      | 01   |
| G    |  Wrench         | 01   |

**STEP 1**

- Assemble two bench base legs with crossbar.
- Attach (2) "A" Bolts, (2) "D" Washers, (2) "E" Nuts.

**CAUTION: Insert "A" Bolts by hand and turn until they stop turning approx one-third to half way.**

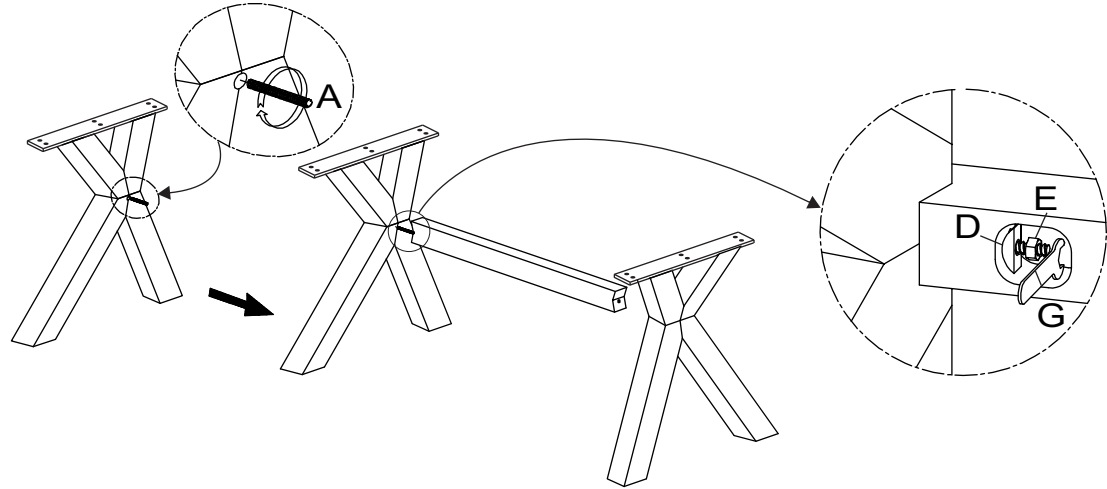

Bench Top

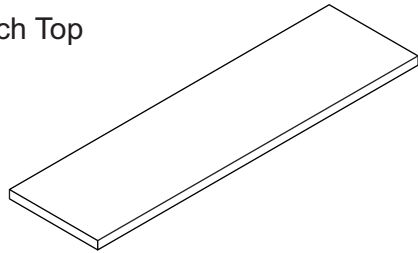

Bench Base(2pcs)

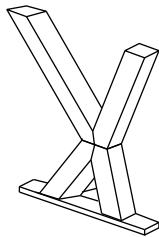

Crossbar

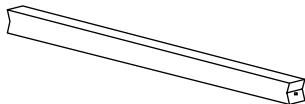

**STEP 2**

- Place Bench top on a soft surface upside down as shown.
- Fasten (4) "B" Bolts and (4) "C" Flat washers to table top underside and frame.

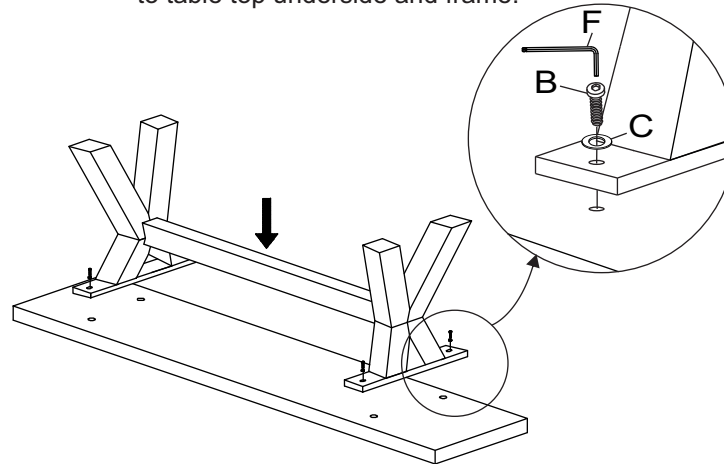

**STEP 3**

- With 2 people carefully stand Bench upright.

