

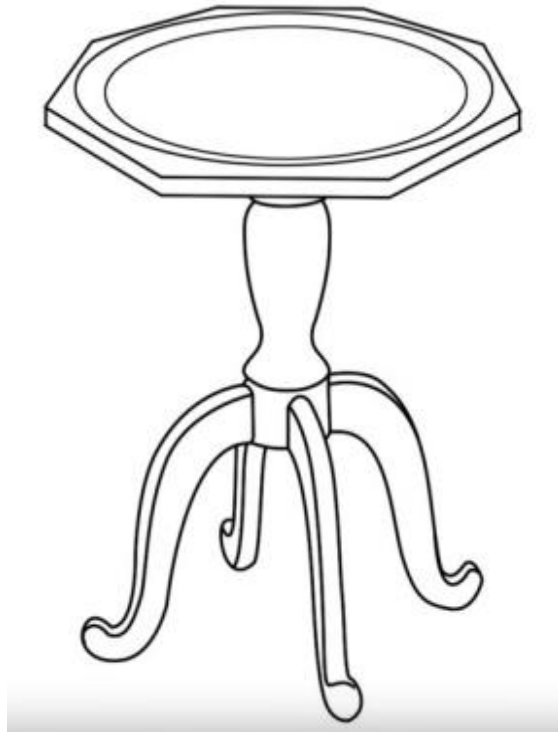



Assembly Instructions

Caution : You must read this before you proceed

End Table









Parts List

Label	Picture	Description	QTY
A		Table Top	1
B		Leg	1
C		Feet	4

D		Wood block	1
---	-----------------------------------------------------------------------------------	------------	---

Hardware

Label	Picture	Description	QTY
①		Bolt(M6*25MM)	5
②		Bolt(M8*25MM)	2
③		Flat Washer(M6)	5
④		Flat Washer(M8)	2
⑤		Adjustable Leveller	5
⑥		Allen Key(M6)	1
⑦		Allen Key(M8)	1

Assembly Preparation

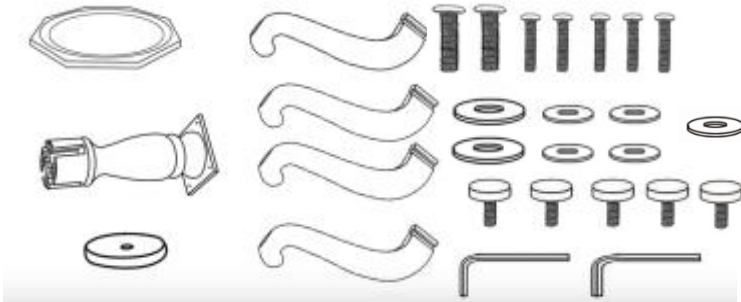
Before Beginning Assembly :	
-----------------------------	--------------------------------------------------------------------------------------



- Read instructions, cover to cover-



- Have 2 adults on hand for assembly-



- Do not assemble on flooring or carpet-



- Assemble on a clean non-marring surface (packing foam)-



- Save all packaging until finished-

Assembly Steps

Overview

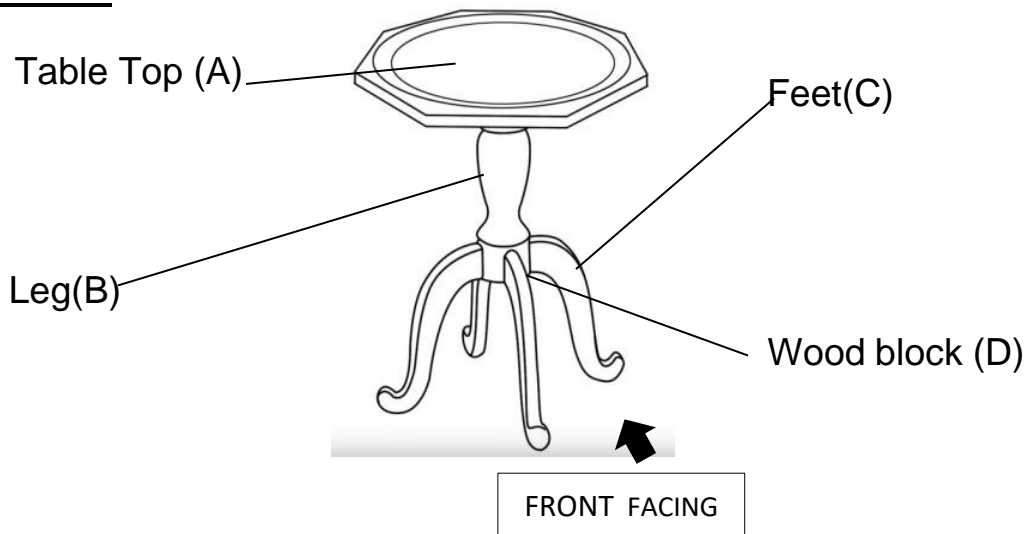

This End Table has multiple parts and may require up to some 30 minutes to assemble.

To give you an overview of the End Table parts, the above picture is to help you put the various parts into perspective.

Please read through the instructions herebelow to familiarise the parts and steps before assembly.

Step 1

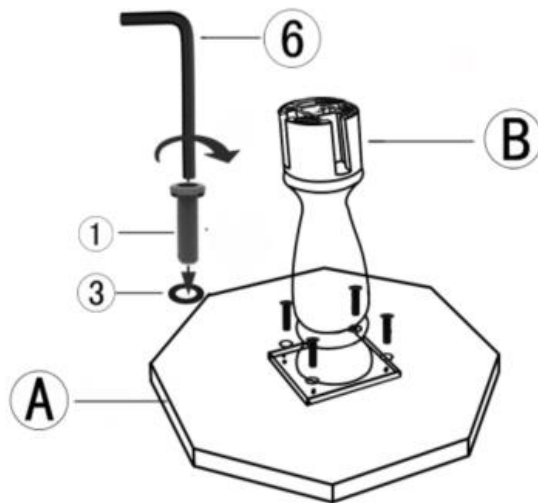

Place the Table Top(A) on a clean, non-marring surface, facedown.
Attach Leg(B) to the Table Top(A) using Bolt(1) and Flat Washer(3) with Allen Key(6).

Step 2

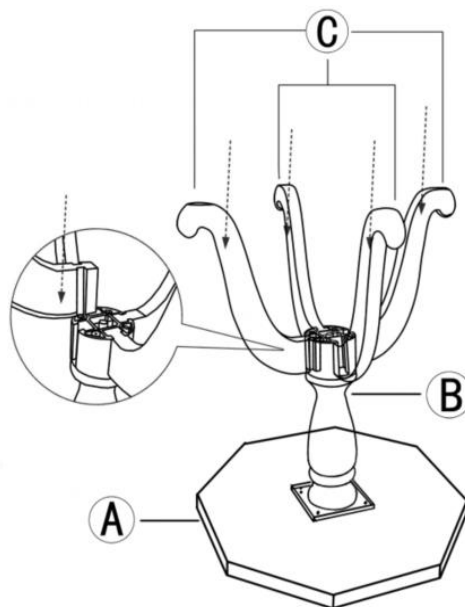

Insert Feet(C) to the Les(B), repeat the same step to insert the remaining 3 legs.

Step 3

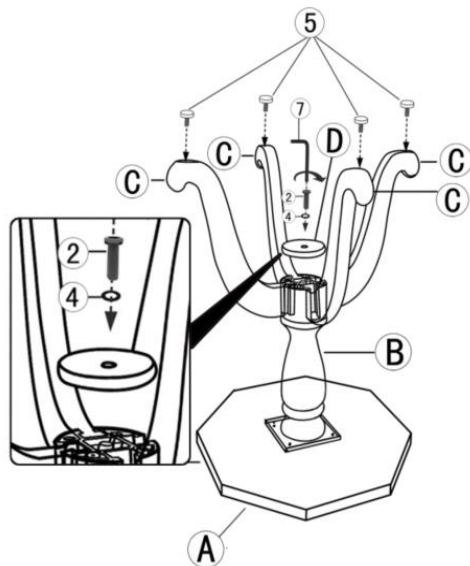

Attach Wood block(D)to the Leg(B) using Bolt(②) and Flat Washer(④) with Allen Key(⑦). Then attach Adjustable Leveller(⑤) to the Feet(C) by hand.

Step 4

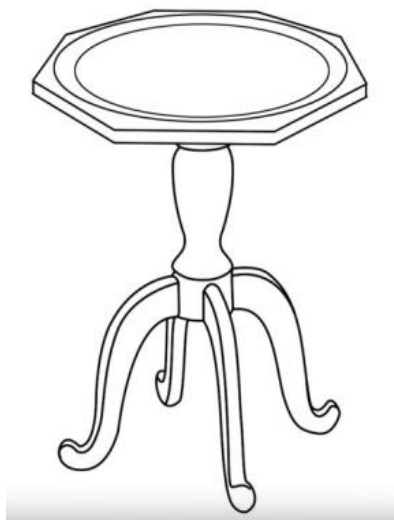

Turn the End Table right side up.
Your End Table is ready for use.
Caution: This End Table can only be used on a flat, level surface.

Care & Maintenance



- Furniture may scratch floors. We recommend using furniture pads to protect your floors.



- Do not put hot items directly on furniture surface.



- Do not clean furniture with harsh cleansers or polish.



- Do not place furniture under direct sunlight.



- Do not place furniture near heating or cooling vents.



- Do not write on furniture without a padded barrier to protect the surface.



- Do not place furniture outside . For indoor use only.



- Not for commercial use. For residential use only.



- Stains may be removed with mild soap solution and damp cloth.



- Children should not climb or jump on the furniture.



- Dust and pick-up spills using a clean, non-colored, lint-free cloth.