

# Installation Instructions

## HT3322S-9-S

## Dual Mount Stainless Steel Sinks

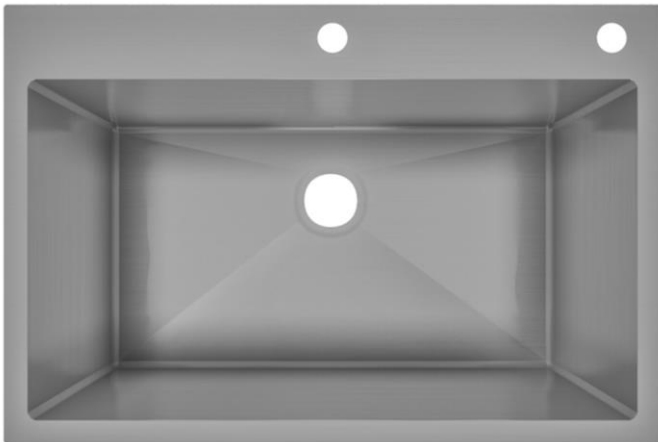

### Tools You Will Need

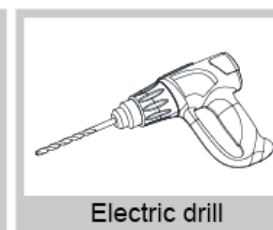
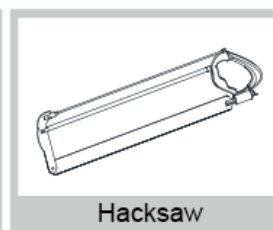
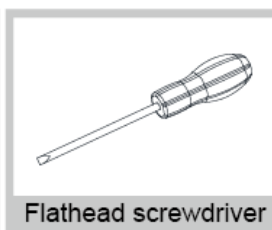
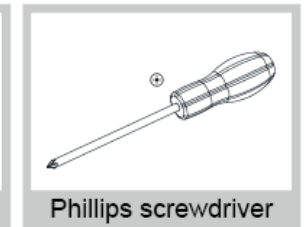
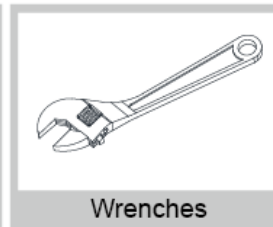
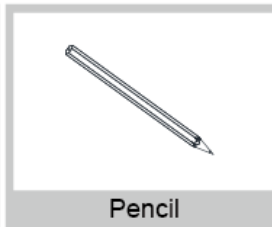
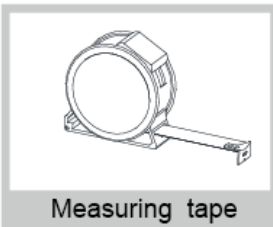

### INSTALLATION TIPS

- For optimum installation results homeowners, cabinet makers, countertops, and sink installers should all be involved in the planning and installation process.
- The manufacturer suggests this sink be installed by a locally licensed professional and recommends using the actual sink to determine the final cabinet and countertop dimensions.
- Prior to installation be sure to inspect the sink for damage. The manufacturer is not responsible for damage caused during installation or by improper installation.
- Be sure to use proper tools and always wear personal protective equipment for your safety.
- Caution: Metal edges may be sharp – handle with care.



# Dual Mount Stainless Steel Sinks

## Installation / Installation / Instalación

Sinber dual mount stainless steel handmade sink, which can either be installed above the countertop or installed under the countertop. It is recommended that all countertops be cut by an approved or certified installer and the sinks be installed by the installer whenever possible. The countertop/sink unit ideally should be installed as one on the job site.

**Step 1** – Remove your new sink from the carton. Use caution as sink edges may cause minor cuts. Wear safety gloves for your protection.

**Step 2** – If you are replacing an old sink, remove the old one and verify existing countertop opening will fit your new sink by setting it temporarily.

**Step 3** – If you are installing a sink to a new countertop, please follow directions as shown, and choose top mount installation or under-mount installation cut outlines accordingly

**Step 4** – Place the paper template on the countertop in the desired position, tape the template in place, and trace completely outside the line using a soft lead pencil. (Figure 1).

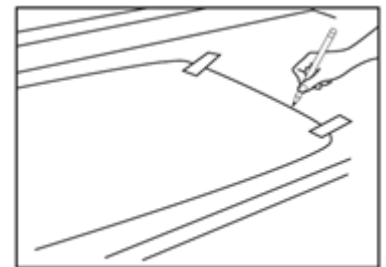

Figure 1

**\*\*Templates are supplied as a guide. We recommend using the actual sink for the most accurate cut.\*\***

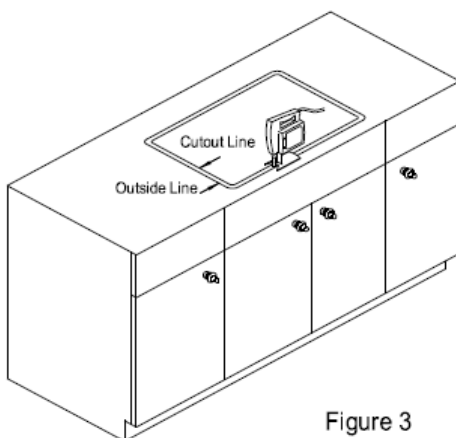

Figure 3

**Step 5** – Drill a hole at the inside corner of the cutout lines.

**Step 6** – Using a jigsaw, start cutting from the drilled hole along the cutout line. (Figure 3)

**Step 7** – Apply caulking compound around the perimeter of the cutout opening.

**Step 8** – Attach the faucet and strainer as necessary according to the manufacturer's instructions. (Verify your sink installation channel and clips that come with the sink and follow proper instructions, STEP 9 is only followed when this sink is installed as top-mount style, if this sink is installed as under-mount style, please proceed to STEP 11 directly.)



# Dual Mount Stainless Steel Sinks

## Installation / Installation / Instalación

**Step 9** – Place the sink into the cutout opening and be sure it is properly seated, make sure the sink rim covers caulking all around. Insert the clips into the U shape channels at the backside of the sink rim. (recommended clip placement, two clips on each rim, Figure 4)

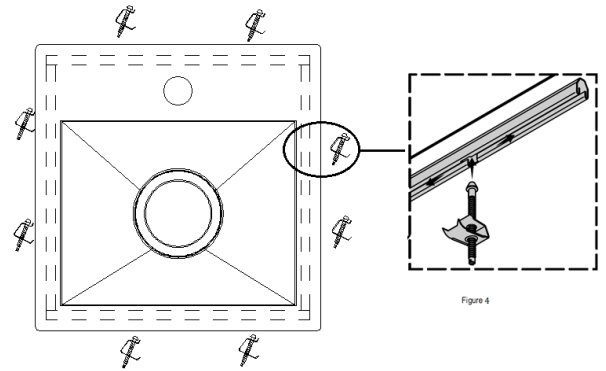

Figure 4

**Step 10** – Rotate the clip, tighten to secure sink, and do not over tighten as damage can result. (Figure 5)

**Step 11** – Take out fastener, screws, and plastic nuts, for under-mount installation. Drill a hole from the backside of the countertop, and put the plastic nut in it for connecting screws. Attach the iron fastener with screws, make sure one end of the fastener holds the sink rim, while another end touches the backside of the countertop. (Figure 6)

**Step 12** – Install drain and water supply fittings as necessary. and Run water into the sink and check for leaks.

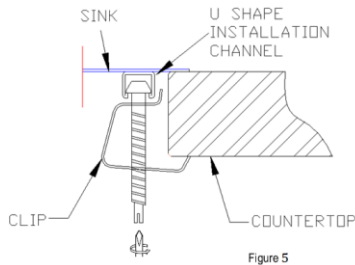

Figure 5

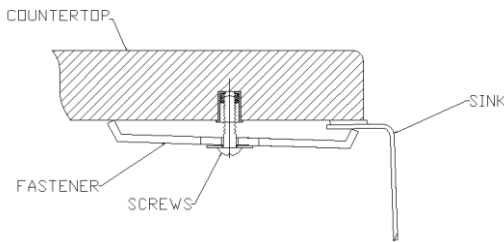

Figure 6



## Installation / Installation / Instalación

### Care & Cleaning Guidelines

#### Cleaning

- Daily, regular cleaning to remove dirt and prevent staining is recommended. Use liquid dish detergent, water, and a soft household sponge.
- Mild, non-abrasive cleaners can be used with a nylon scrub pad. To ensure a uniform appearance on a stainless steel sink surface, rinse with water and wipe down the sink with a soft, dry cloth. Drying the sink will prevent water spots caused by time in the water.
- Remove stubborn stains from lime or calcium deposits by pouring a little warm vinegar or vinegar-based cleaner into the sink and allowing it to sit for a few minutes. Rinse with clean water and dry.

Please note chlorides are found in almost all soap, detergents, bleaches, and cleansers. Chlorides can be harsh on stainless steel. Rinse your sink thoroughly after each use to remove any chloride residue.

#### Scratches

Scratches are inevitable during your usage over time. To treat, use a nylon pad with an iron-free abrasive polishing compound. Follow the original polish lines to blend out the scratch in a small area. Be cautious not to overdo the process, as cleaning too aggressively could result in a bright spot.

#### Rust Spots

Stainless steel does not rust. Rust stains are the result of iron particles introduced by water, cookware, and steel wool pads that react with water to create rust. Metal cleaners will remove rust spots.

#### Food Stains

Depending on the severity of the stain, use a bleach and water solution or pour the bleach onto a cloth and cover the stain. Allow the bleach to sit for at least 1/2 hour and then clean with dish detergent and water.

#### Some Don'ts

- DO NOT use strong abrasive cleaners, metal scrub pads, or steel wool. These will scratch the surface.
- DO NOT leave rubber mats or sponges inside the sink. Water trapped below could lead to stains.
- DO NOT let food with a high salt content sit inside the sink for prolonged periods.
- DO NOT allow chlorine bleach to sit inside a stainless steel sink for more than 1 hour.
- DO NOT allow drain cleaners to come into contact with the sink surface.
- DO NOT pour paint into your sink. The chemicals in acrylic paint will react with sinks if allowed to sit over 24 hours and will produce permanent marks. For latex-based paints, remove any residue immediately using a paint remover manufactured by the same brand. Consult the paint remover recommendations before using it on the sink. For all sinks, we also recommend nail polish remover, rubbing alcohol, or an acetone-based paint remover to eliminate paint residue.

