

# ASSEMBLY INSTRUCTION

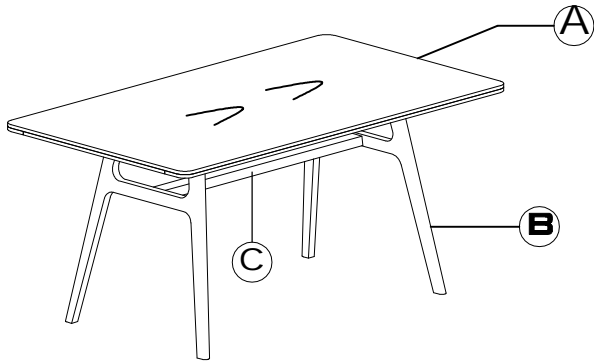







## dining table



### Part Check - List

code	component	qty.
(a)	Table top	X1
(B)	LEGS	X2
(C)	center rail	X1

### Fitting Check - List

CODE	COMPONENT	Q'TY
01	FULL TREAD 	X6
02	HEX NUT 	X6
03	JCBC 	X4
04	SPRING WASHER 	X10
05	FLAT WASHER Ø14 	X6
06	FLAT WASHER Ø18 	X4
07	D-WASHER 	X6
08	SPANNER M10 	X1
09	ALLEN KEY 	X1

- Please do not discard any of the packing until you have checked all the part the of fitting.
- Before you begin to assembly your new piece of furniture, please check to ensure that all have been supplied.
- Follow instruction closely as deviation from may void your warranty and present a possible safety risk .
- It is recommended that assembly is done on a soft surface like carpet to avoid any damage.
- Periodically check and re-tighten any fasteners . Wipe down all surface weekly with a clean cloth . Do not clean any surface with harsh abrasives or chemicals.

