

ASSEMBLY INSTRUCTIONS

NOTICE

IMPORTANT, RETAIN FOR FUTURE REFERENCE: READ CAREFULLY
WICHTIG, FÜR SPÄTERE NACHSCHLAGE AUFBEWAHREN: SORGFÄLTIG LESEN
IMPORTANTE, GUARDAR PARA REFERENCIA FUTURA: LEER ATENTAMENTE
IMPORTANTE, CONSERVARE PER RIFERIMENTI FUTURI: LEGGERE ATTENTAMENTE
IMPORTANT, À CONSERVER POUR RÉFÉRENCE FUTURE : LIRE ATTENTIVEMENT

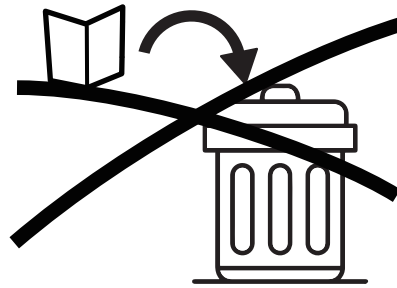
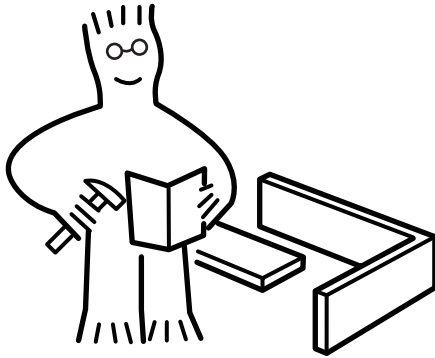

Assemble on a flat, clean and soft surface.
Auf einer flachen, sauberen und weichen Oberfläche zusammenbauen.
Assembler sur une surface plate, propre et douce.
Assemblare su una superficie piatta, pulita e morbida.
Ensamblar sobre una superficie plana, limpia y suave.

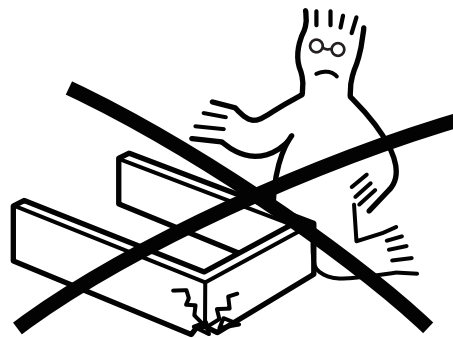
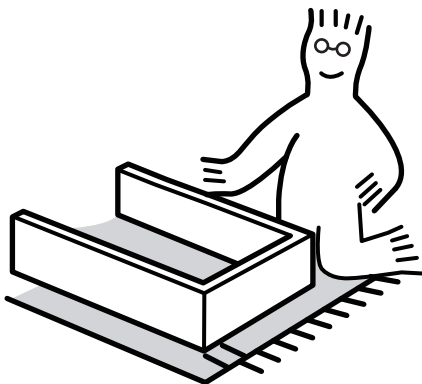

Professional installation is highly recommended.
Eine professionelle Installation wird dringend empfohlen.
Une installation professionnelle est fortement recommandée.
Si raccomanda vivamente l'installazione professionale.
Se recomienda altamente la instalación profesional.



Periodically Check That All Components Are Tightly Secured.
Überprüfen Sie Regelmäßig, Dass Alle Komponenten Fest Gesichert Sind.
Vérifiez Périodiquement Que Tous Les Composants Sont Bien Fixés.
Controllare Periodicamente Che Tutti I Componenti Siano Ben Fissati.
Verifique Periódicamente Que Todos Los Componentes Estén Bien Asegurados.

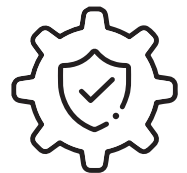

It is recommended that multiple people assemble this product.

Es wird empfohlen, dass mehrere Personen dieses Produkt zusammenbauen.

Il est recommandé que plusieurs personnes assemblent ce produit.

Si raccomanda che più persone assemblino questo prodotto.

Se recomienda que varias personas ensamblen este producto.

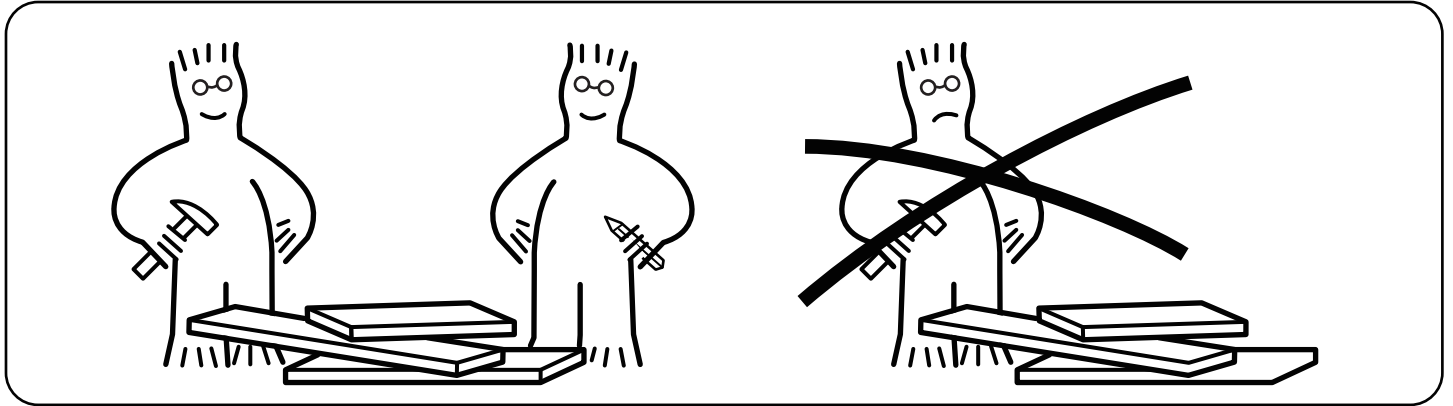

Please have the following auxiliary tools ready:

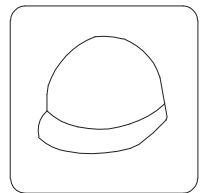
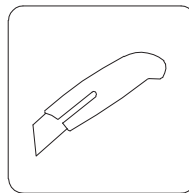
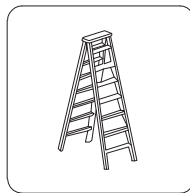
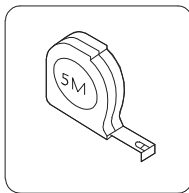
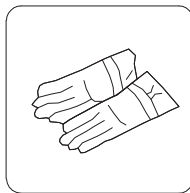
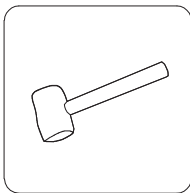
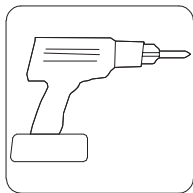



1. Confirm all parts are present prior to assembly
2. Assemble on a flat, clean and soft surface.
3. Do not fully tighten screws until all parts are assembled.







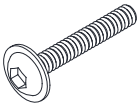
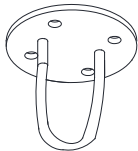

WARNING:

Thank you for purchasing. Please read below before you proceed.

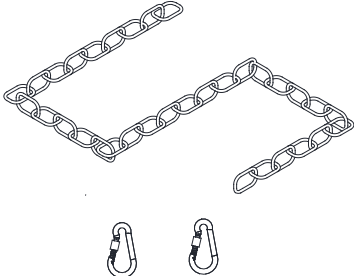
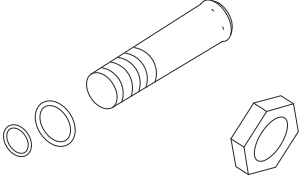
1. Not intended for use by children 12 years of age or younger.
2. This is a hanging chair, not a swing chair.
3. The hanging chair should be installed no more than 20" above ground.
4. The hanging chair should be installed at a minimum of 4-5 feet away from the walls.
5. The hanging chair should have a minimum clearance of 30" from any obstacles.
6. Do not swing on or in the chair. It could cause the product to tip over, resulting in possible injury.
7. This chair basket is not a toy.
8. Professional installation required

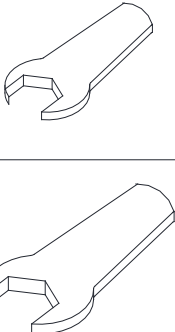
PARTS

| Item no. Nr. N° d'article Articolo No. Artículo No. | Reference Image Referenzbild Image de référence Immagine di riferimento Imagen de referencia | Qty. Menge Qté. Qtà Cant. | Item no. Nr. N° d'article Articolo No. Artículo No. | Reference Image Referenzbild Image de référence Immagine di riferimento Imagen de referencia | Qty. Menge Qté. Qtà Cant. |
|---|--|---------------------------------------|---|---|---------------------------------------|
| A |  <p>M6 X 35MM</p> | X3 | D |  | X1 |
| B |  | X3 | E |  | X1 |
| C |  | X4 | - |  <p>M6</p>  | X1 |

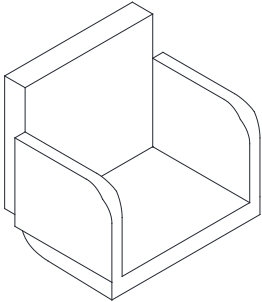
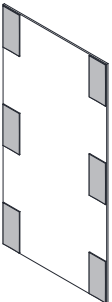
| Item no. Nr. N° d'article Articolo No. Artículo No. | Reference Image Referenzbild Image de référence Immagine di riferimento Imagen de referencia | Qty. Menge Qté. Qtà Cant. | Item no. Nr. N° d'article Articolo No. Artículo No. | Reference Image Referenzbild Image de référence Immagine di riferimento Imagen de referencia | Qty. Menge Qté. Qtà Cant. |
|---|--|---------------------------------------|---|--|---------------------------------------|
| 1 |  | X1 | | | |
| 2 |  | X1 | | | |
| 3 |  | X2 | | | |

ASSEMBLY

1



①x1

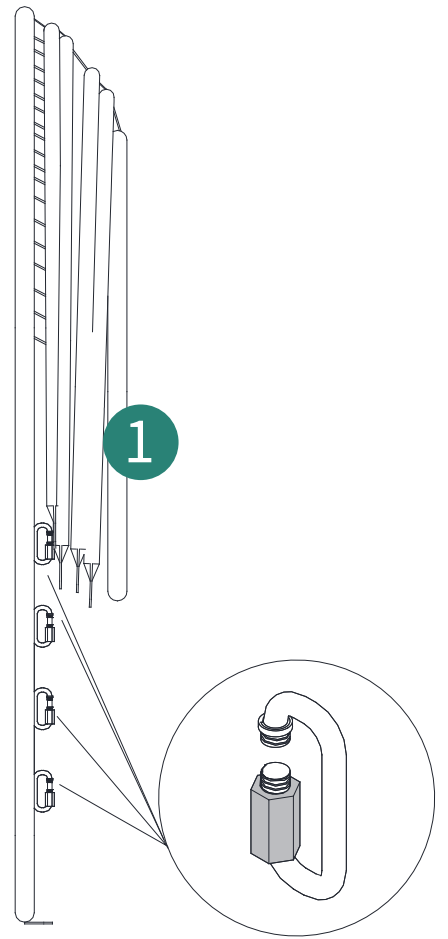
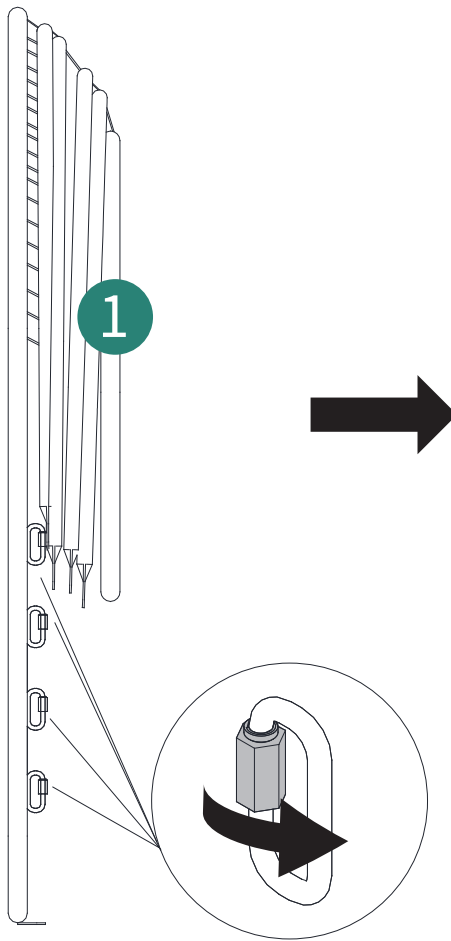

Use a wrench to loosen eight buckle nuts

2

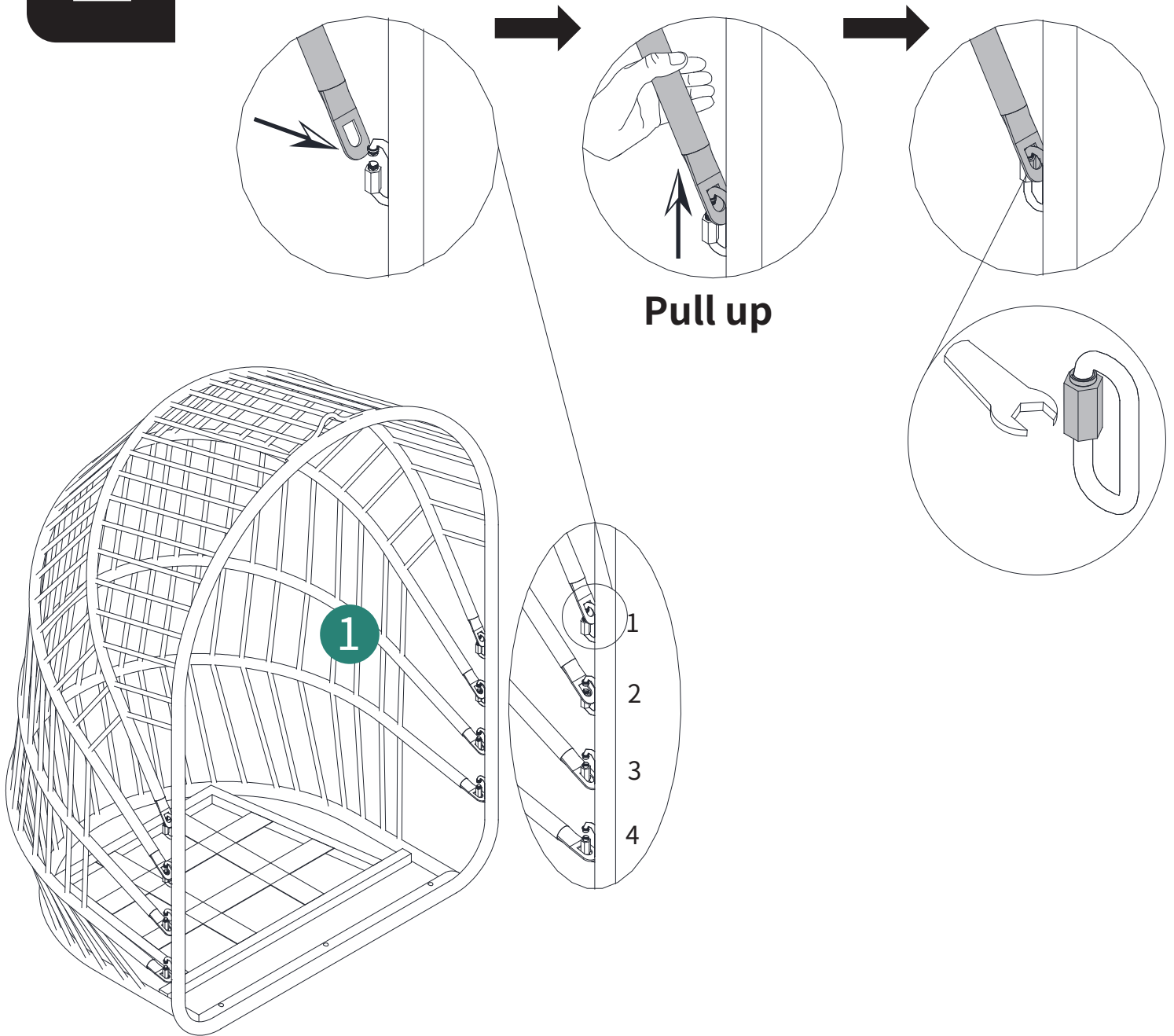

The second nut can be installed only after the first nut is tightened

3

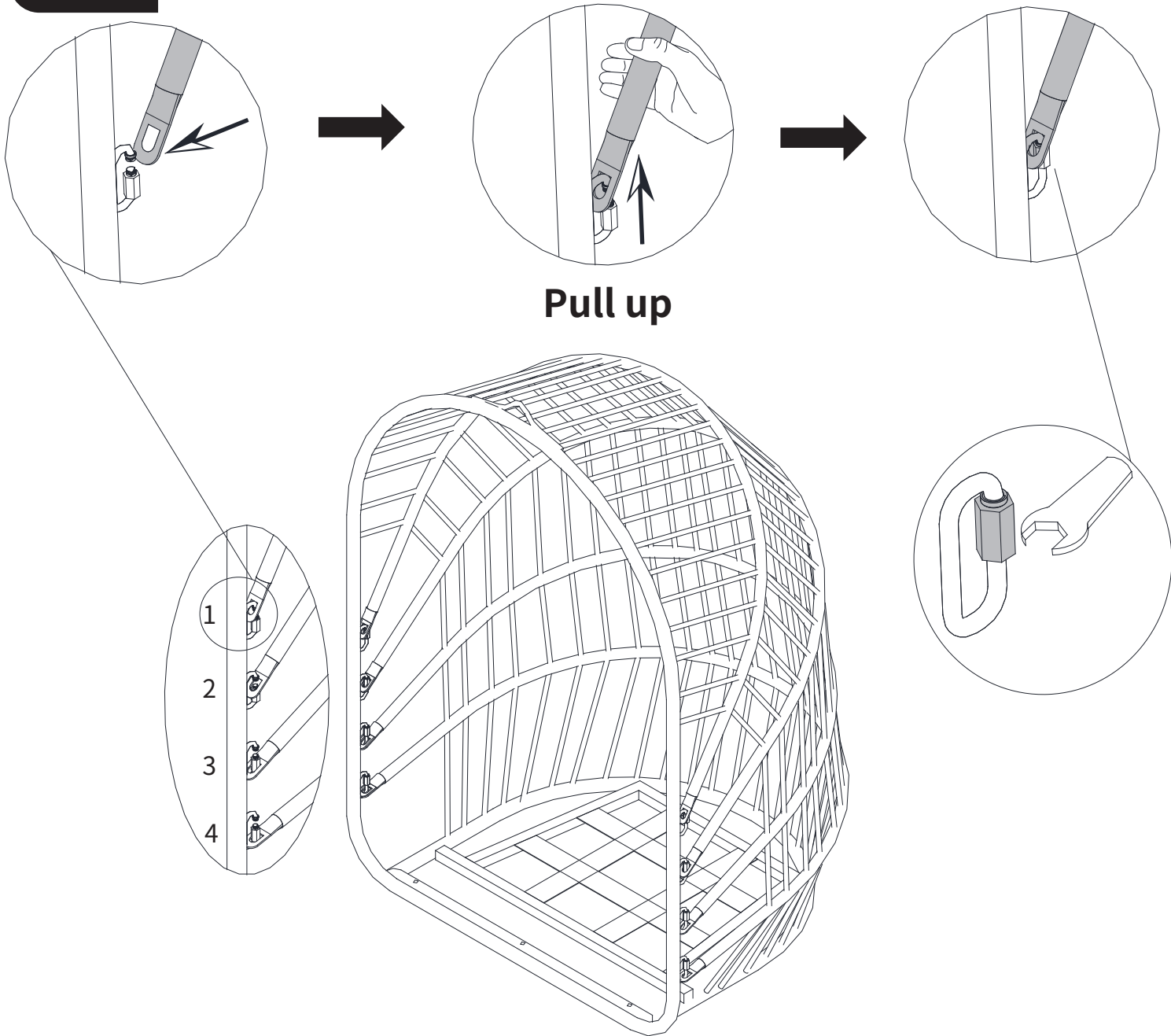

The second nut can be installed only after the first nut is tightened

4

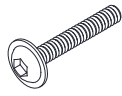

A x3



B x3

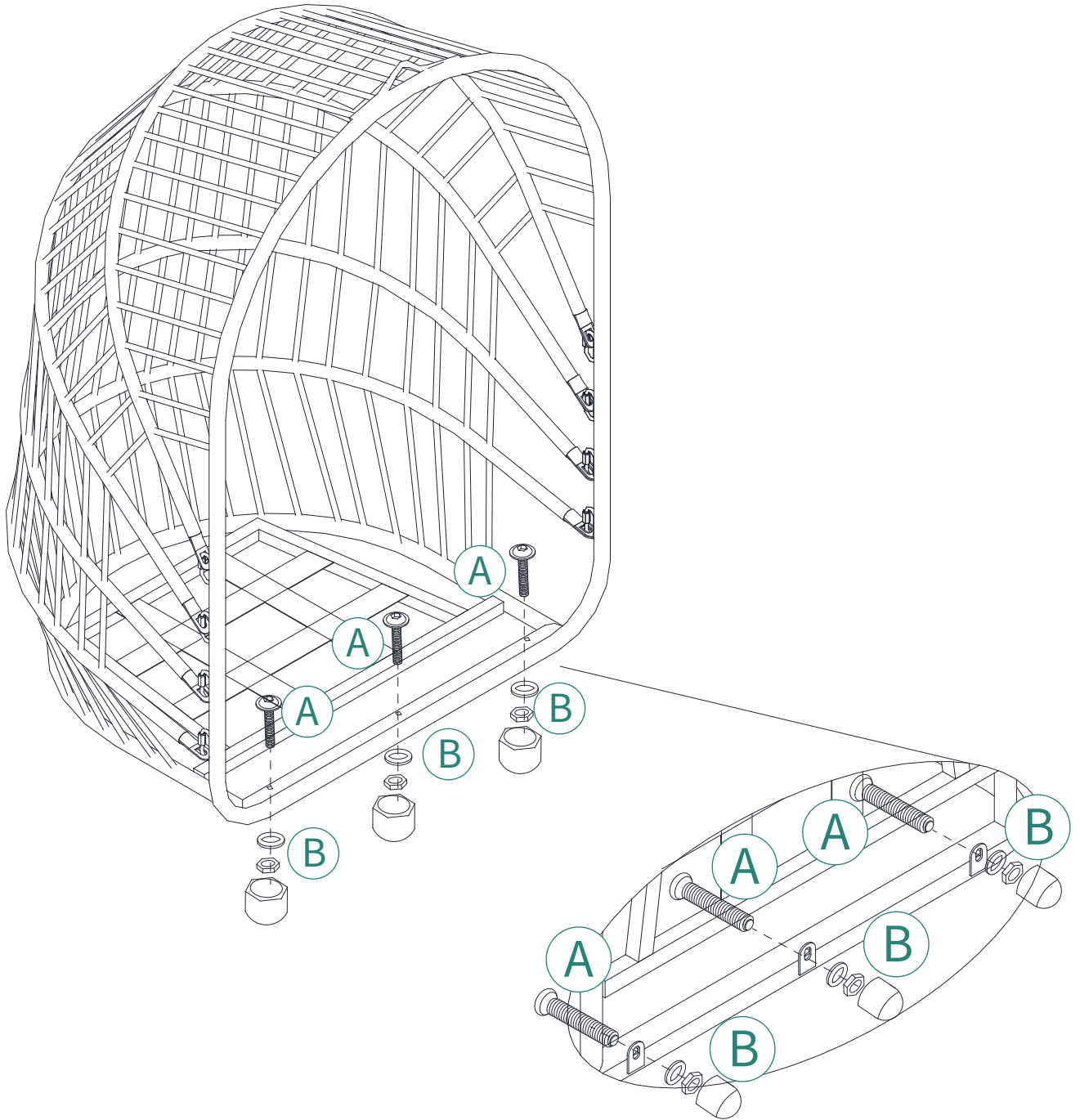

5

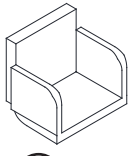

②x1

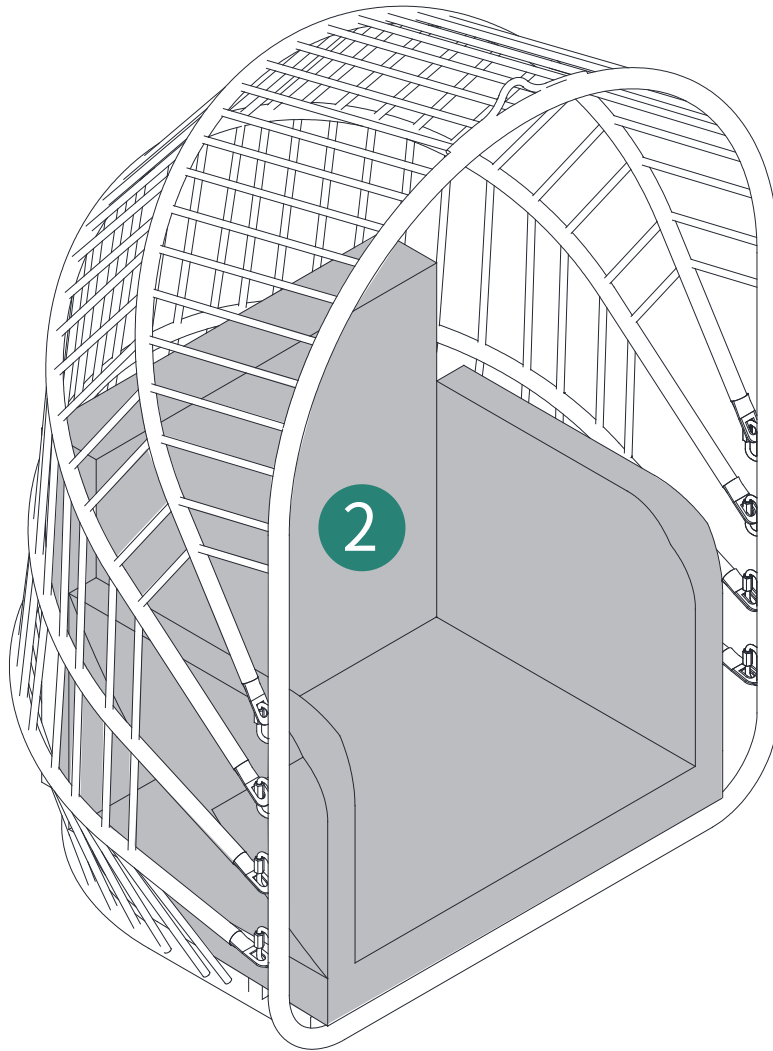

6

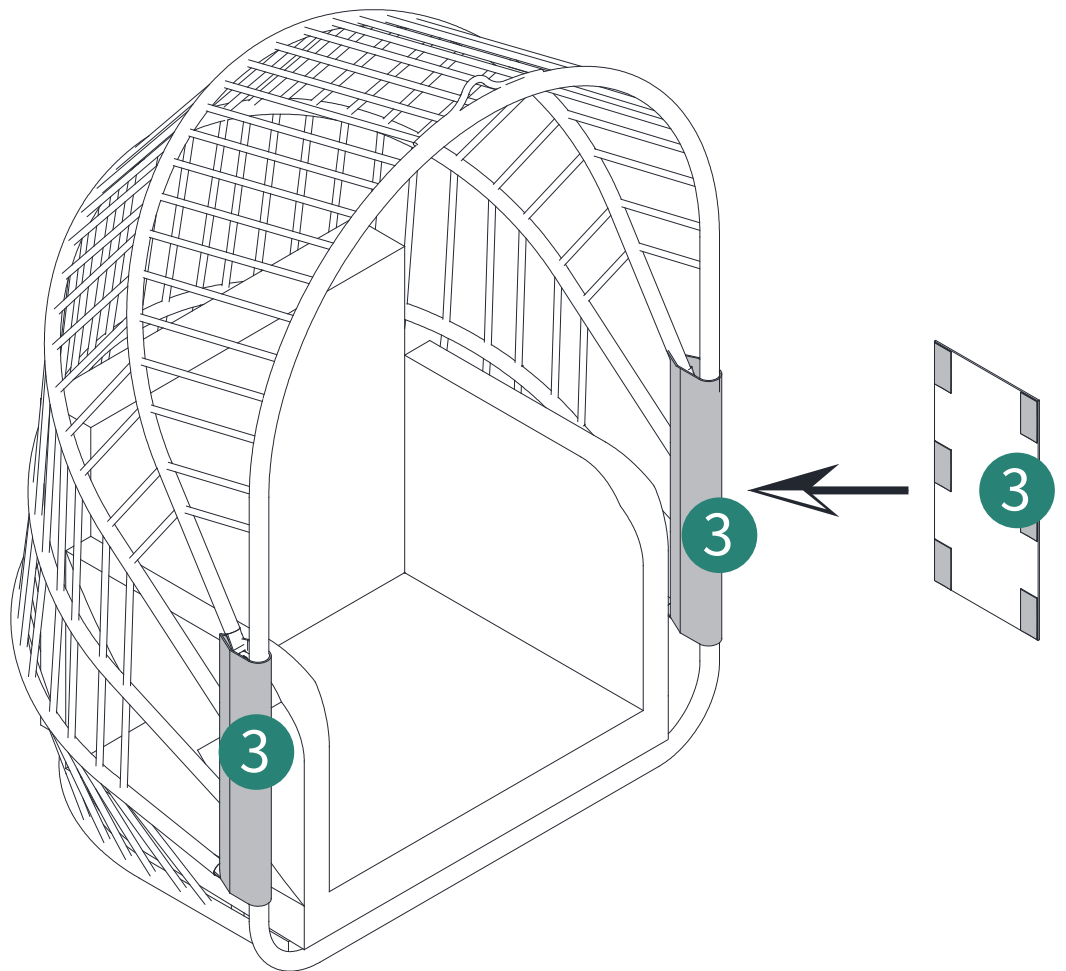
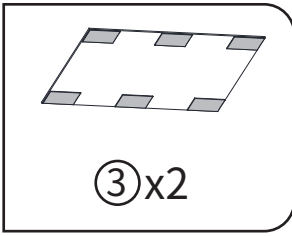

7

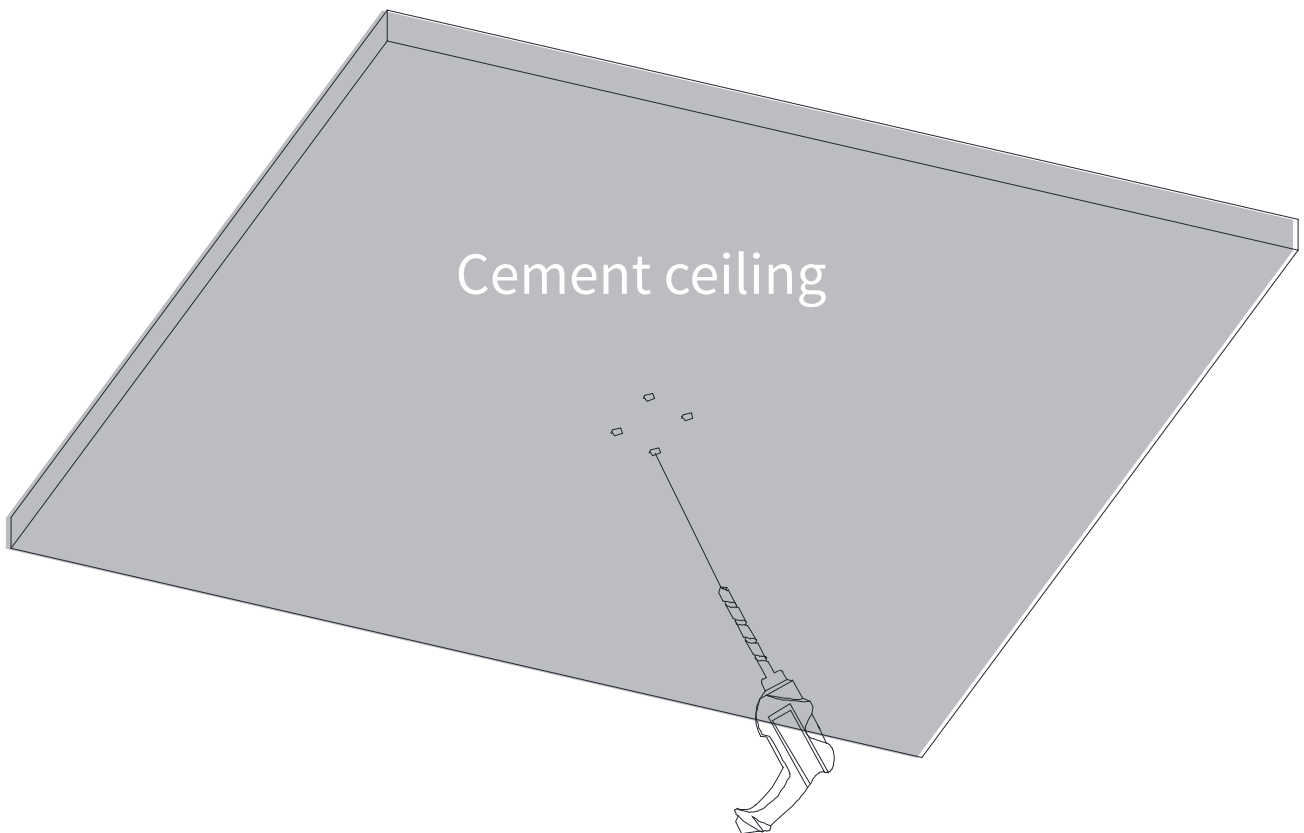

The power drill is required for drilling holes in the ceiling, but it is not included. Customers need to provide their own drill.

Note: Can not be mounted on wooden ceiling

8

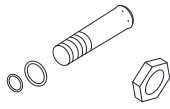

ⓐx4



ⓓx1

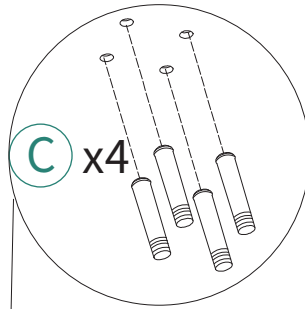

ⓐx4

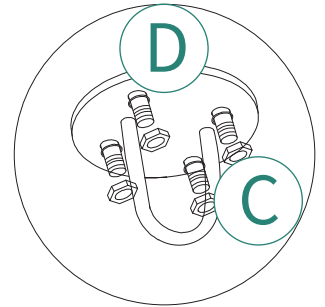

ⓓ

ⓐ

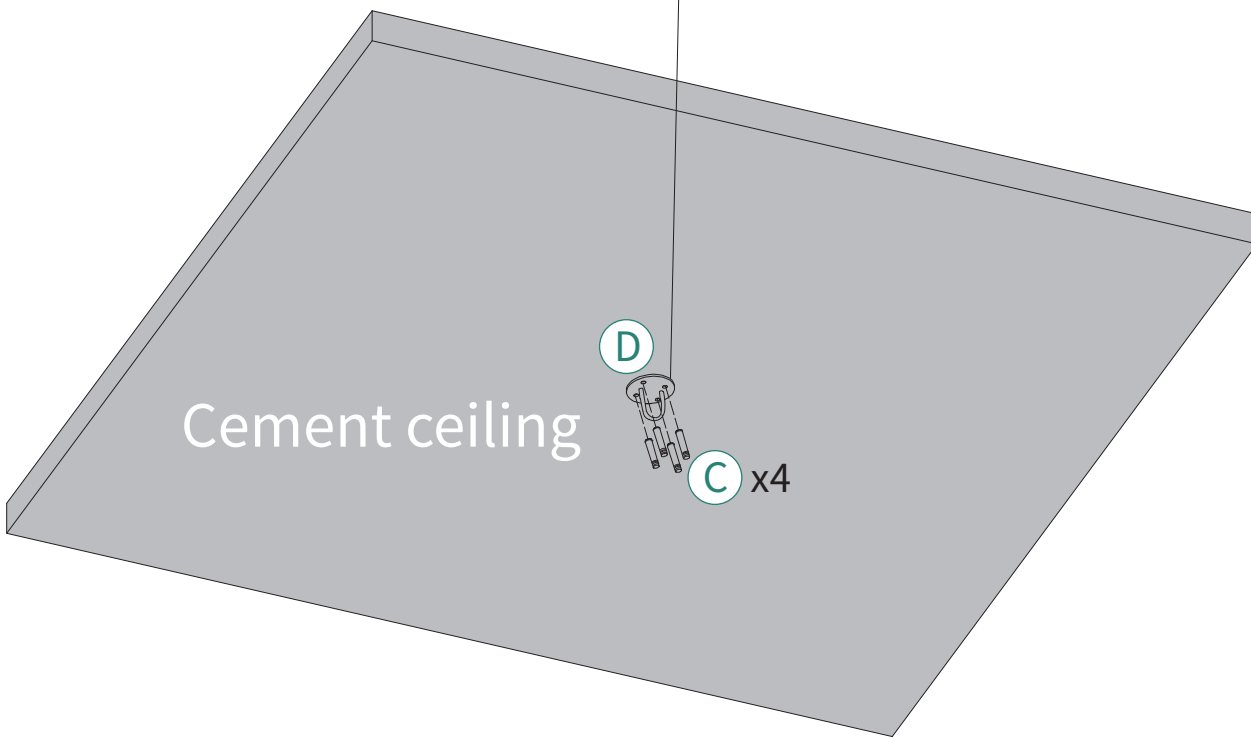

Cement ceiling

ⓓ

ⓐx4

9

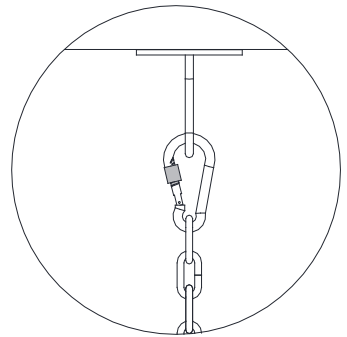
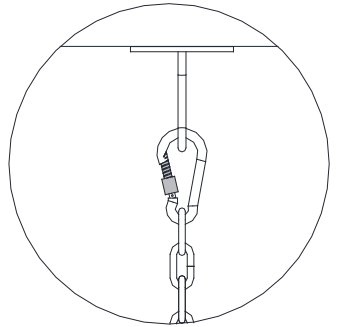
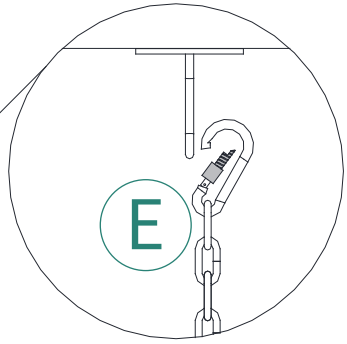
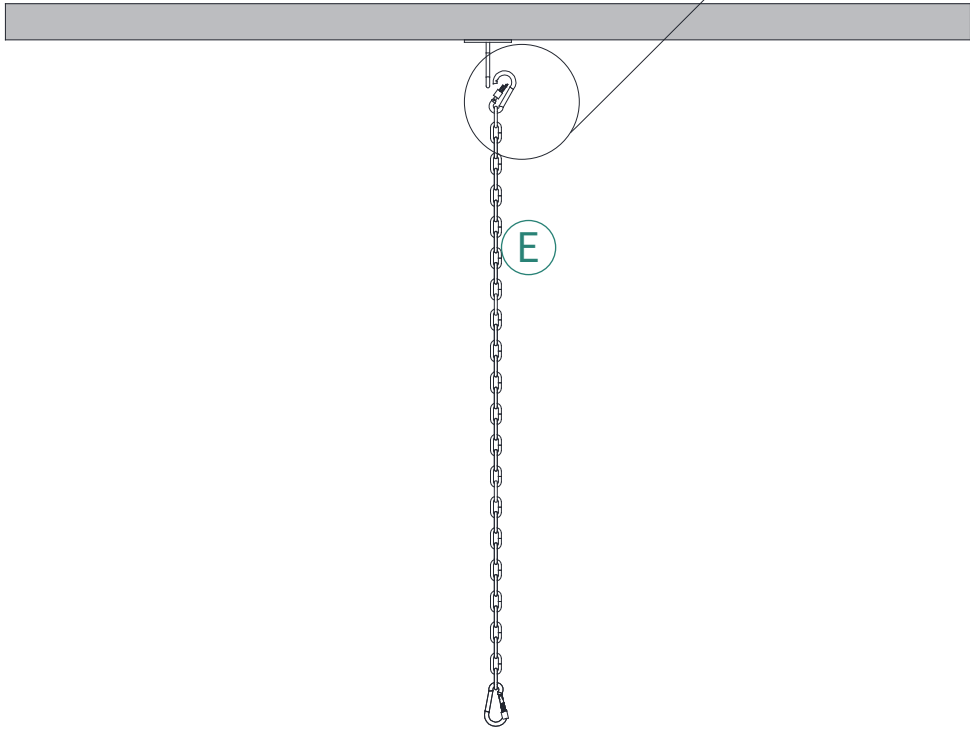
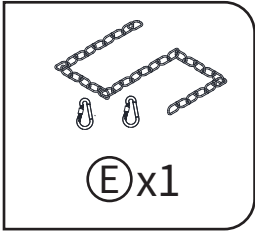

10

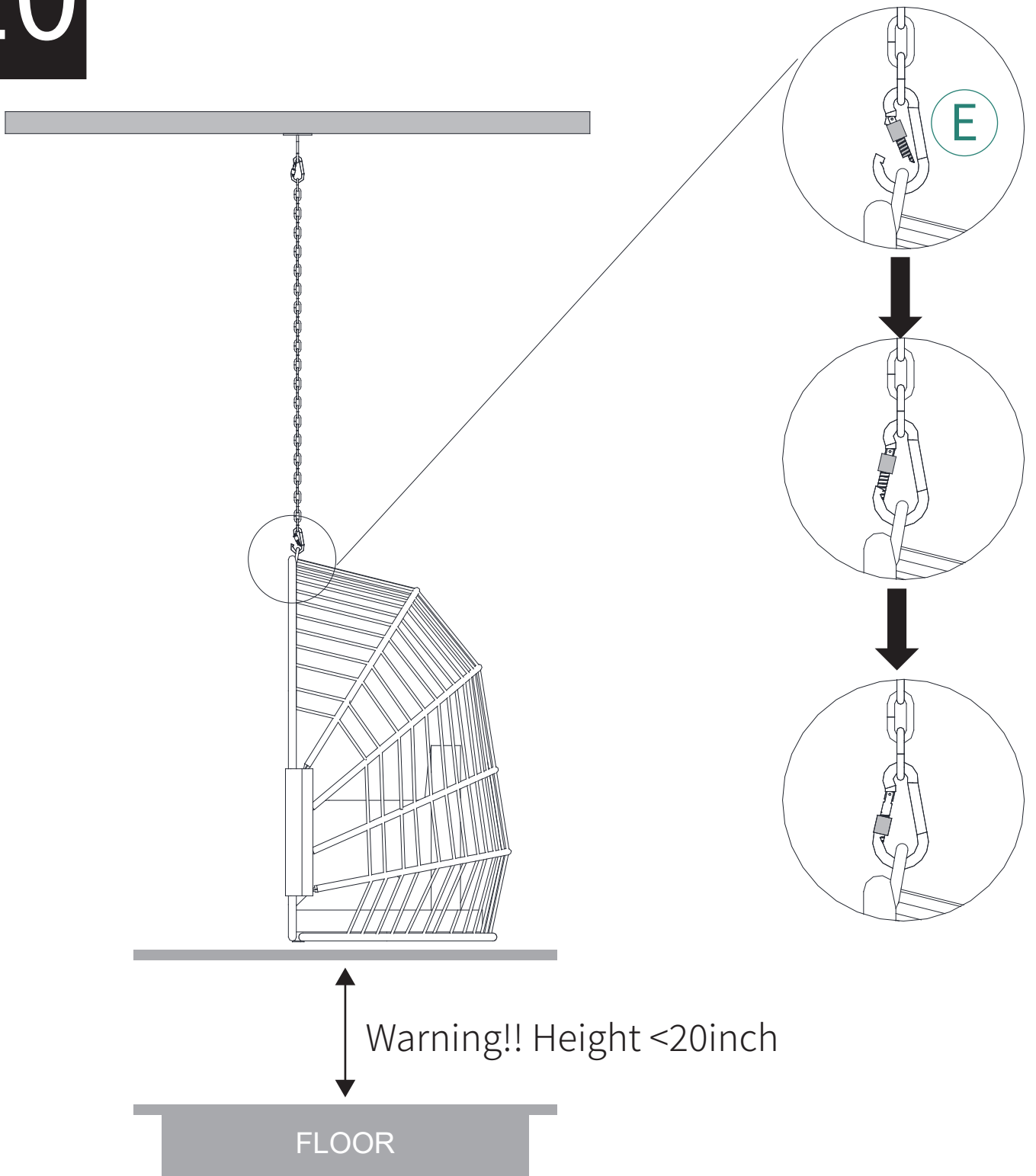

Install 3.3ft chain with 2 buckles (E) to the basket, your hanging chair is ready for use.

HELP CENTER



Inquiry



Assembly issue



Missing parts

If you encounter any difficulties during assembly, please contact us.
Wenn Sie während der Montage auf Schwierigkeiten stoßen, kontaktieren Sie uns bitte.
Si vous rencontrez des difficultés lors du montage, veuillez nous contacter.
Se incontri difficoltà durante il montaggio, ti preghiamo di contattarci.
Si encuentras alguna dificultad durante el ensamblaje, por favor contáctanos.

DISCLAIMER

Manufacturer and seller expressly disclaim any and all liability for personal injury, property damage or loss, whether direct, indirect, or incidental, resulting from the incorrect attachment, improper use, inadequate maintenance, unapproved modification, or neglect of this product.

Der Hersteller und Verkäufer lehnen ausdrücklich jegliche Haftung für Personenschäden, Sachschäden oder Verluste ab, egal ob direkt, indirekt oder zufällig, die durch falsche Anbringung, unsachgemäßen Gebrauch, unzureichende Wartung, nicht genehmigte Änderungen oder Vernachlässigung dieses Produkts entstehen.

El fabricante y vendedor renuncian expresamente a toda responsabilidad por lesiones personales, daños materiales o pérdidas, ya sean directos, indirectos o incidentales, derivados de la incorrecta colocación, uso inadecuado, mantenimiento insuficiente, modificación no aprobada o negligencia de este producto.

Il produttore e il venditore declinano espressamente ogni responsabilità per lesioni personali, danni materiali o perdite, dirette, indirette o incidentali, derivanti dall'errato fissaggio, uso improprio, manutenzione inadeguata, modifica non autorizzata o negligenza di questo prodotto.

Le fabricant et le vendeur déclinent expressément toute responsabilité en cas de blessures corporelles, de dommages matériels ou de pertes, qu'ils soient directs, indirects ou accessoires, résultant de la fixation incorrecte, de l'utilisation inappropriée, de l'entretien insuffisant, de la modification non approuvée ou de la négligence de ce produit.