

10 Install E26 Light Bulb(Not Included)

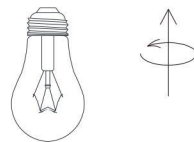
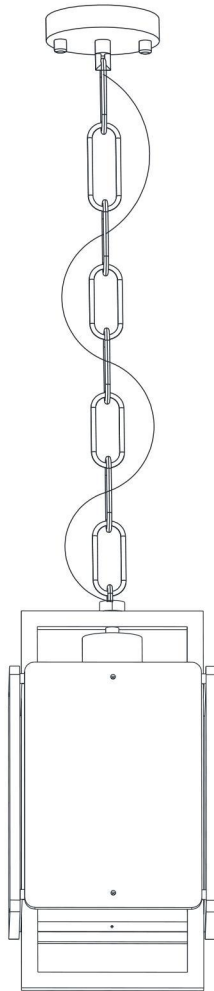

Your installation is now complete! Restore electricity and save this sheet for future reference.

INSTALLATION GUIDE

WARNINGS AND CAUTIONS

READ AND SAVE THESE INSTRUCTIONS

Please read and understand this entire manual before attempting to assemble, install or operate the product.

WARNING

- RISK OF ELECTRIC SHOCK - Before beginning installation, turn off electricity at the circuit breaker box or the main fuse box.
- RISK OF FIRE - Use bulbs specified by the markings and/or labels on the fixture.

CAUTION

- For your safety, read instructions completely before beginning installation.
- If in doubt about electrical installation, consult a licensed electrician.
- Turn off electricity to fixture before replacing the bulb(s).

TOOLS REQUIRED

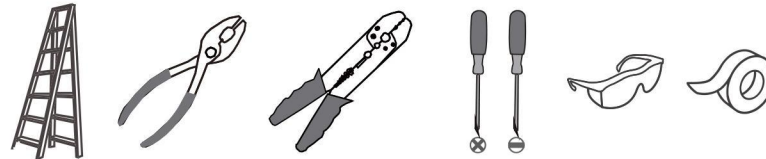

CARE AND MAINTENANCE

- Wipe clean using soft, dry cloth or static duster. Always avoid using harsh chemicals and abrasives to clean fixture as they may damage the finish.

PACKAGE CONTENTS

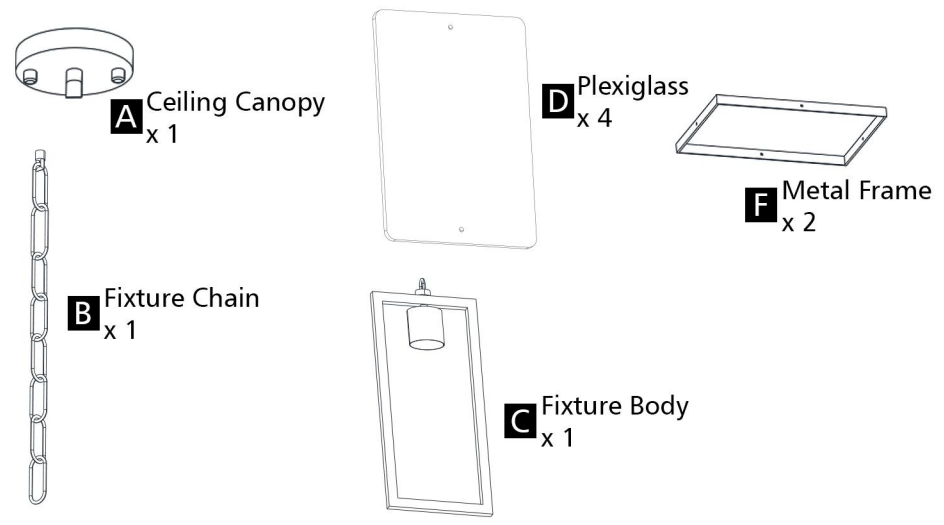

PACKAGE CONTENTS (PARTS BAG 1)

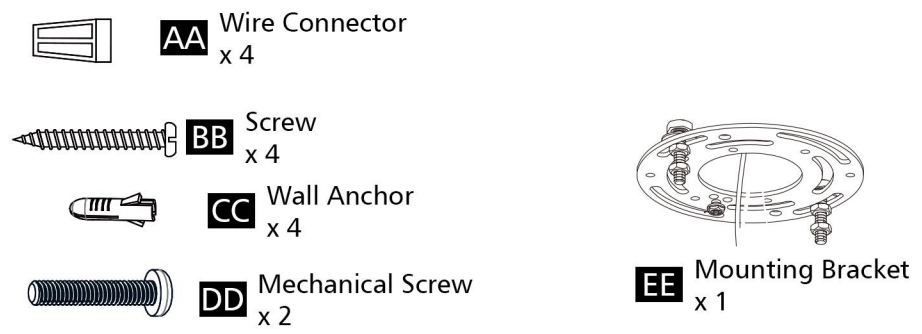

PACKAGE CONTENTS (PARTS BAG 2)

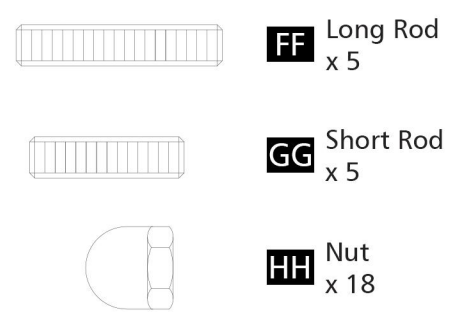

INSTALLATION

9 Fix the ceiling canopy to the mounting bracket with the nut

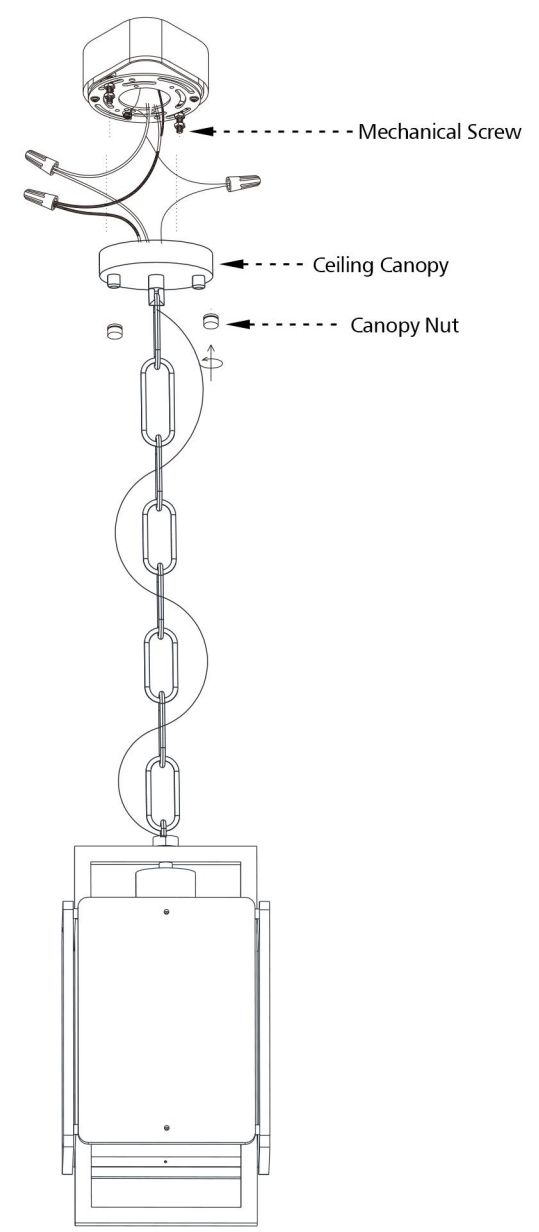

INSTALLATION

7 Install the Mounting Bracket

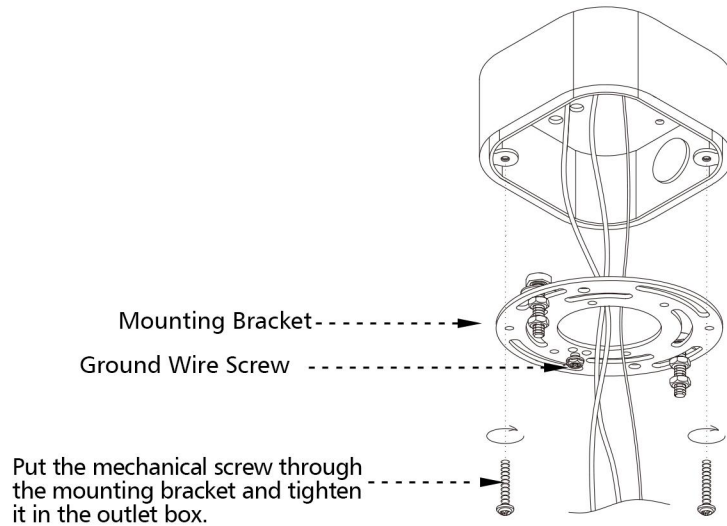

8 Wiring

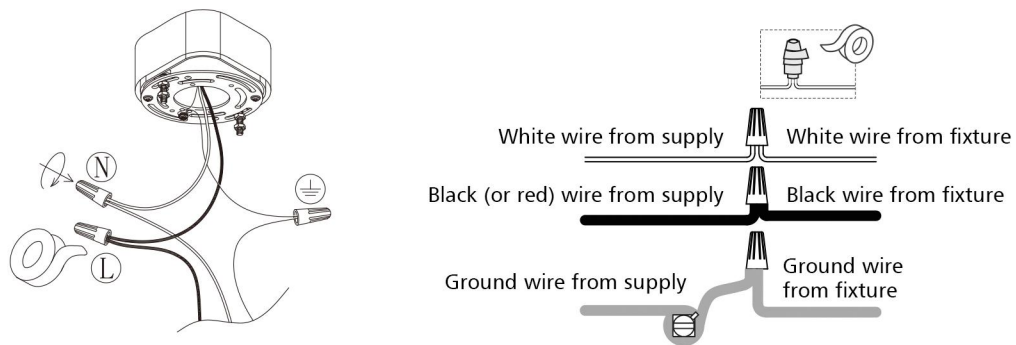

INSTALLATION

1 Connecting Rods and Nuts

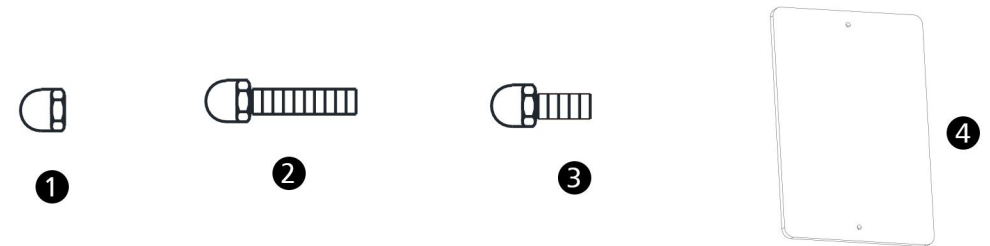

1. Connect the rod and nut like 2 and 3.
2. A total of four 2 and four 3 are required.

2 Put four 2 through the fixture body, metal frame and plexiglass (at the four arrows) and connect the nut

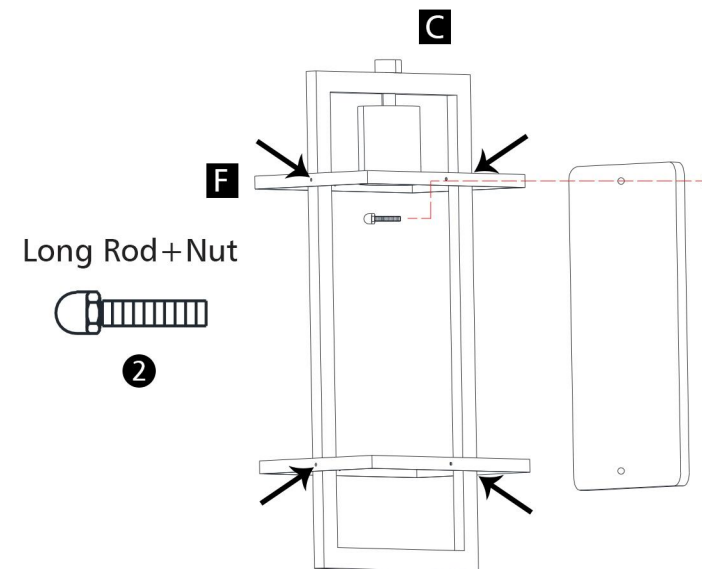

INSTALLATION

- 3** Put four **3** through the metal frame and plexiglass and connect the nut

Short Rod+Nut



3

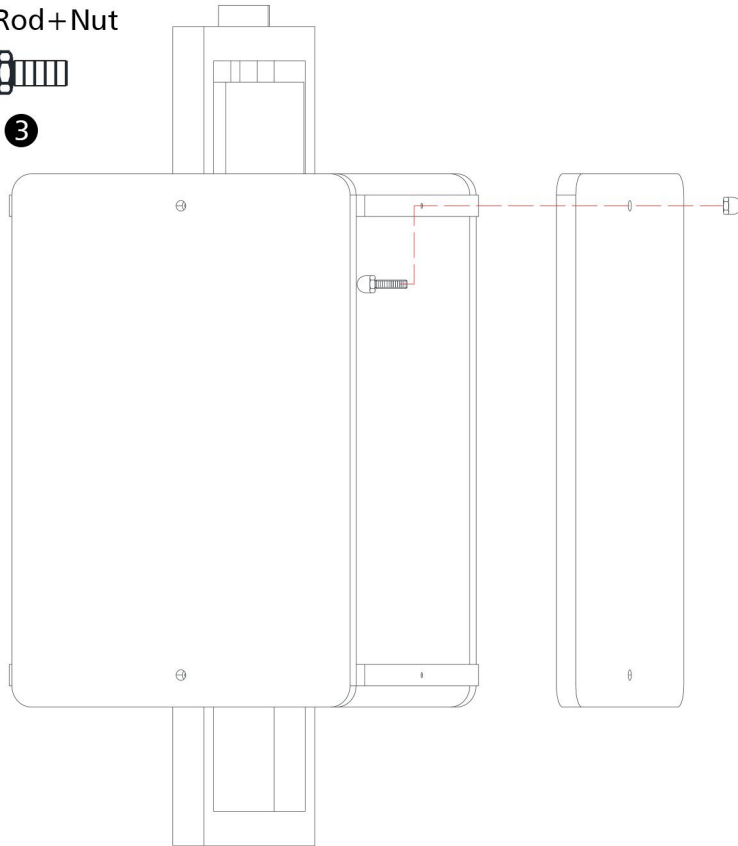

INSTALLATION

- 4** 1. Screw the bottom of the fixture chain **1** into the fixture body.
2. Screw the top of the fixture chain **2** into the ceiling canopy.

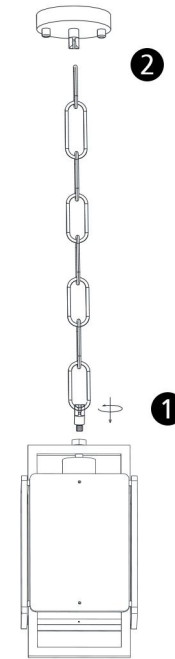

- 5** Wire Run Through the Ceiling Canopy

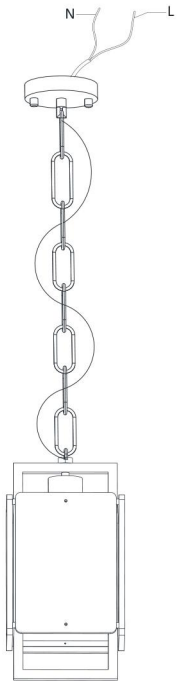

- 6** 1. Unscrew the nuts **1** on both sides of the ceiling canopy.
2. Take out the mounting bracket **2**.

