

# **INSTRUCTION MANUAL**

## **Aluminum Splicing Dining Table**

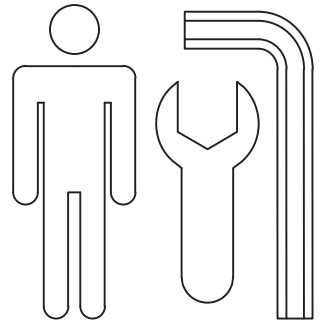



Part Number	Images and Sizes	Qty.
A		4
B		2
C		2
D		2

M		28	I	 M8*30	8	E		2
N		1	J		28	F		4
O	 M6	1	K		28	G		1
			L		28	H	 M8*35	20

## ASSEMBLY INSTRUCTIONS



### CAVEAT

Note: Please only tighten any bolts once all bolts are placed correctly and the product is lying flat. If you tighten one bolt, it may cause other bolts to get out of position.

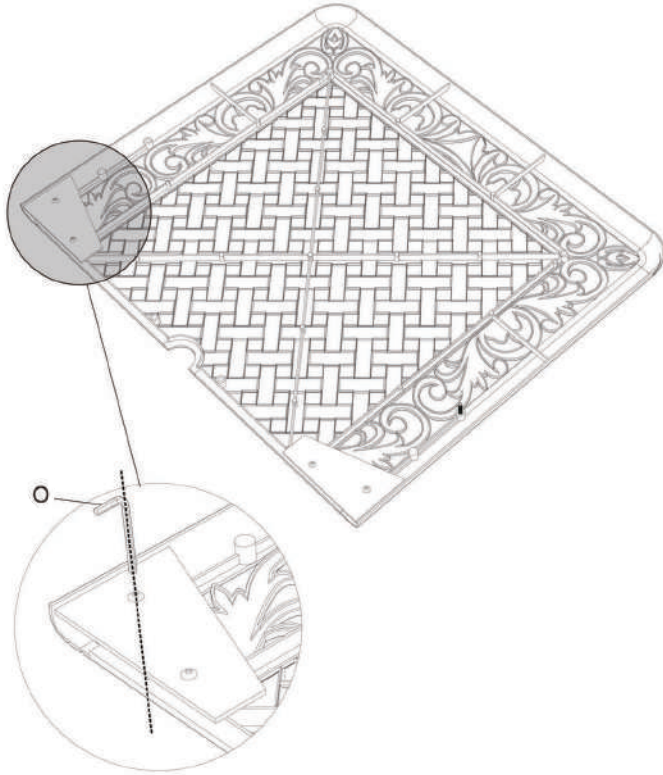

### STEP 1

Please remove these 4 protective steel pieces before assembling. (2 pieces per tabletop)

## ASSEMBLY INSTRUCTIONS



### CAVEAT

Note: Please only tighten any bolts once all bolts are placed correctly and the product is lying flat. If you tighten one bolt, it may cause other bolts to get out of position.

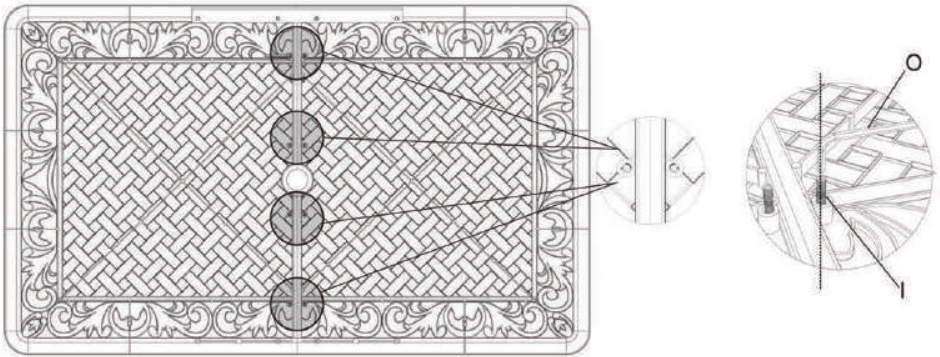

### STEP 2

Attach the 2pcs of backside tabletop (D) using 8 bolts (I). Do not over-tighten.

## ASSEMBLY INSTRUCTIONS



### CAVEAT

Note: Please only tighten any bolts once all bolts are placed correctly and the product is lying flat. If you tighten one bolt, it may cause other bolts to get out of position.

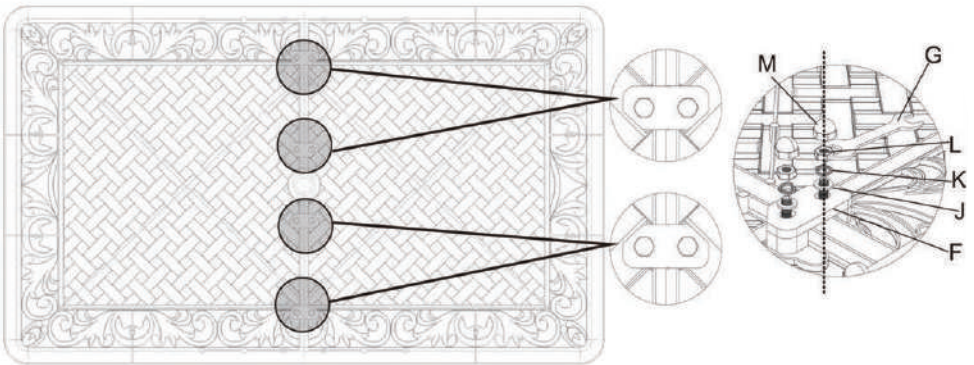

### STEP 3

Fixed the 4pcs of fixed buckle (F) to the tabletop (D) using 8 nuts (L), 8 spring washers (K), and 8 washers (J). Do not over-tighten.

## ASSEMBLY INSTRUCTIONS



### CAVEAT

Note: Please only tighten any bolts once all bolts place correctly and the product is lying flat. If you tighten one bolt, it may cause other bolts to get out of position.

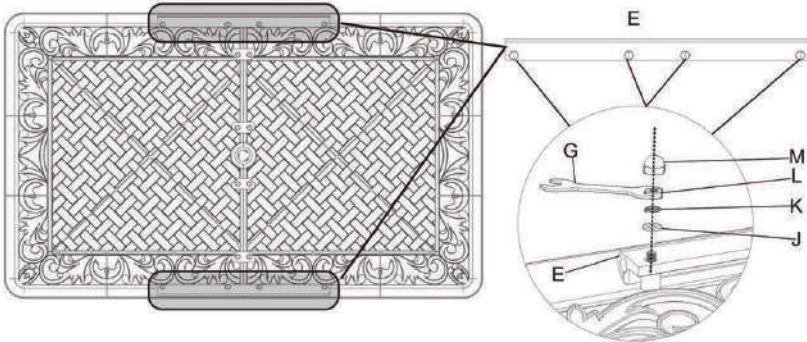
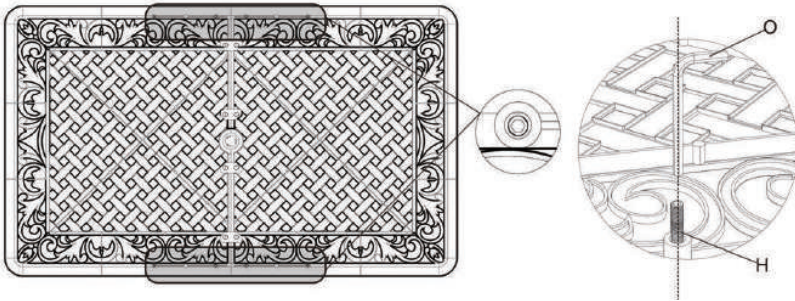

### STEP 4

Fixed the 2pcs support bar (E) to the tabletop using 8 bolts (H), 8 nuts (L), 8 spring washers (K), and 8 washers (J). Do not over-tighten.

## ASSEMBLY INSTRUCTIONS



### CAVEAT

Note: Please only tighten any bolts once all bolts are placed correctly and the product is lying flat. If you tighten one bolt, it may cause other bolts to get out of position.

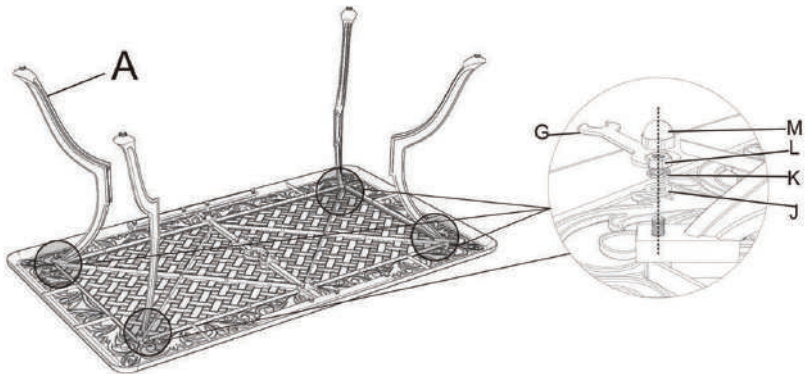
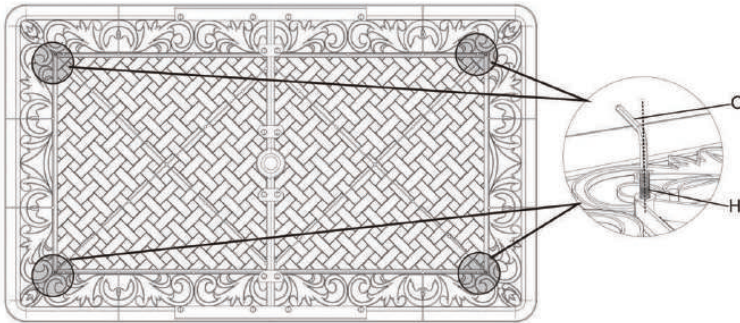

### STEP 5

Attach the 4 legs (A) to the tabletop using 4 bolts (H), 4 nuts (L), 4 spring washers (K), and 4 washers (J). Do not over-tighten.

## ASSEMBLY INSTRUCTIONS

### CAVEAT

Note: Please only tighten any bolts once all bolts are placed correctly and the product is lying flat. If you tighten one bolt, it may cause other bolts to get out of position.

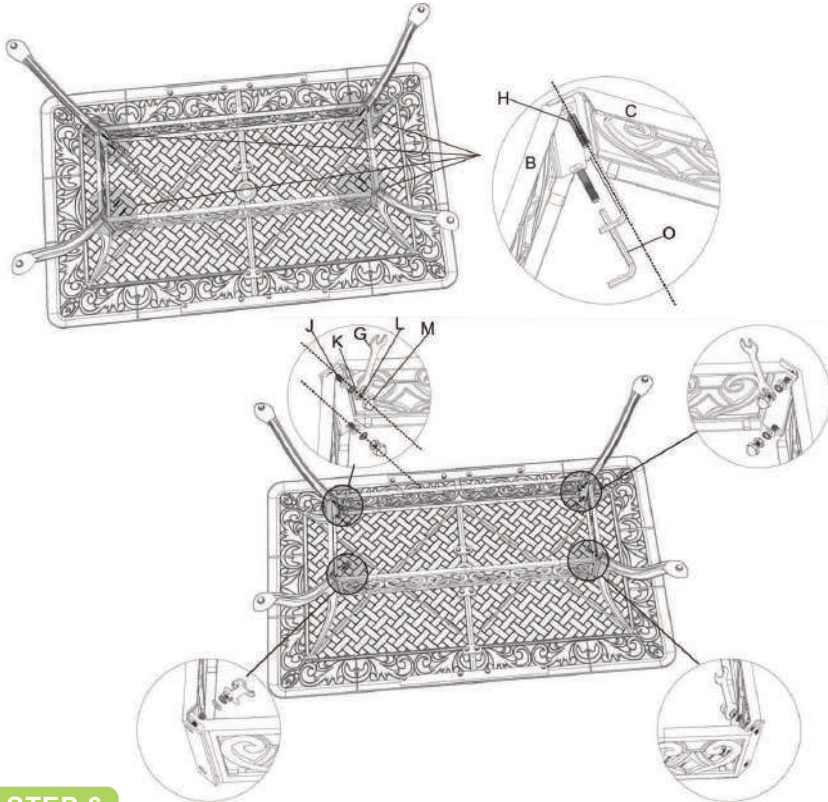

### STEP 6

Attach the 2 fixed frames (B) and 2 fixed frames (C) to the tabletop using 8 bolts (H), 8 nuts (L), 8 spring washers (K), and 8 washers (J). Do not over-tighten.

## ASSEMBLY INSTRUCTIONS



### CAVEAT

Note: Please only tighten any bolts once all bolts are placed correctly and the product is lying flat. If you tighten one bolt, it may cause other bolts to get out of position.

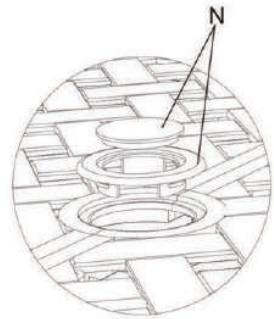

### STEP 7

Put the umbrella cover (N) into the tabletop umbrella hole.

## ASSEMBLY INSTRUCTIONS



### CAVEAT

Note: Please only tighten any bolts once all bolts place correctly and the product is lying flat. If you tighten one bolt, it may cause other bolts to get out of position.



### STEP 8

The legs with regulator make it in good balance.

Upon completing the entire assembly and bolting up, you can tighten down all screws and add the protective hats (M) to all bolts.

## **CARE AND MAINTENANCE**

Follow the instructions for the product's material to ensure it stays in the best shape as long as possible. The information below is a general guideline.

Don't hesitate to get in touch with us to learn more.

- Only rinse it thoroughly with clean water to wash away dirt and grime. Never use abrasive cleansers on the furniture since they can attack the surface and leave behind scratch marks.
- For stubborn grime and stains, use a soft sponge and mild soapy water. Then dry it with a cloth or paper towel.
- Check the stability of the screws, nuts, and nut caps before each use. Then, tighten them up after one to two months' use whenever required.
- Avoid improper use, and be careful not to scratch or damage the surface with sharp objects.
- When you move your furniture, lift it rather than pulling or pushing it to avoid damaging the floor, legs, and mounting.