

CIRRUS

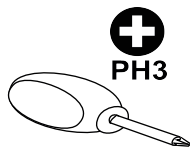

45min

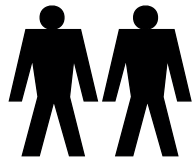

PH3

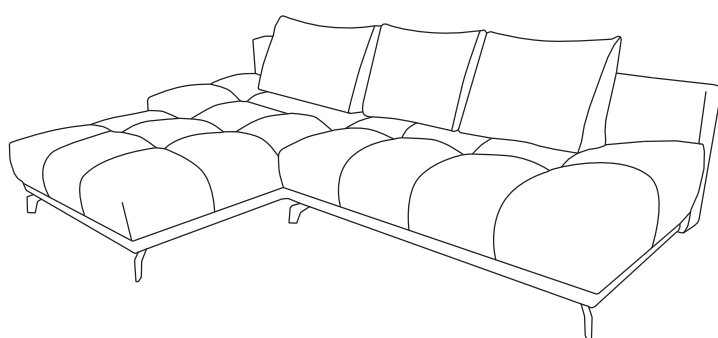
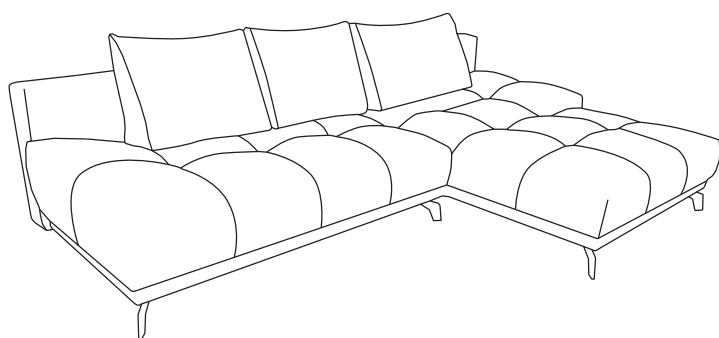

I

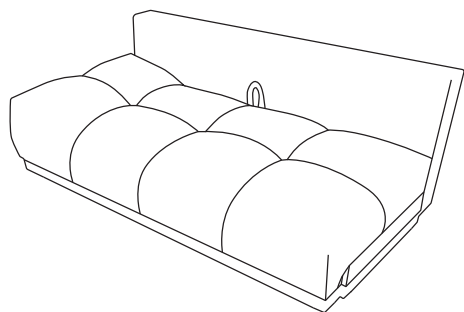

II

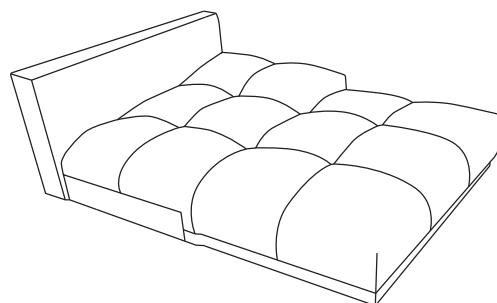

III

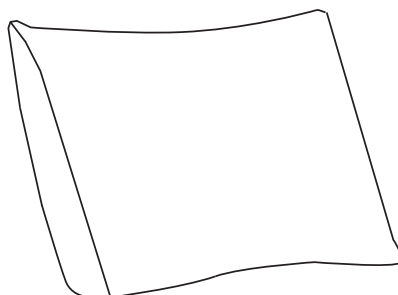

x3

Ax4

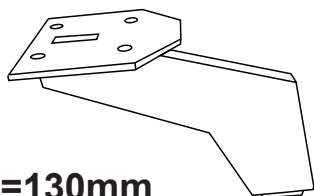

H=130mm

Bx4

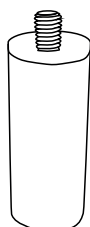

H=100mm

Cx2



H=130mm

Dx16

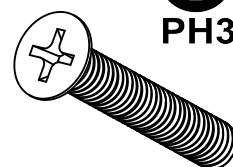

6x35

PH3

1

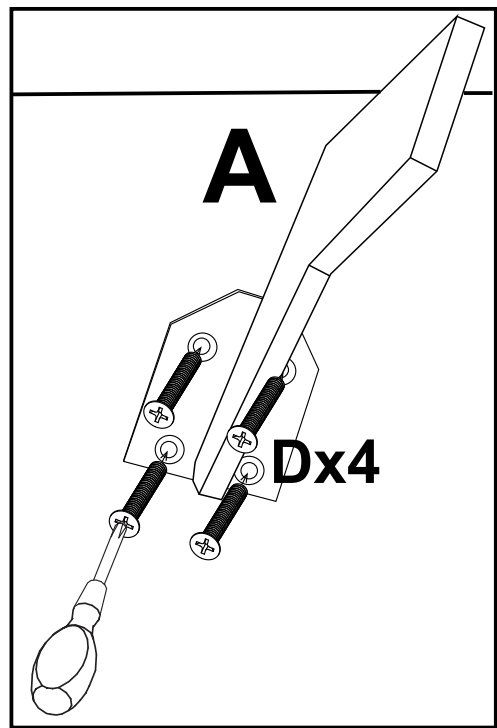
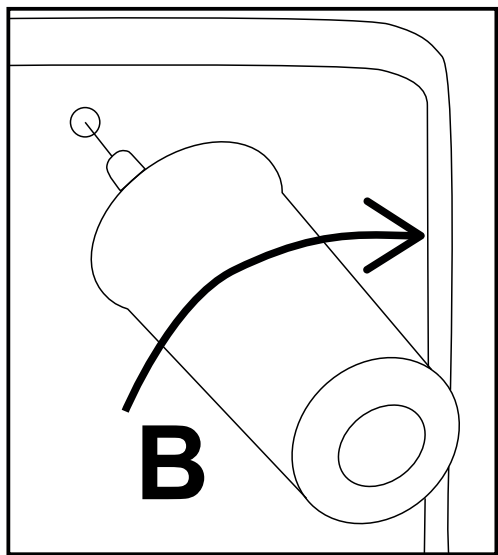
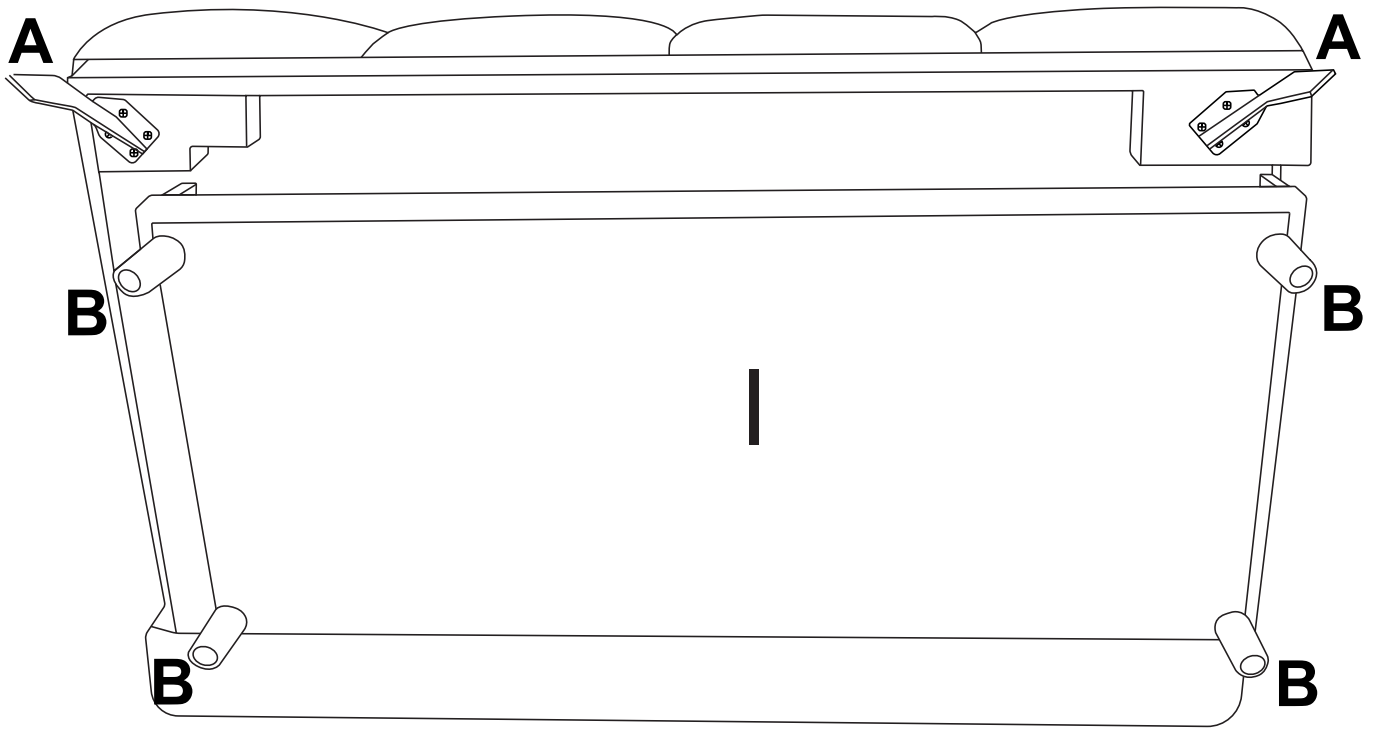
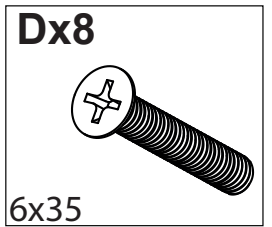
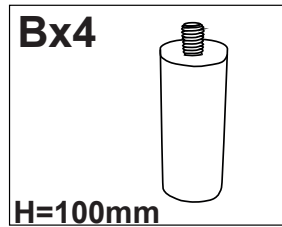
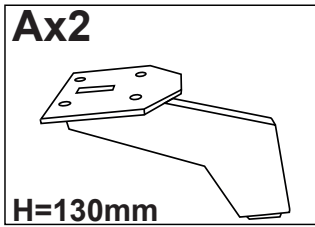

2

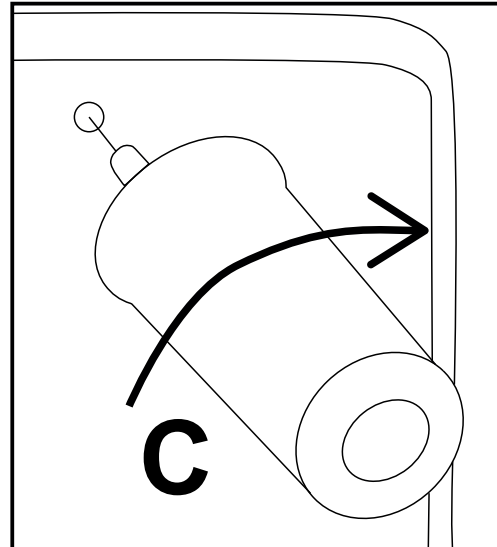
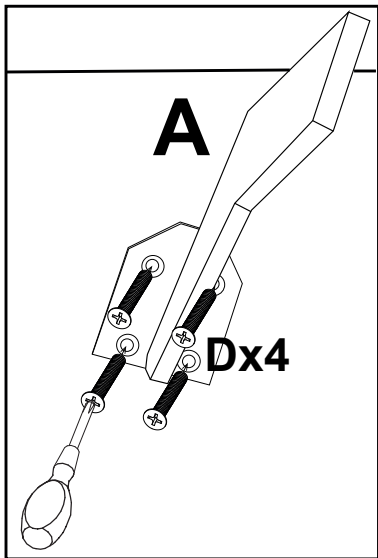
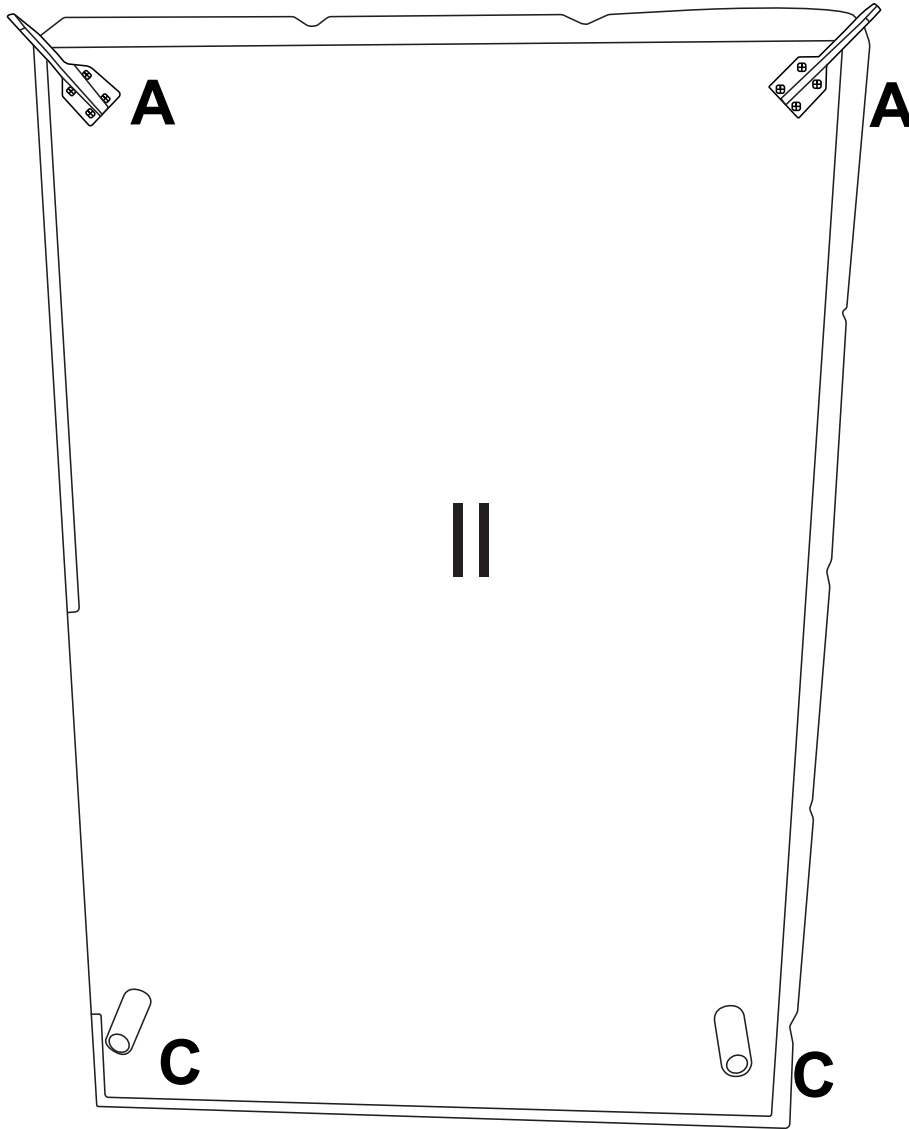
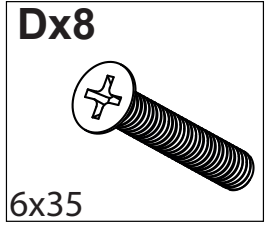
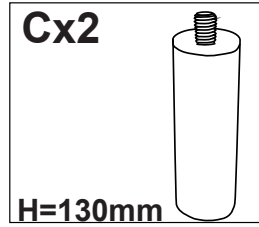
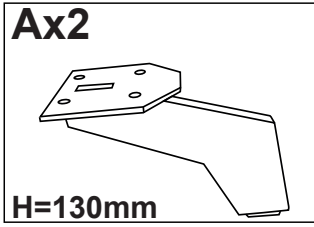

3

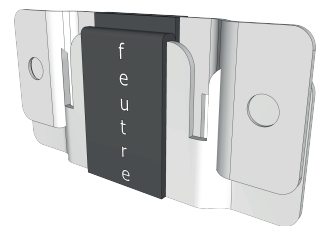
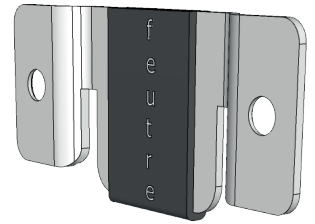
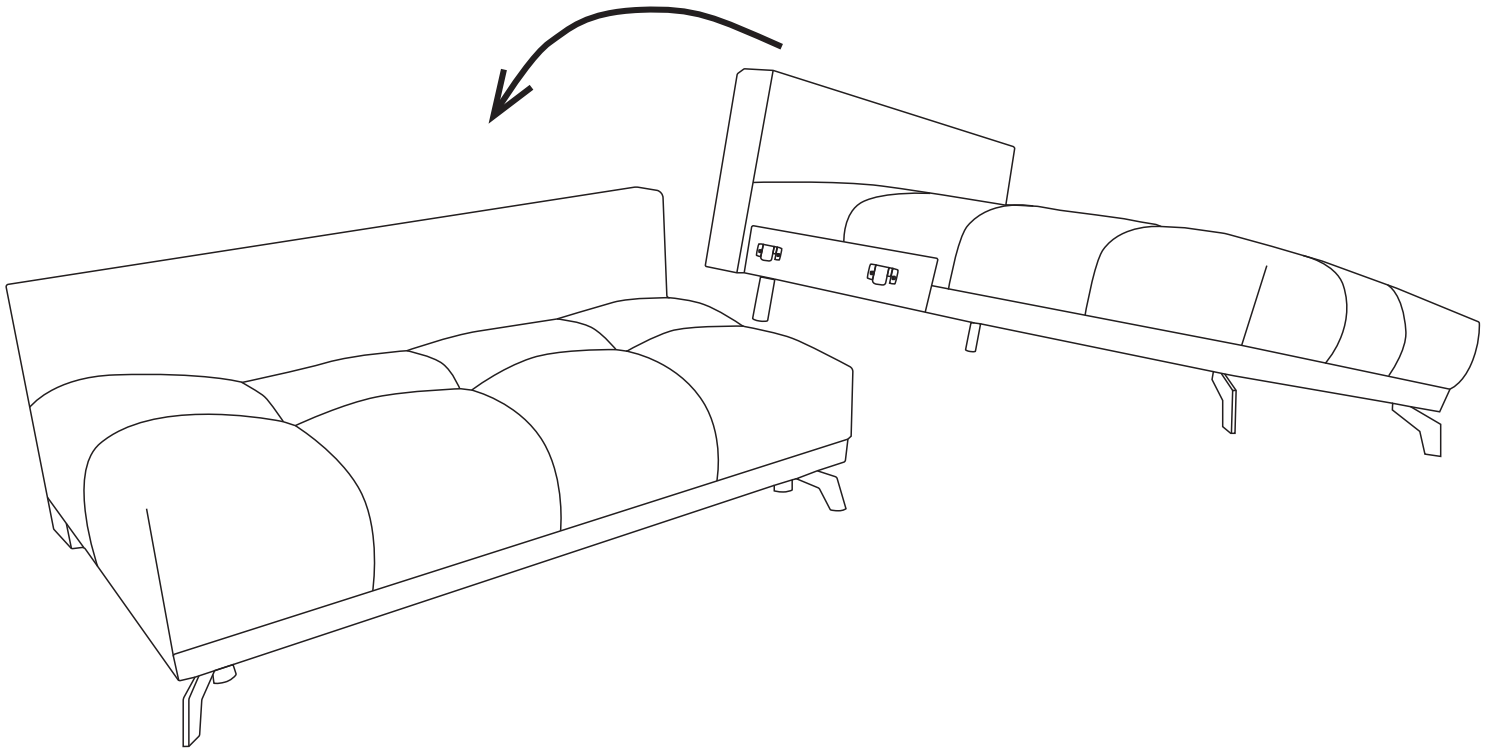

4

