

ASSEMBLY INSTRUCTIONS

- (A)** 2x Iron Plate
- (B)** 4x Screws
- (C)** 8x Flat Shelf Pins
- (D)** 2x Shelves
- (E)** Wall Mount - Anti Tip Kit

*** Note:** The L Hex Key is used for both product and wall mount assembly. It can be found in the Wall Mount - Anti Tip Kit (Part E).

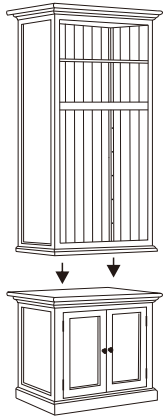

Step 1

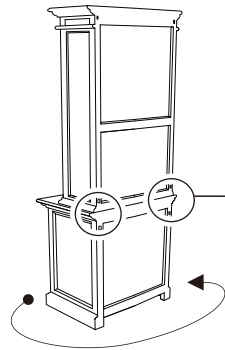

Step 2

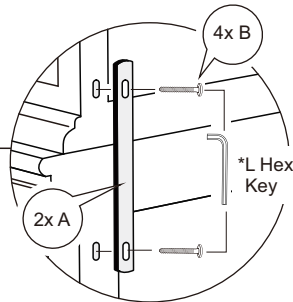

Step 3

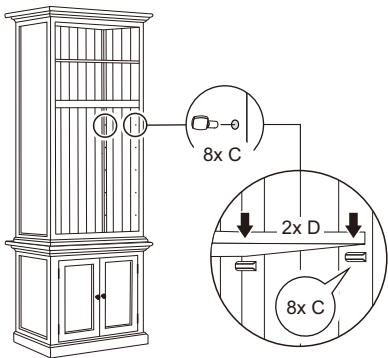
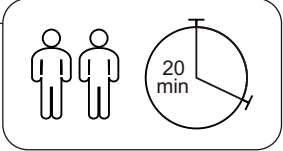

Step 4

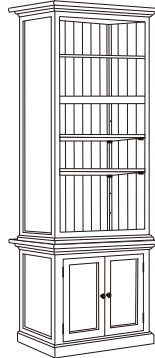

Step 5

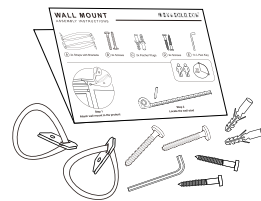

WARNING

Always use the proper tools during assembly. Follow the assembly steps in order. DO NOT skip any steps. Be sure to check all packing materials carefully for assembly hardware. If any parts are missing, contact the retailer from which you purchased the product to obtain any missing parts. DO NOT USE SUBSTITUTE PARTS. During assembly tighten screws first by hand. Once all screws are in place use the tool provided to tighten. Periodically check to ensure that all hardware (bolts, screws, etc.) are tight. DO NOT stand on the product during assembly. Where assembly instructions state that assembly requires two or more people, DO NOT attempt to assemble by yourself as there is a risk of injury.

WALL MOUNT ASSEMBLY INSTRUCTIONS

- (A)** 2x Straps with Brackets
- (B)** 2x Screws
- (C)** 2x Fischer Plugs
- (D)** 2x Screws
- (E)** 1x L Hex Key

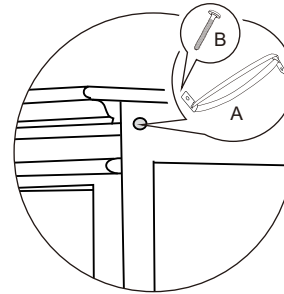

Step 1

Attach wall mount to the product
Find the 2 holes on the backside of the product. They are located on the top left and top right corners of the product. Securely install Part A and Part B in each hole. Tighten with Part E.

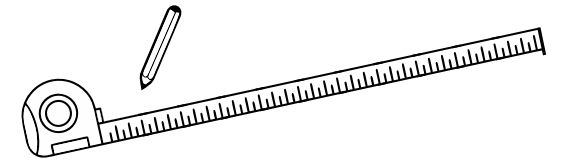

Step 2

Locate the wall stud

Place the product against the wall to determine where it will be anchored. Use a stud finder to locate the wall stud. Mark on the wall in pencil where the wall mount straps will be attached into the wall stud. Measure to ensure the distance between the 2 markings on the wall is equal to the distance between the 2 straps on the product.

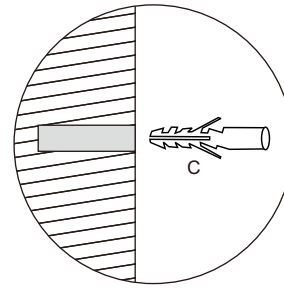

Step 3

Drill holes in the wall

Drill 2 holes in the wall based on the pencil markings in Step 2 to install Part C.

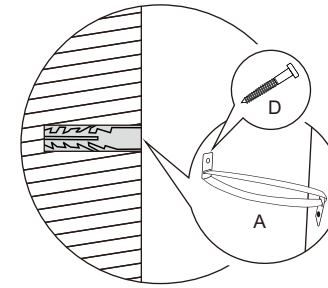

Step 4

Attach wall mount to the wall stud

Using Part D safely secure Part A from the back of the product to the wall.

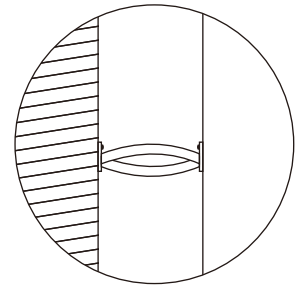

Step 5

Enjoy!

The wall mount is installed and the product is ready to use.

WARNING

Serious or fatal crushing injuries can occur from furniture tip-over. To prevent this furniture from tipping over it must be permanently fixed to the wall with the included wall attachment devices. Please note the fastening devices included are not suitable for all wall types. Use fastening devices suitable for the walls in your home. For advice on suitable fastening devices, please contact your local hardware store.