

As this item contains many parts, please read the installation instruction carefully before installation and complete the installation with the cooperation of your partner. Please use tools properly and carefully. If you have any questions about the product and installation, please contact us.

Our professional after-sales team will serve you online all day.

Before You Start

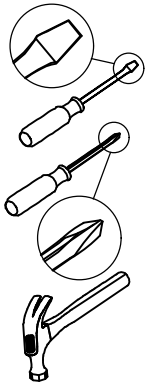

- ✓ Read through each step carefully and follow the proper order
- ✓ Separate and count all your parts and hardware
- ✓ Give yourself enough room for the assembly process
- ✓ Have the following tools: Flat Head Screwdriver, #2 Phillips Head Screwdriver and Hammer
- ✓ Caution: If using a power drill or power screwdriver for screwing, please be aware of to slow down and stop when screw is tight. Failure to do so may result in stripping the screw.

Helpful Hints

PEOPLE NEEDED FOR ASSEMBLY: 1-2

- Open your item in the area you plan to keep it to avoid excessive heavy lifting.
- Identify, sort and count the parts before attempting assembly.
- Compression dowels are lightly tapped in with a hammer.
- Slides are labeled with an **R** (right) and **L** (left) for proper placement.
- Make sure to always face the point on the top of the Cam Lock towards the outer edge.
- Use all the nails provided for the back panel and spread them out equally.
- Back panel must be used to make sure your unit is sturdy.
- Do NOT use harsh chemicals or abrasive cleaners on this item.
- Never push, pull, or drag your furniture.



Board Identification

Not actual size

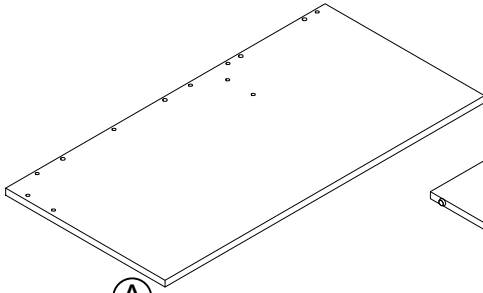

(A)
TOP
Qty:1

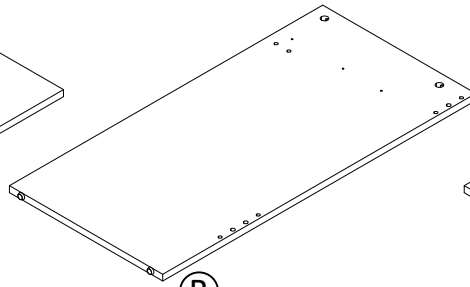

(B)
LEFT SIDE PANEL
Qty:1

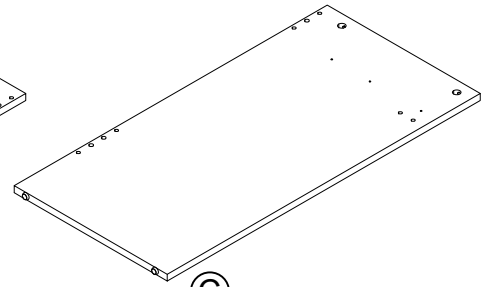

(C)
RIGHT SIDE PANEL
Qty:1

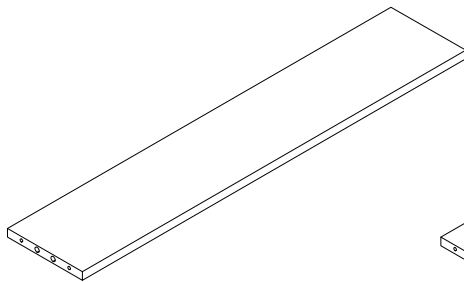

(D)
LOWER BACK PANEL
Qty:1

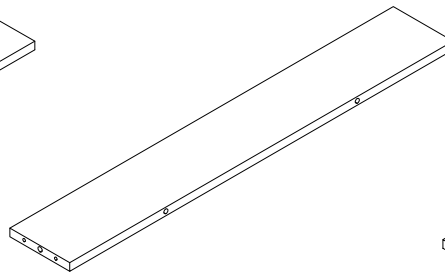

(E)
UPPER BACK PANEL
Qty:1

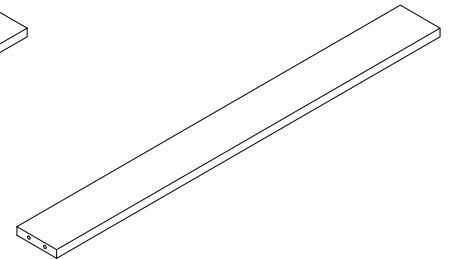

(F)
FRONT SLAT PANEL
Qty:1

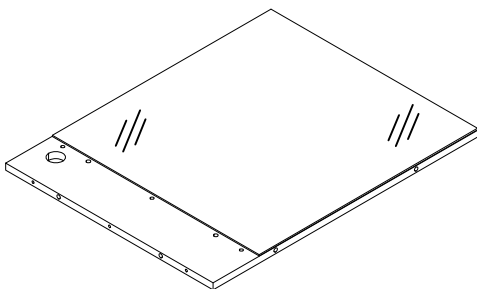

(G)
DRESSING MIRROR
Qty:1

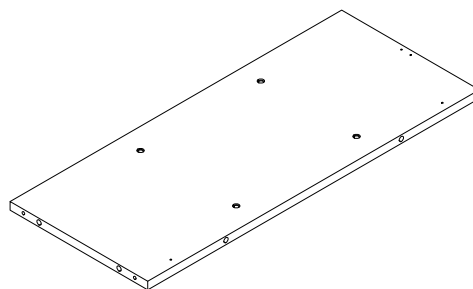

(H)
HUTCH BACK PANEL
Qty:1

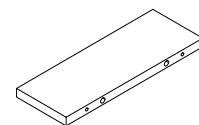

(I)
HUTCH RIGHT FIXED SHELF
Qty:2

Board Identification

Not actual size

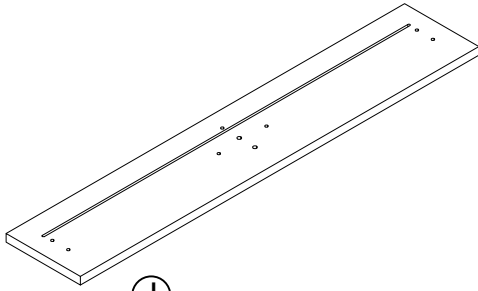

ⓐ

DRAWER FRONT
Qty:1

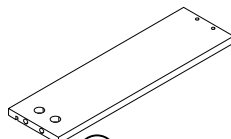

ⓑ

DRAWER LEFT PANEL
Qty:1

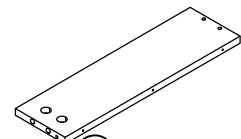

ⓒ

DRAWER RIGHT PANEL
Qty:1

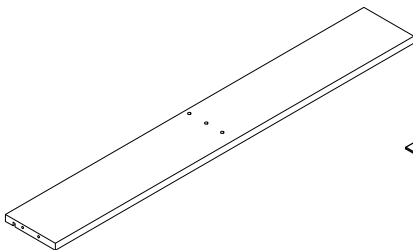

ⓓ

DRAWER BACK PANEL
Qty:1

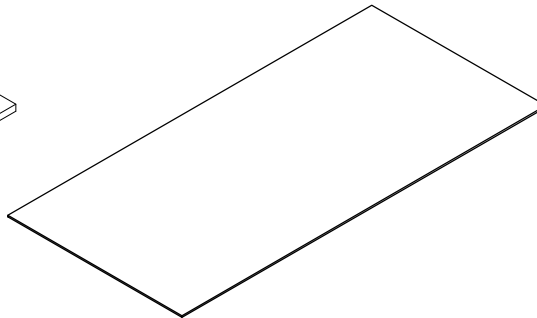

ⓔ

DRAWER BOTTOM
Qty:1

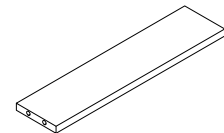

ⓕ

DRAWER MIDDLE PARTIION
Qty:1

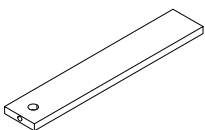

ⓖ

DRAWER SUPPORT RAIL
Qty:1

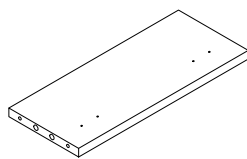

ⓗ

STOOL BACK APRON
Qty:1

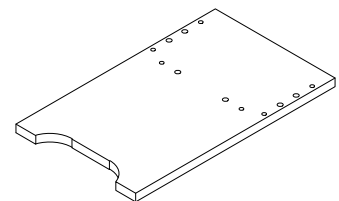

ⓘ

STOOL SIDE PANEL
Qty:2

Board Identification

Not actual size

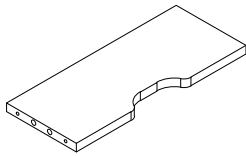

Ⓢ

STOOL FRONT APRON
Qty:1

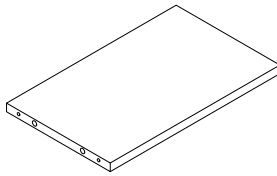

Ⓣ

STOOL BOTTOM BOARD
Qty:1

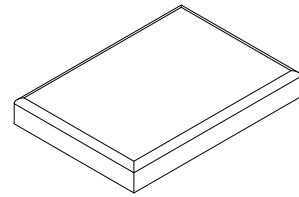

Ⓤ

SPONGE CUSHION
Qty:1

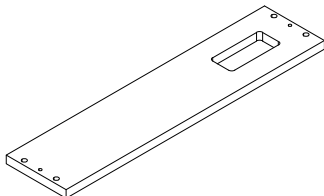

Ⓥ

HOTCH LEFT FIXED SHELF
Qty:1

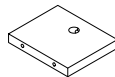

Ⓦ

HOTCH SIDE PANEL
Qty:2

Board Identification

Not actual size

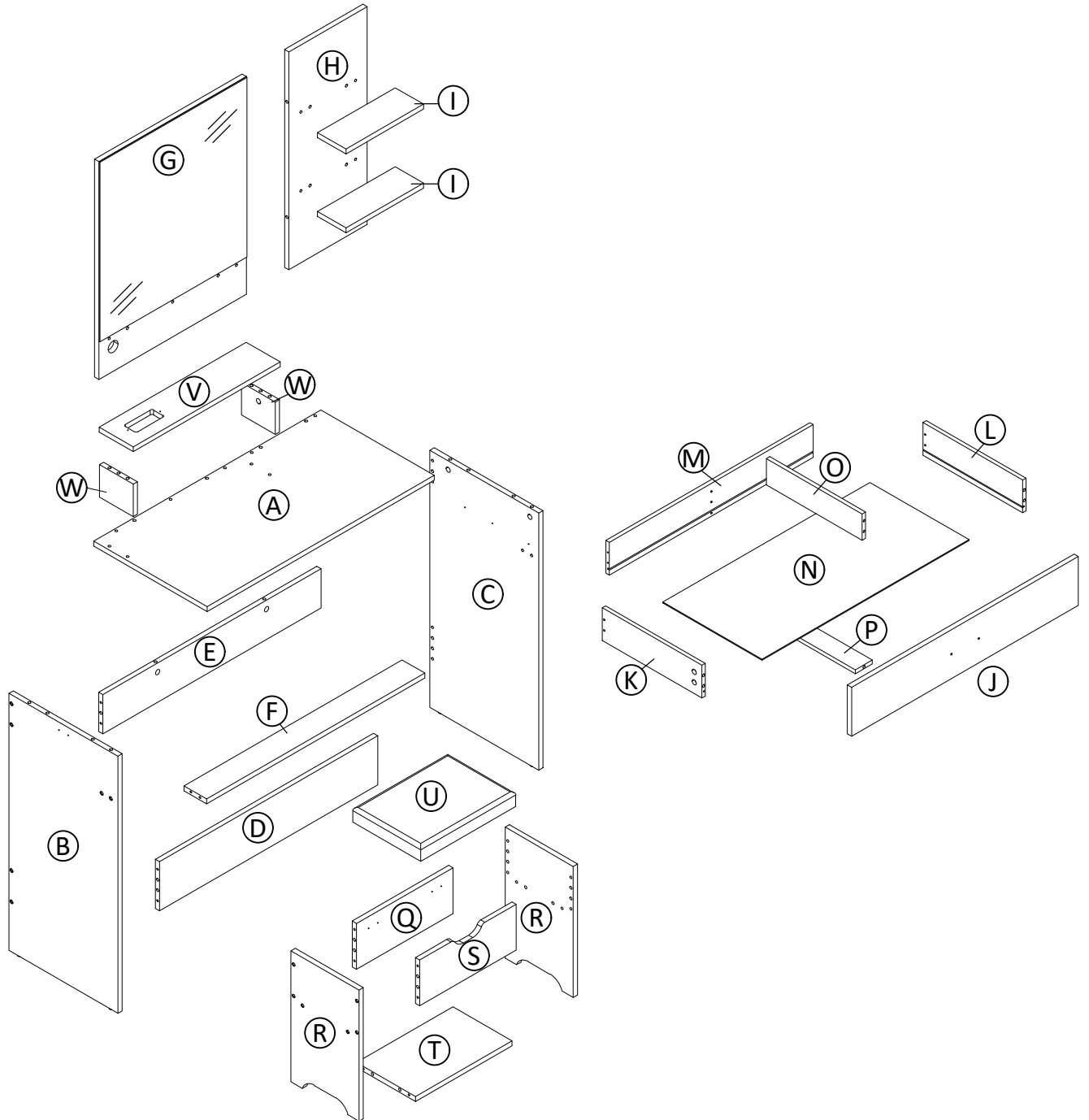

Part List

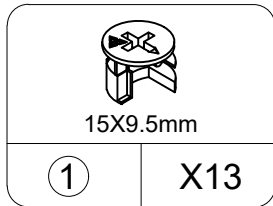

CAM LOCK
spare:2

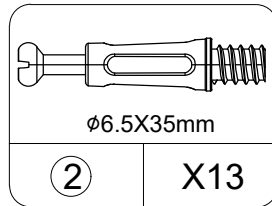

CAM BOLT
spare:2

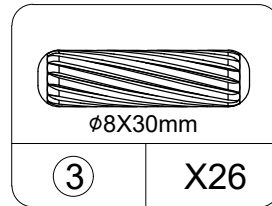

WOOD DOWEL
spare:3

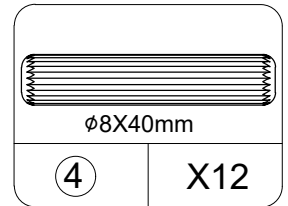

WOOD DOWEL
spare:2

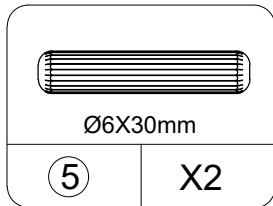

WOOD DOWEL
spare:1

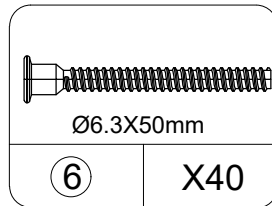

SCREW
spare:3

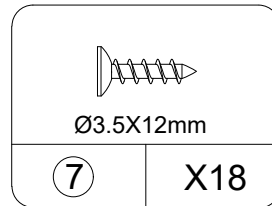

SCREW
spare:2

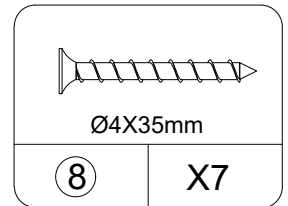

SCREW
spare:1

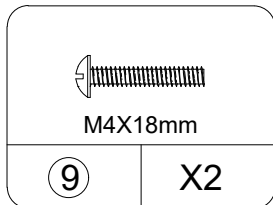

SCREW
spare:1

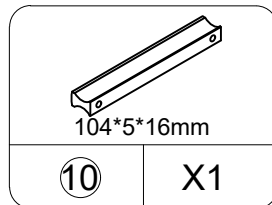

HANDLE

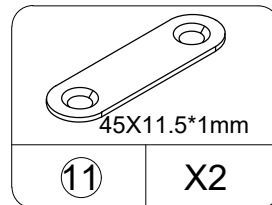

METAL PLATE

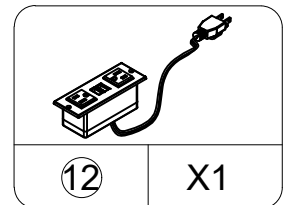

PLUG BOARD

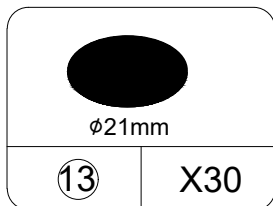

PERFECT STICKERS
spare:3

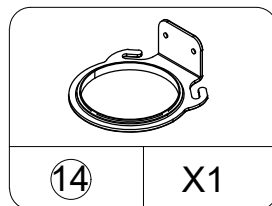

HAIR DRYER RACK

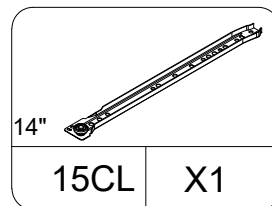

LEFT CABINET MEMBER

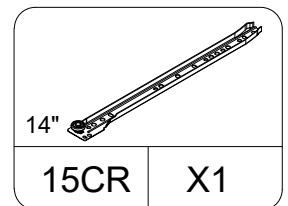

RIGHT CABINET MEMBER

Part List

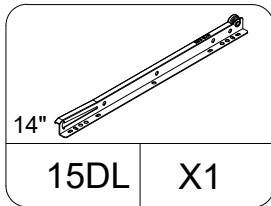

LEFT DRAWER RUNNER

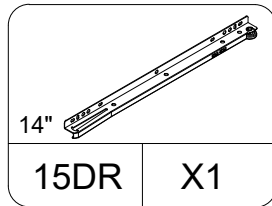

RIGHT DRAWER RUNNER

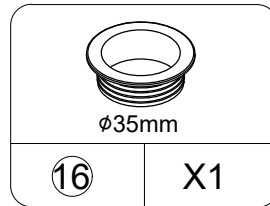

GROMMET

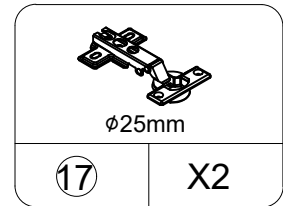

HINGE

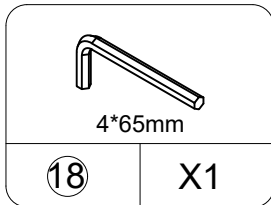

HEX KEY

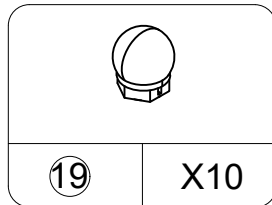

LIGHT BULB

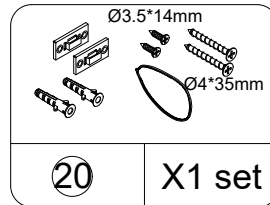

ANTI-TIPPING HARDWARE

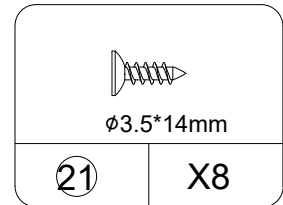

SCREW
spare:1

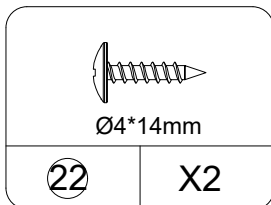

SCREW
spare:1

Cam Lock Fastening System

Insert the cam bolt into the hole first, then insert the cam lock and lock it.

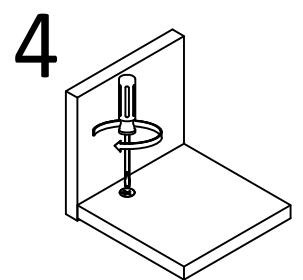
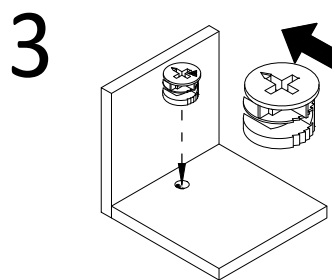
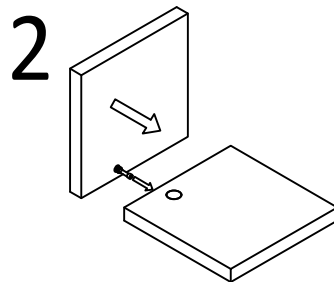
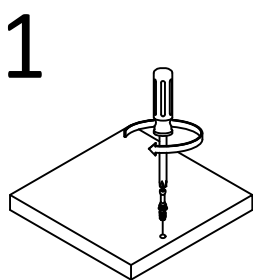

The opening must point toward the edge of the board

STEP 1

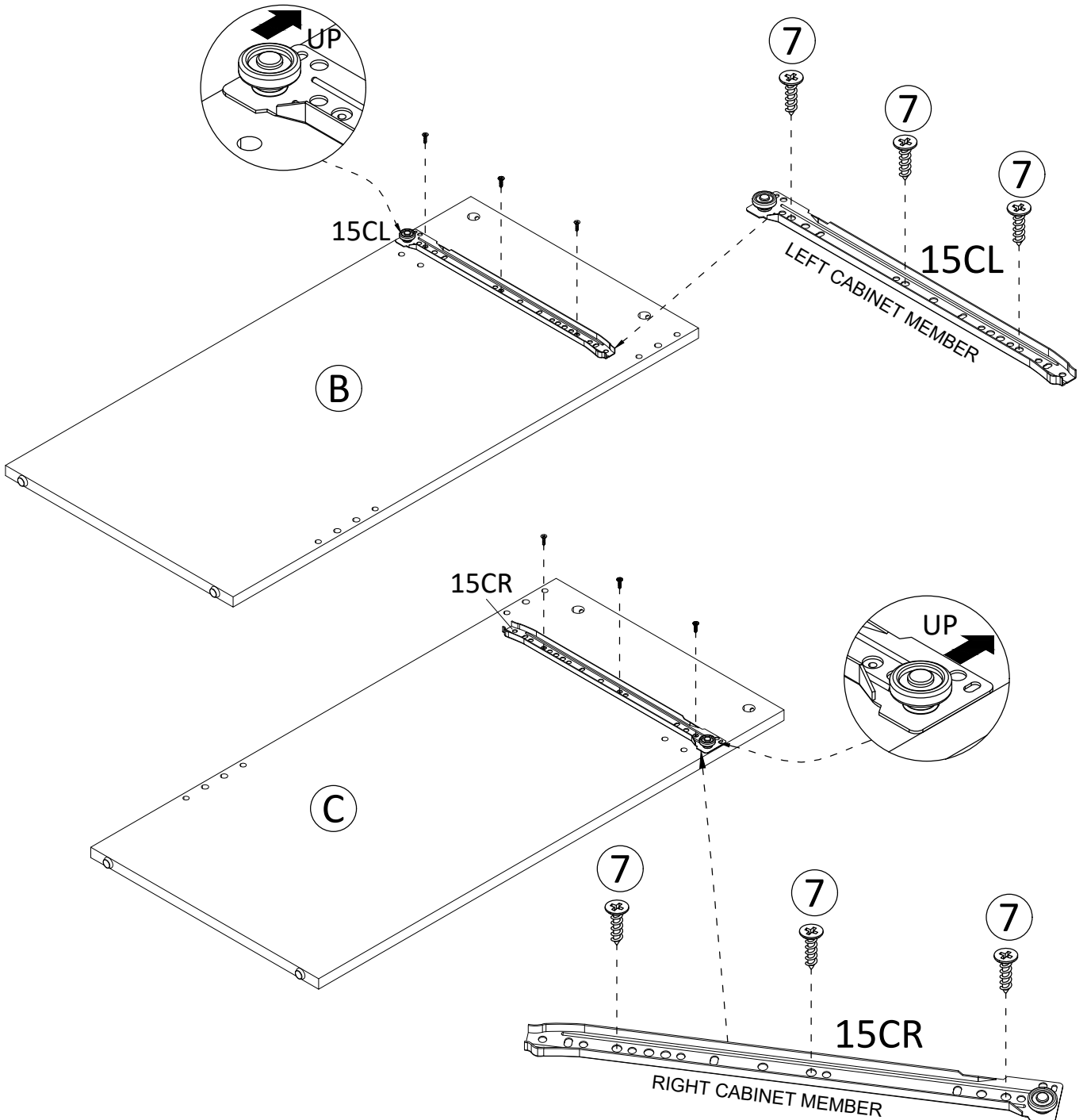
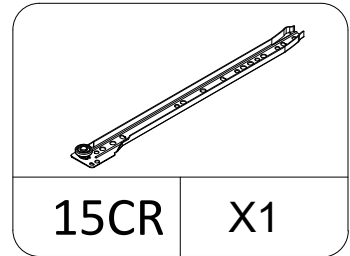
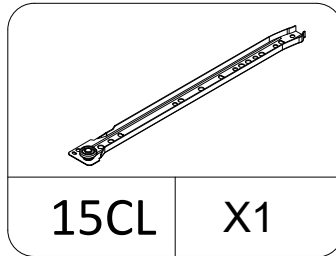
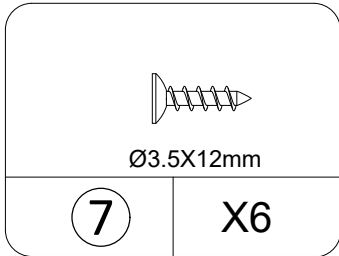
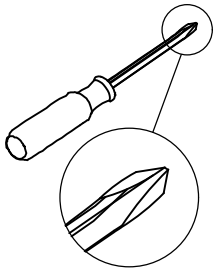

STEP2

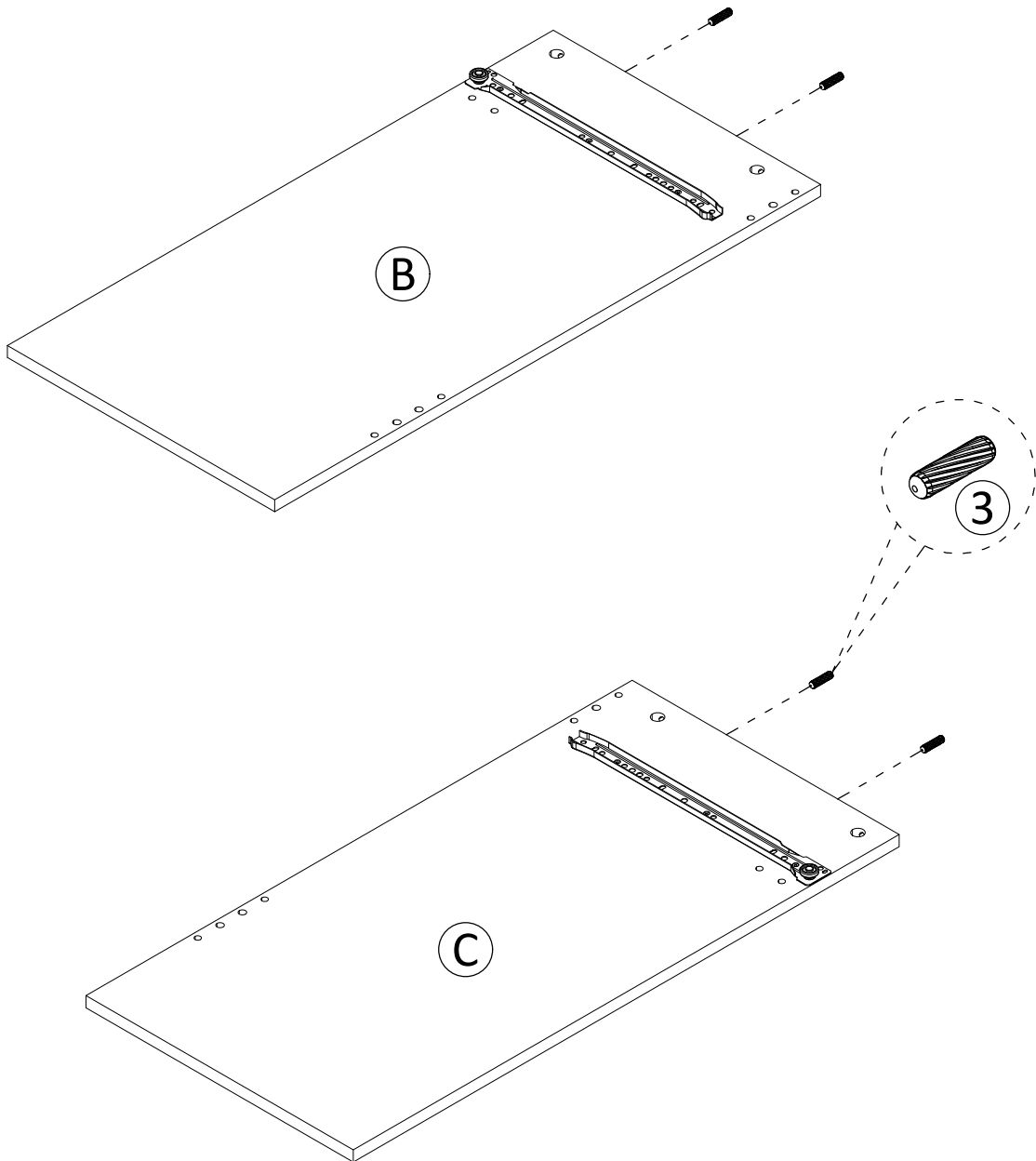
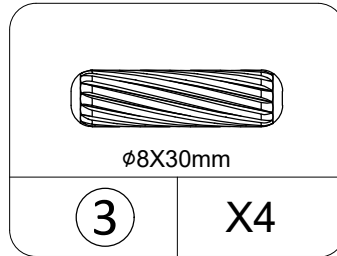

STEP3

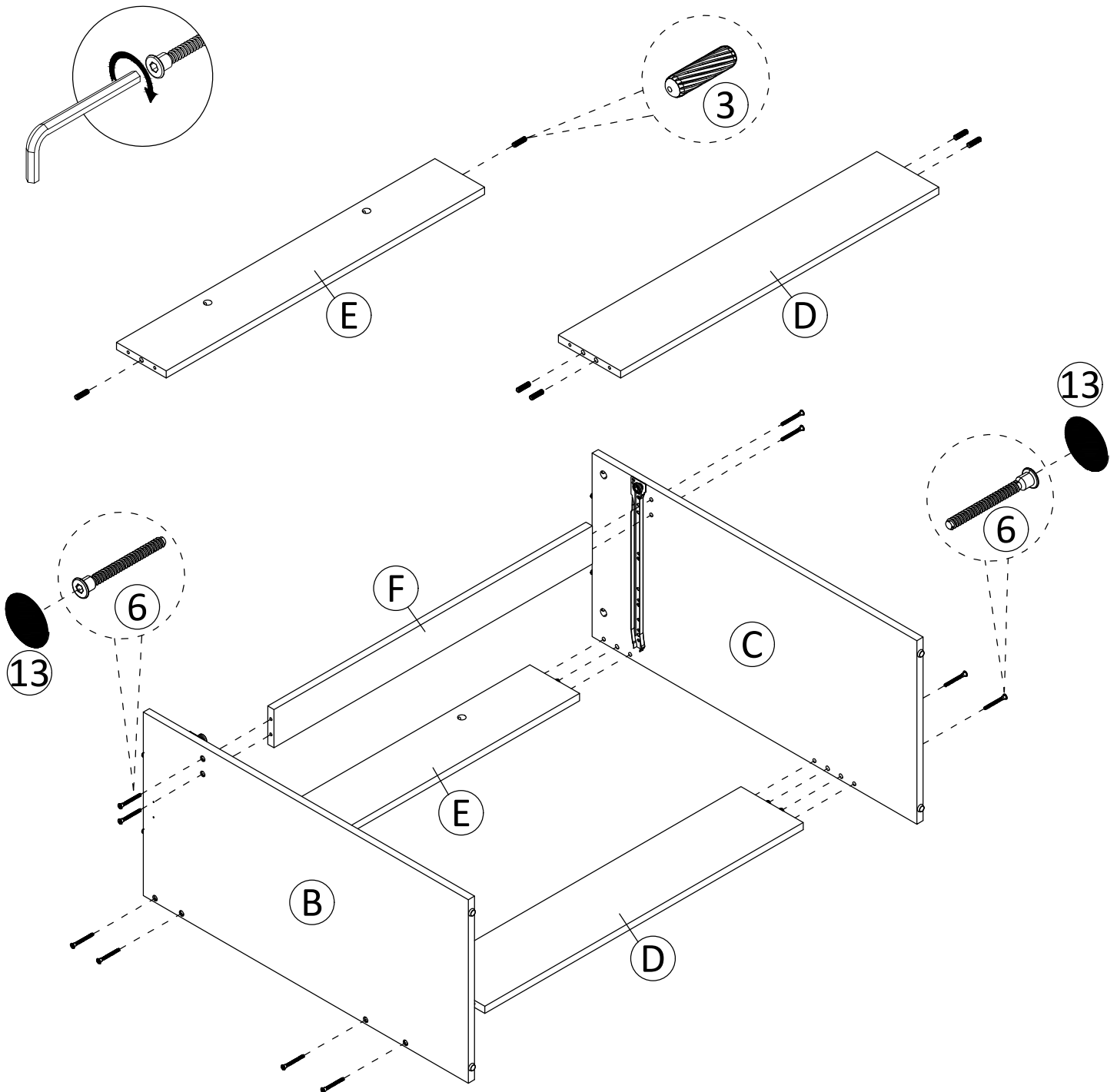
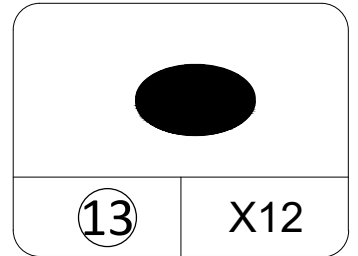
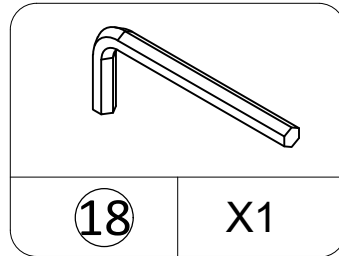
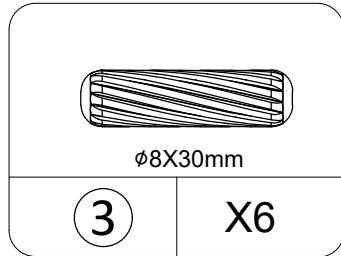
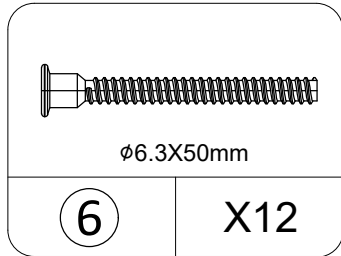

STEP 4

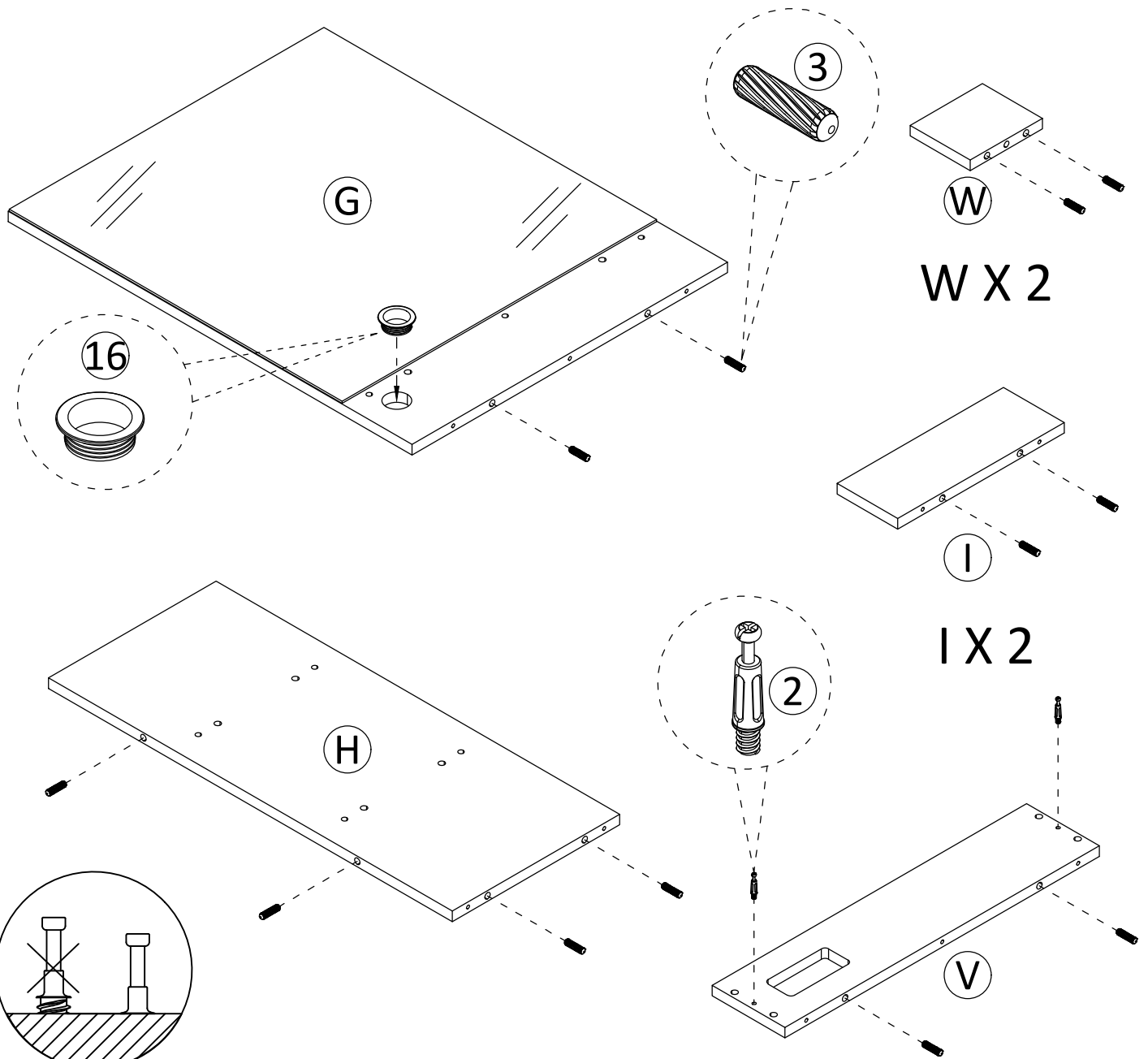
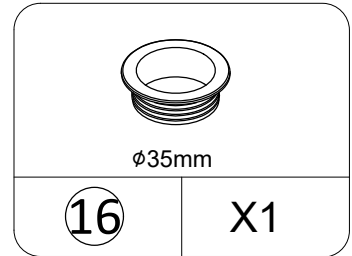
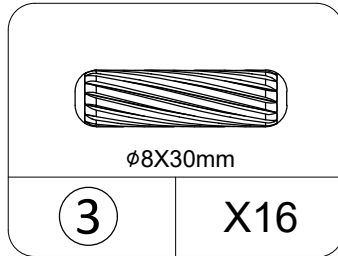
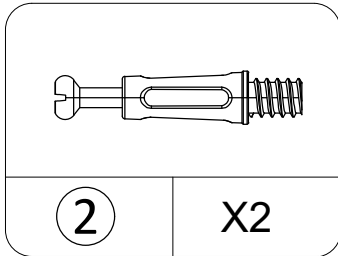
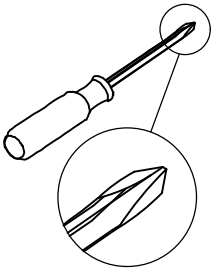

STEP 6

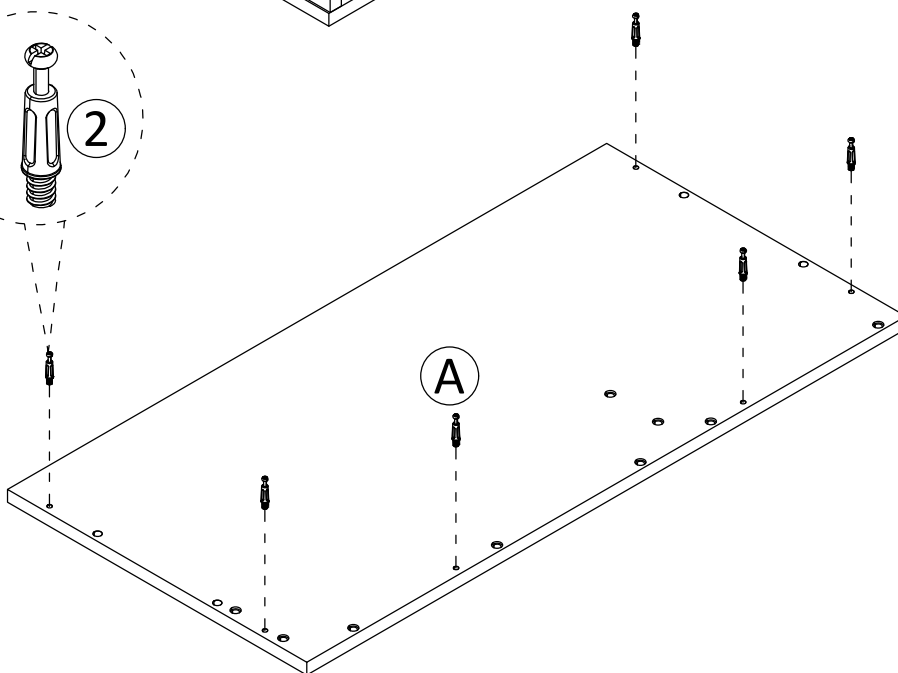
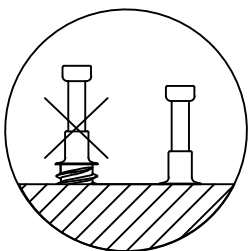
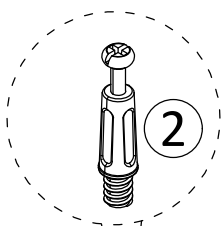
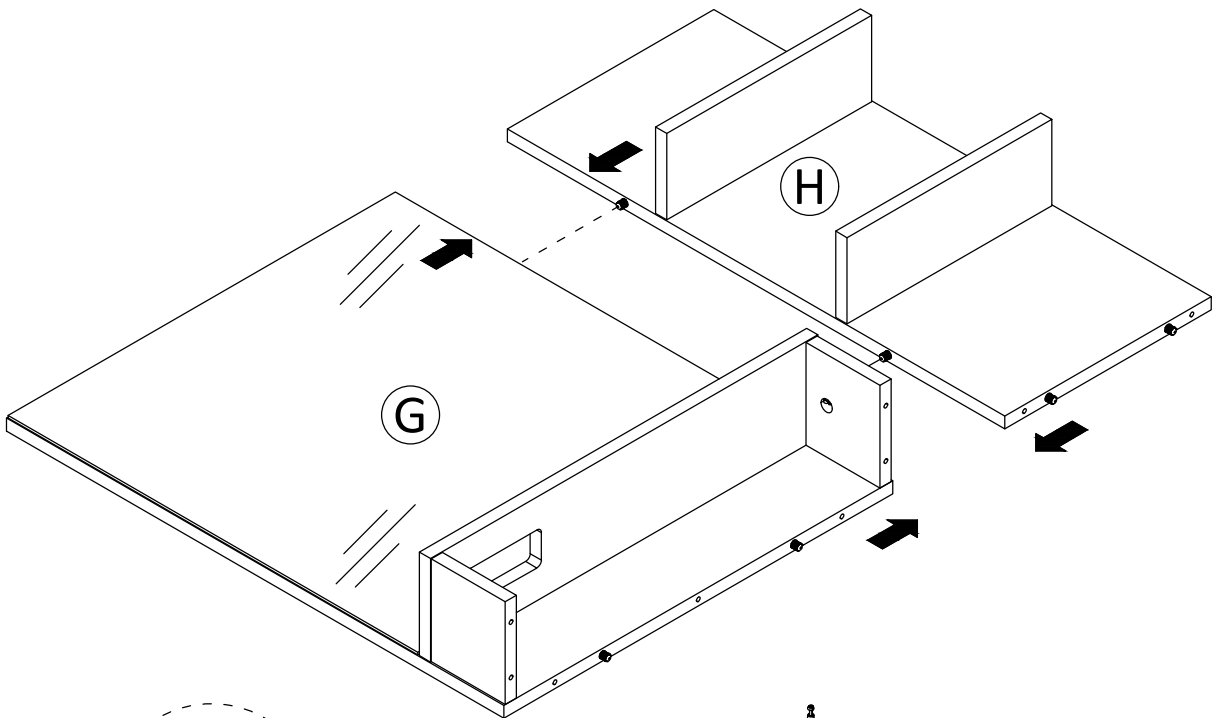
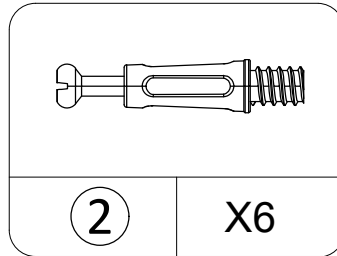
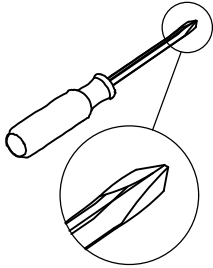

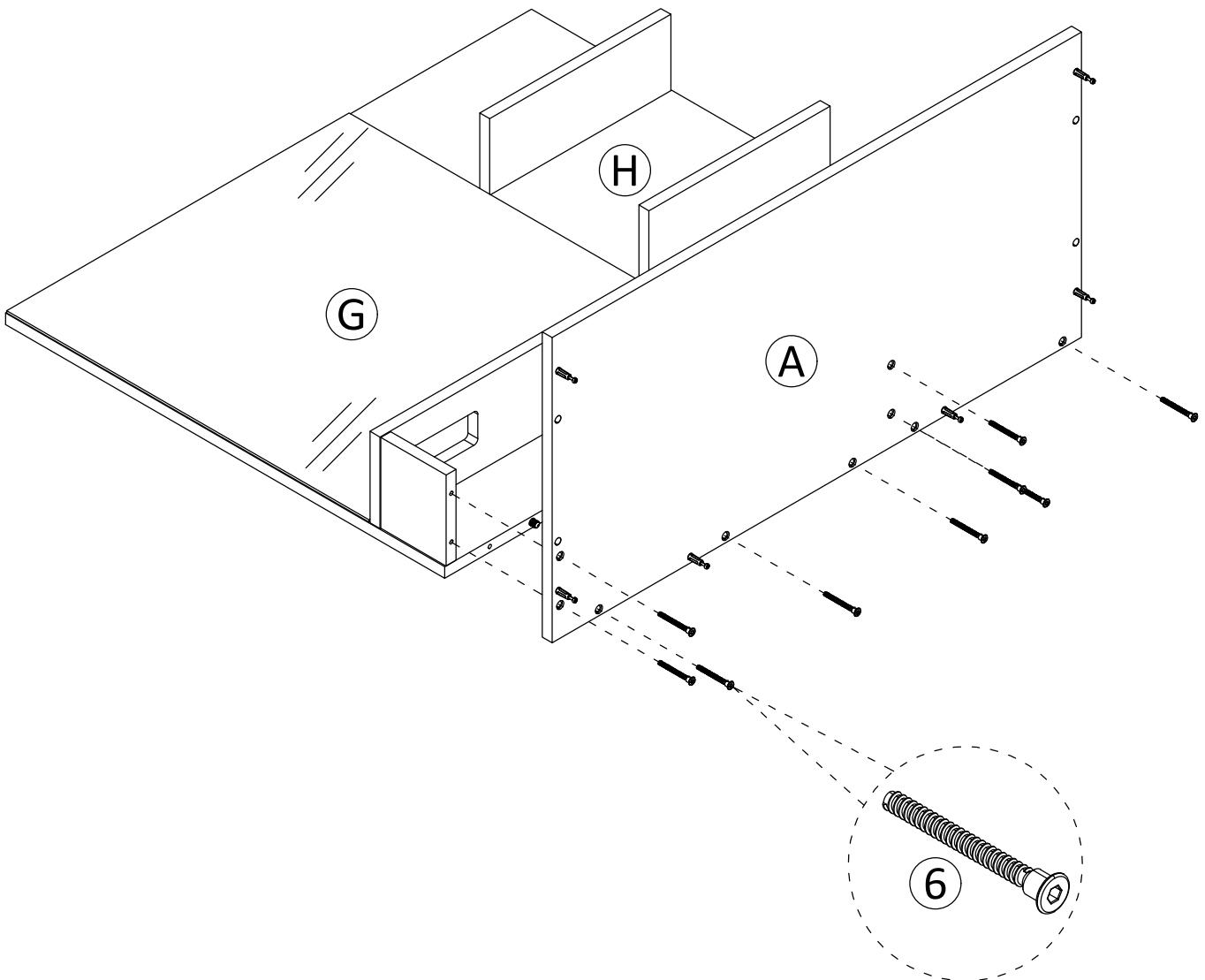
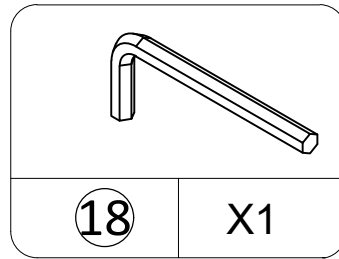
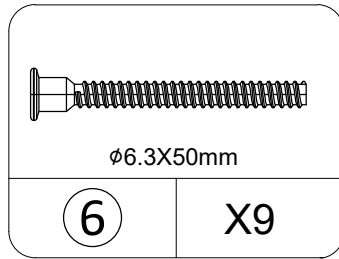
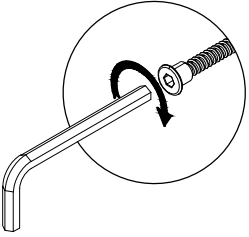

STEP 7

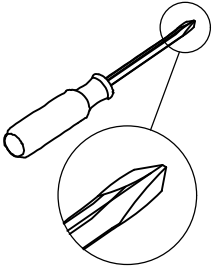

STEP 8



 Ø15X9.5mm	
1	X6

 Ø4X14mm	
22	X2

	
14	X1

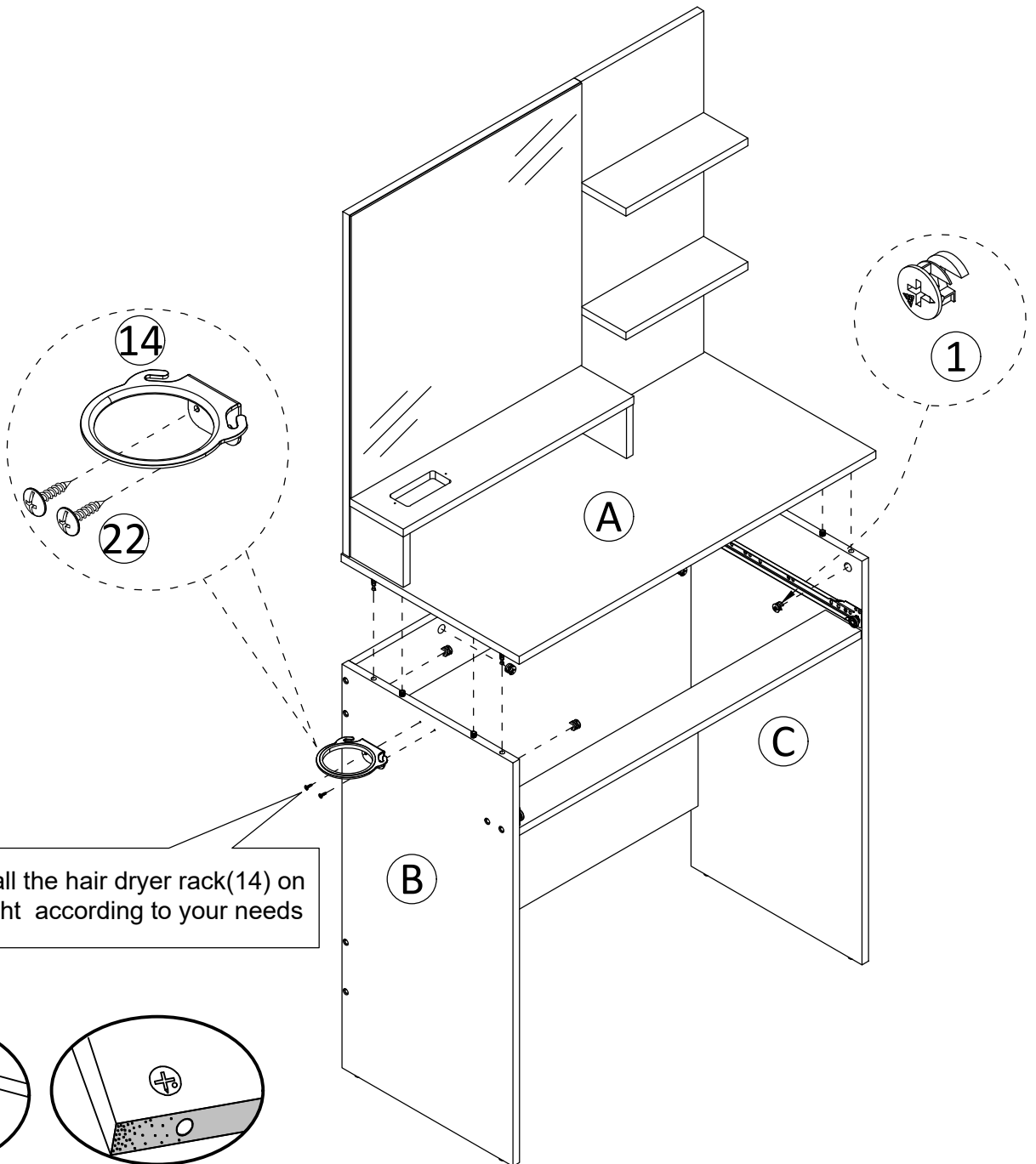

You can install the hair dryer rack(14) on the left or right according to your needs

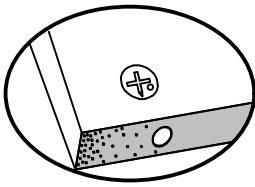
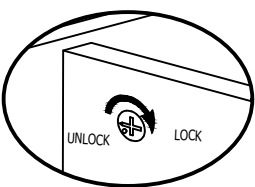

Proper orientation of CAM LOCK

STEP 9

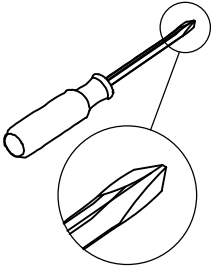

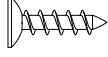
 Ø3.5X12mm	
7	X4

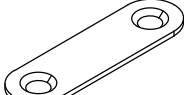
 45X11.5*1mm	
11	X2

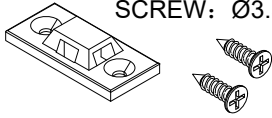
 SCREW: Ø3.5*14	
20	X1 set

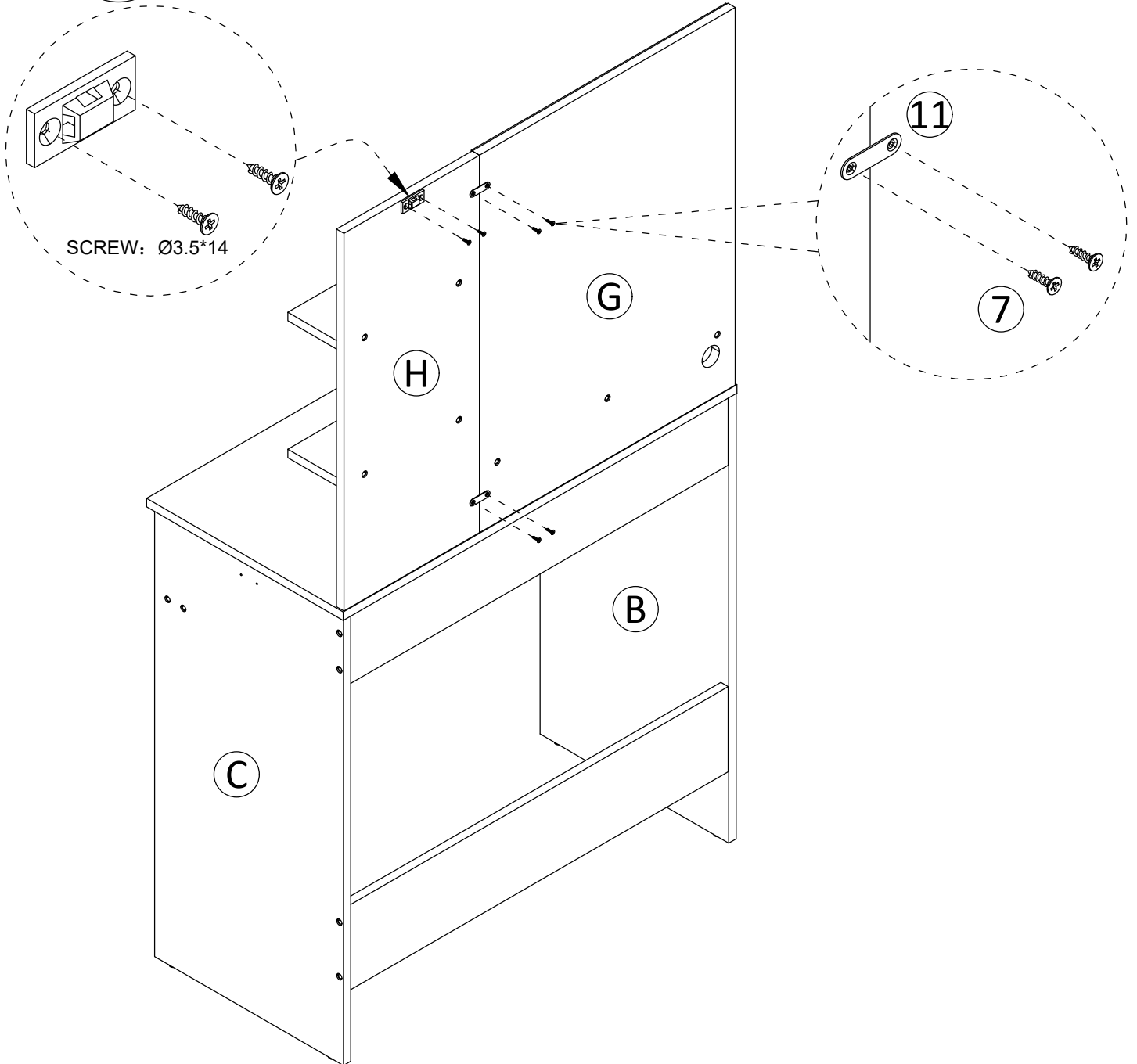

STEP 10

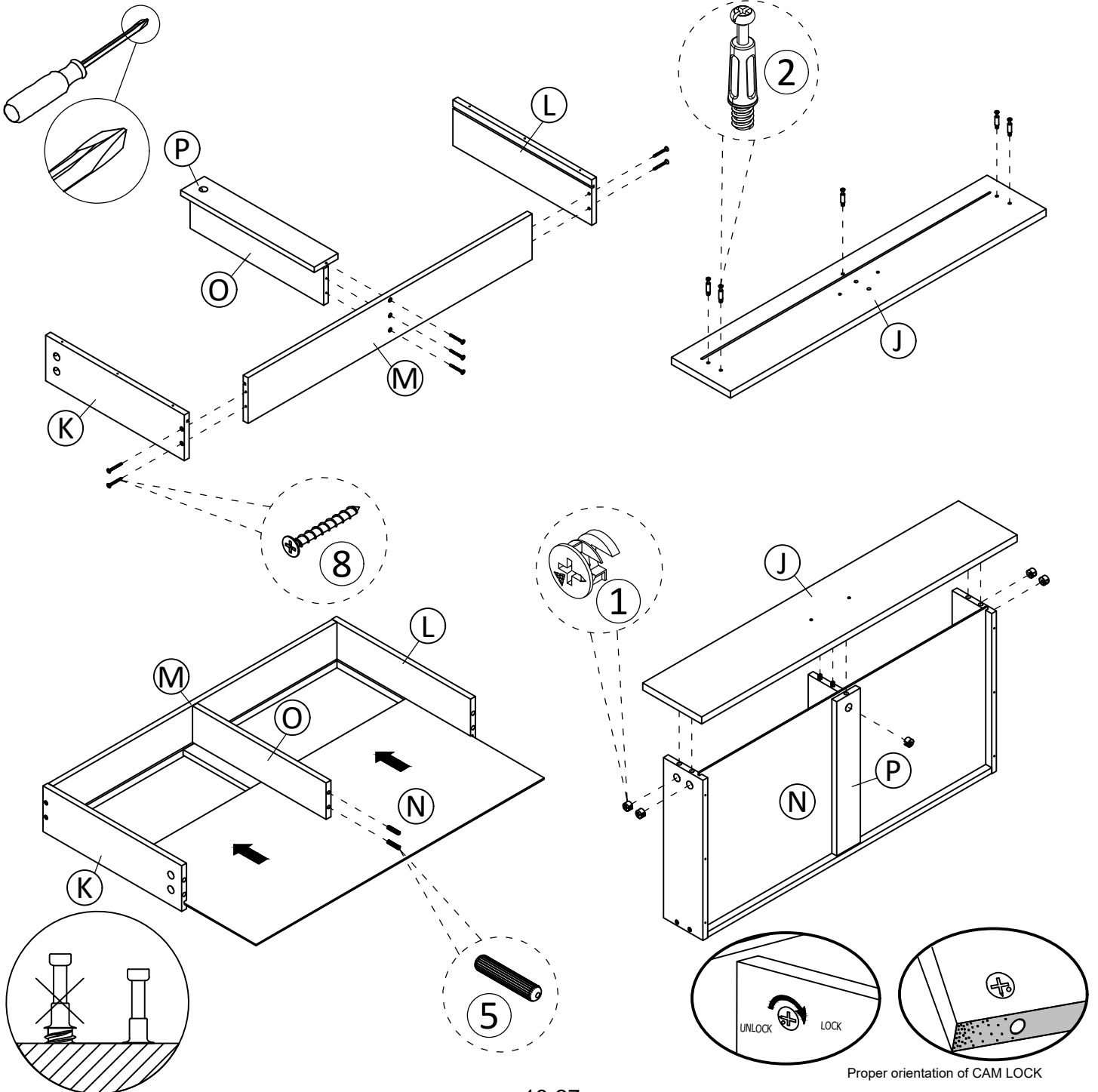
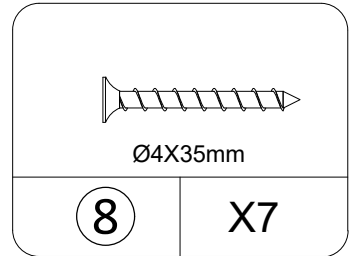
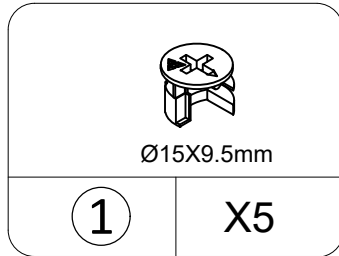
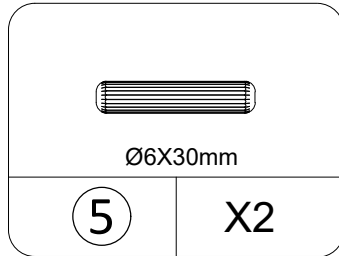
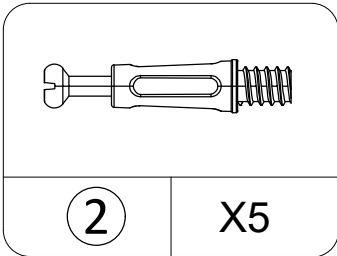

STEP 11

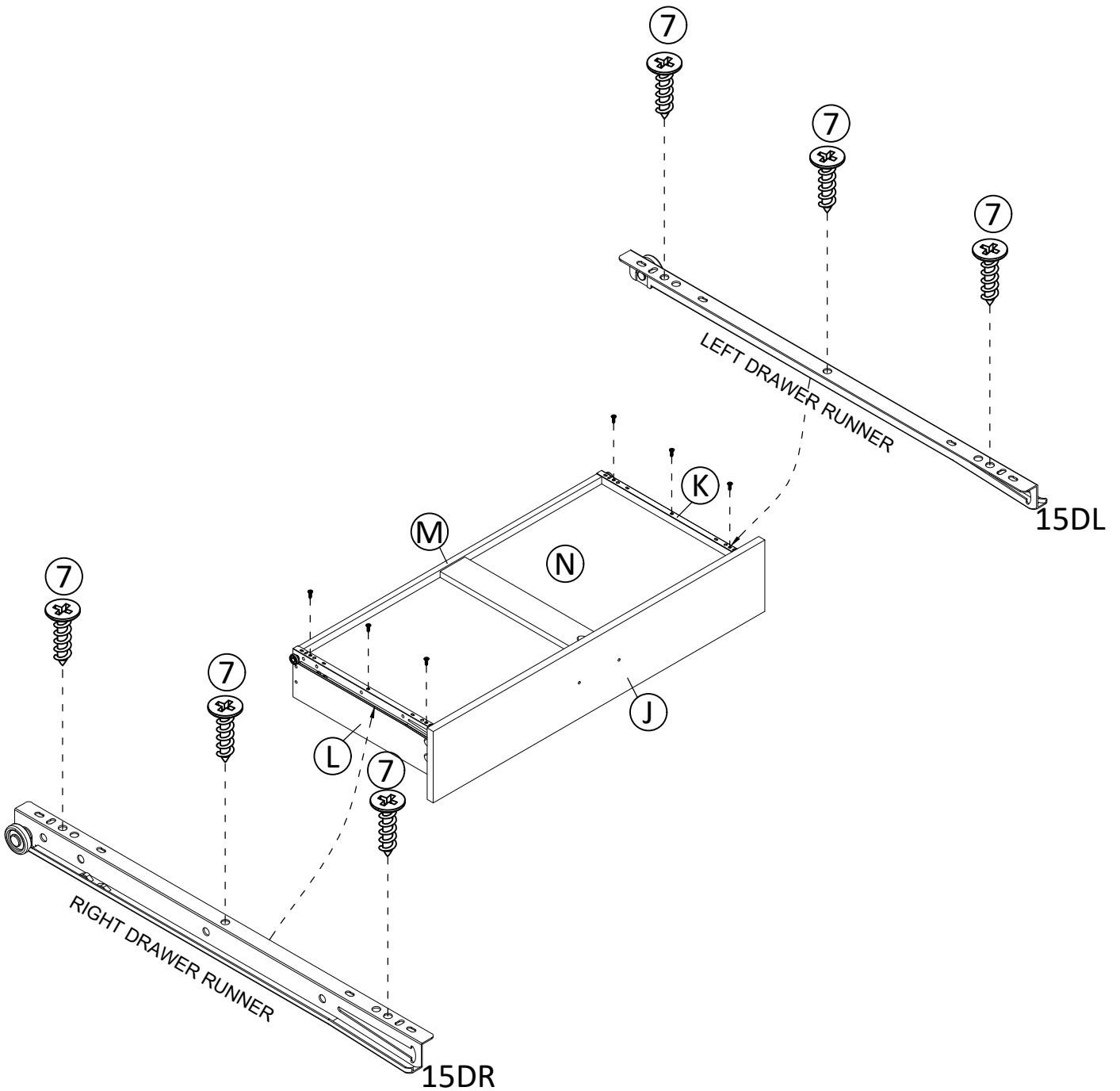
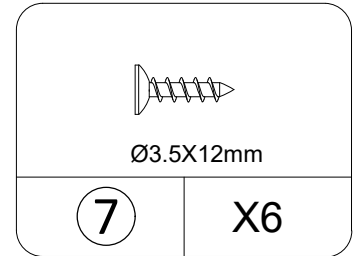
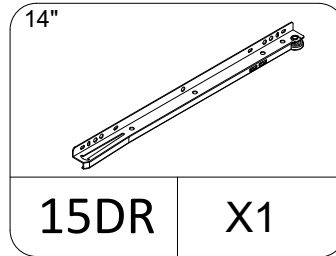
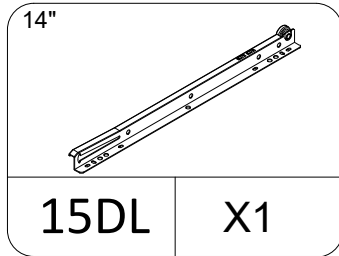
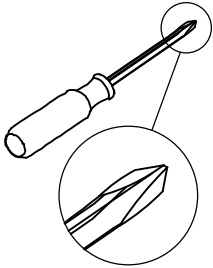

STEP 12



M4X18mm

9	X2
---	----



104*5*16mm

10	X1
----	----

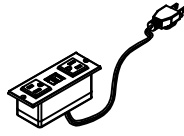

12	X1
----	----

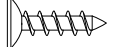

Ø3.5X12mm

7	X2
---	----



13	X4
----	----

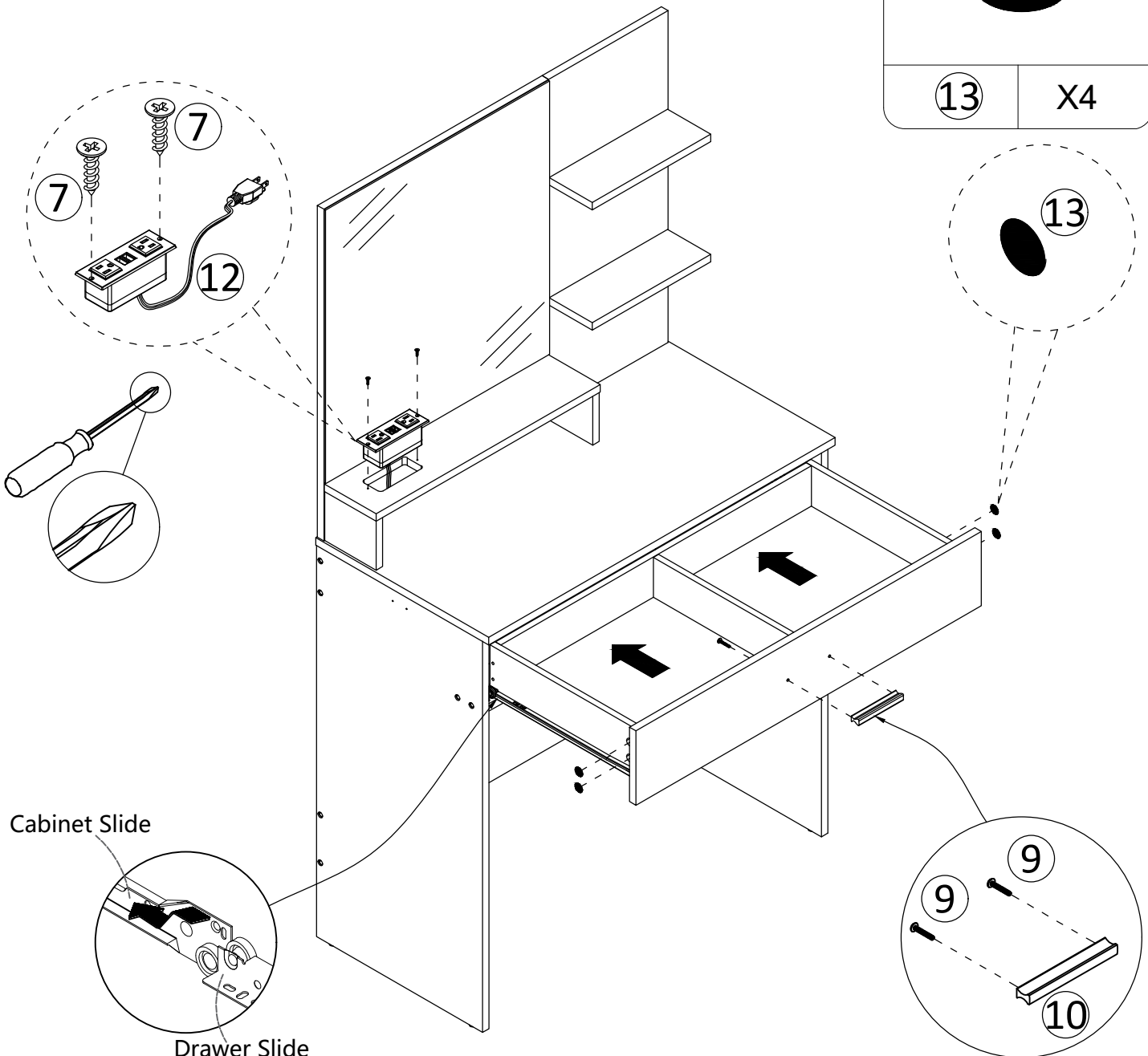

STEP13

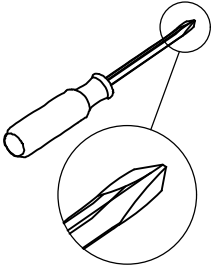

 Ø8X40mm	
4	X12

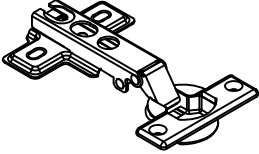
	
17	X2

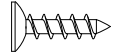
 Ø3.5X14mm	
21	X4

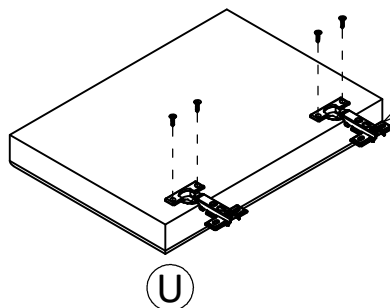
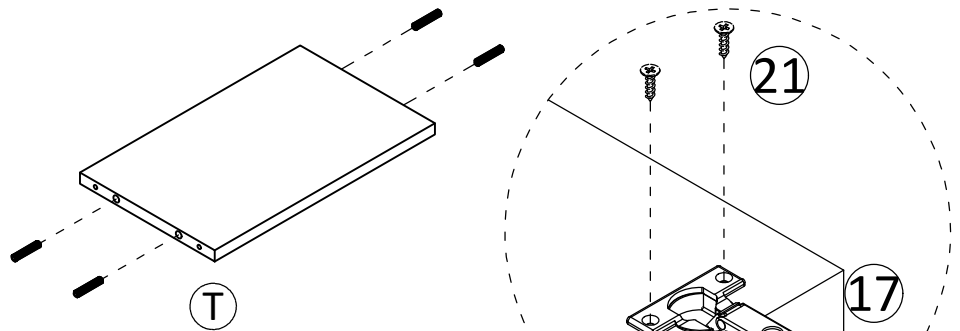
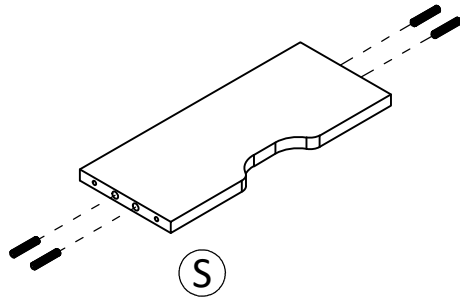
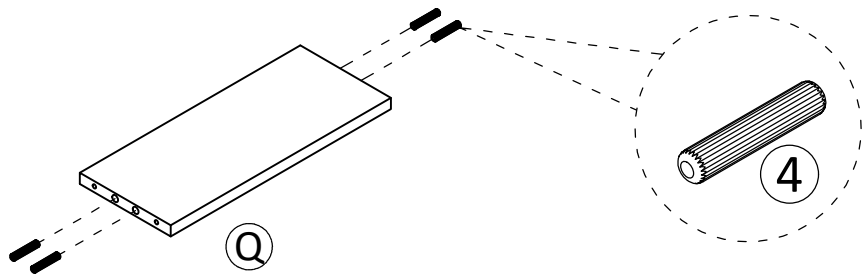

STEP14

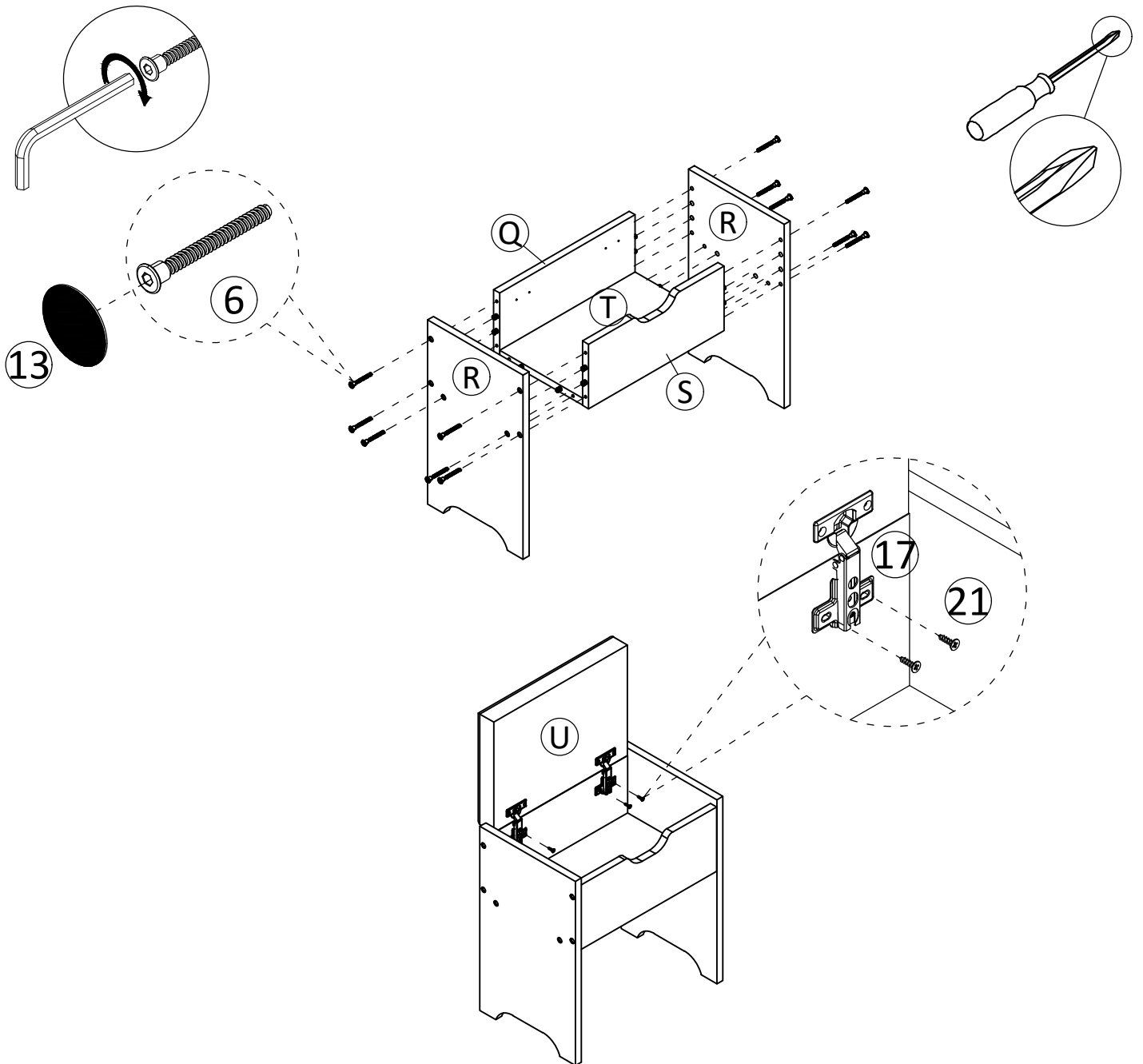
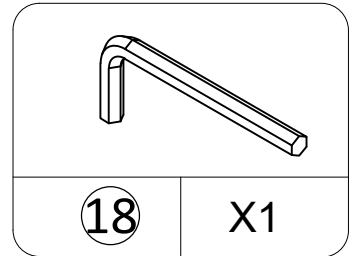
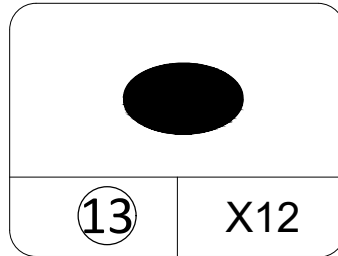
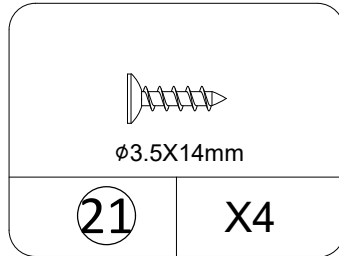
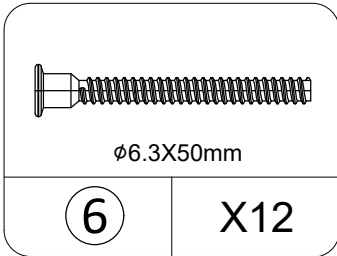

STEP15

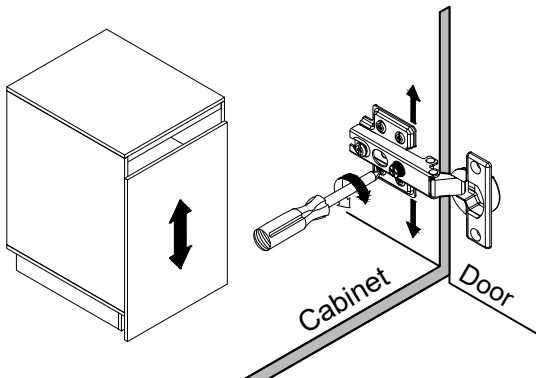
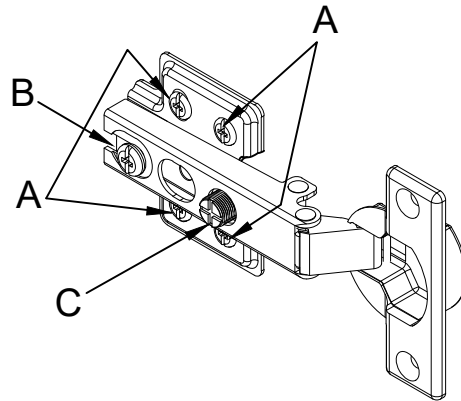

To adjust the vertical height.

Loosen the four screws "A" on both hinges. Two of them are usually in slotted holes which allows you to adjust up or down by a few mm. Then tighten back up.

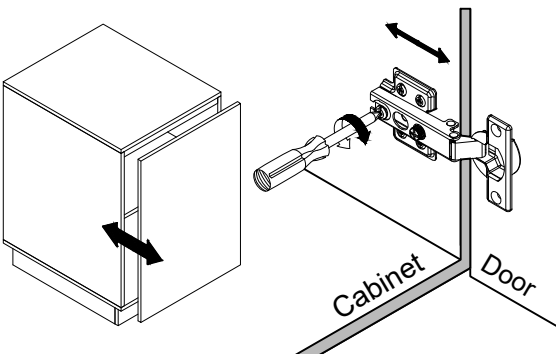

To adjust depth.

Loosen screw "B" and adjust door, if the door can not be adjusted, please loosen screw "C", then try again. Tighten screw "B" and "C".

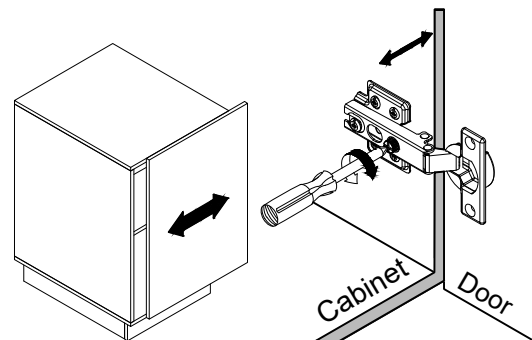

To adjust side ways.

Turning the screw "C" on BOTH hinges on each door.

STEP16

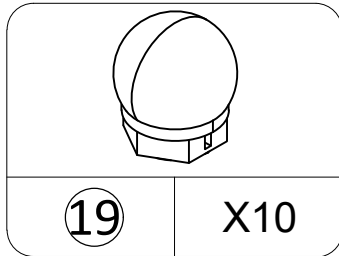

For specific installation and debugging,
please read the last two pages

USB PLUG

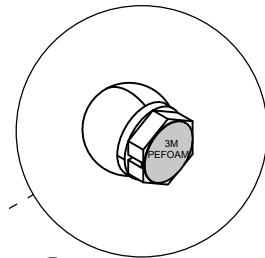
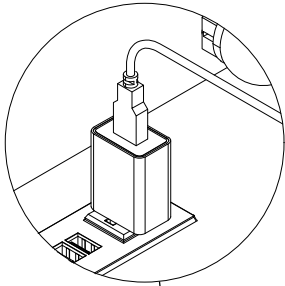

ABS lamp holder

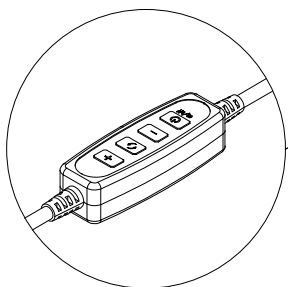
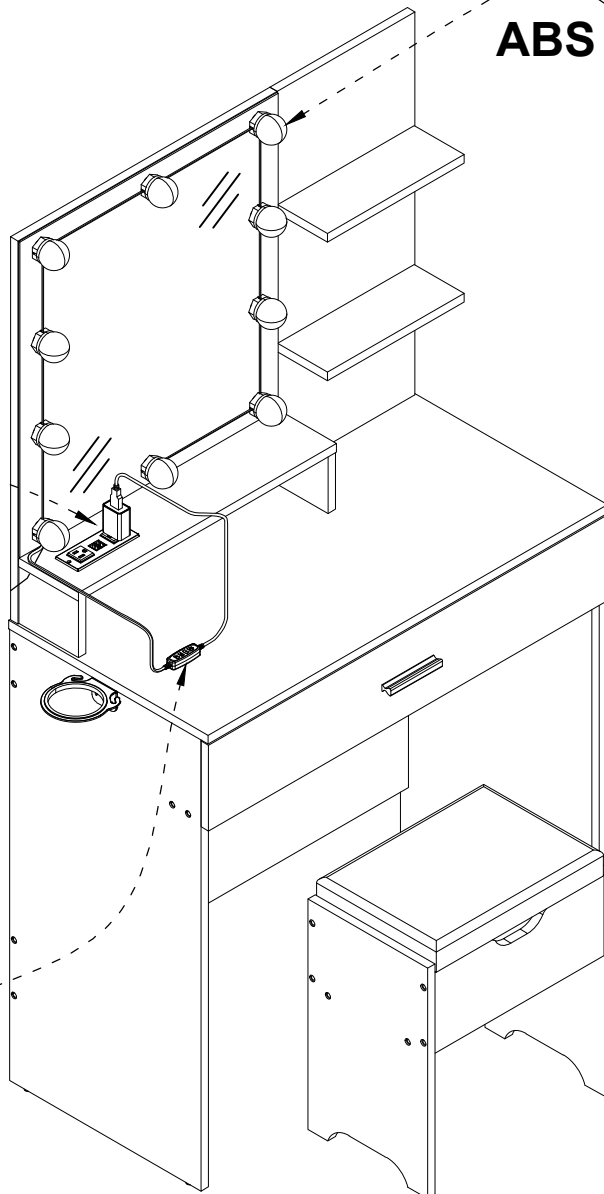

Switch regulator

STEP 17

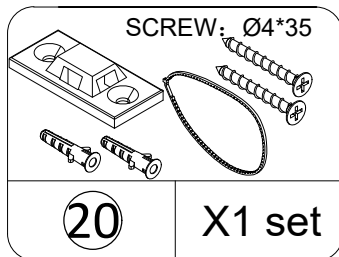

We have included a set of tipping restraint hardware for this unit. You must install this hardware to prevent accidents or injuries that can result from the unit falling. When properly installed, this restraint can provide protection against the unexpected tipping of the unit due to small tremors, bumps or climbing. We strongly recommend mounting this hardware to a wall stud and your unit.

NOTE:The tipping restraint hardware included is for wooden stud wall construction. It must be attached to a wall stud. Depending upon your wall construction different anchor hardware maybe required. Please contact your local hardware store for assistance. Young children can be seriously injured by tipping furniture. You must install the tipping restraint hardware with the unit to prevent the unit from tipping, causing any accidents or damage. The tipping restraints are intended only as a deterrent and are not a substitute for proper adult supervision. The tipping restraints are not earthquake restraints. If you wish to add the extra security of earthquake restraints, they must be purchased and installed separately.



Install the tipping restraint hardware

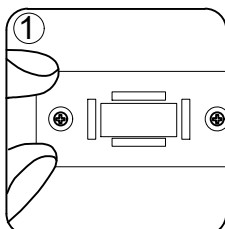

1. make mark on the wall

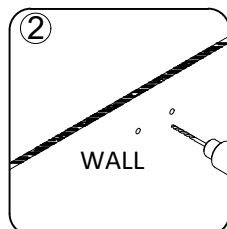

2. drill two Ø6 holes on the wall

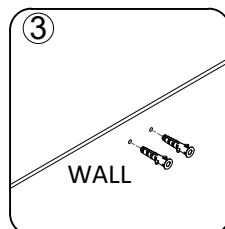

3. put two anchors in the holes

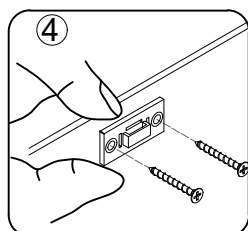

4. fix the device on the wall by the long screws

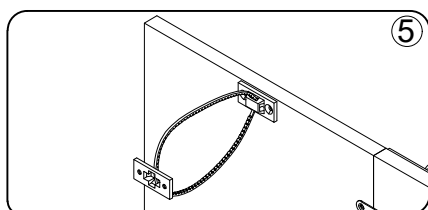

5. Push the cabinet close to the wall so that the two bases are close to each other, and then put on nylon tie to tighten it.

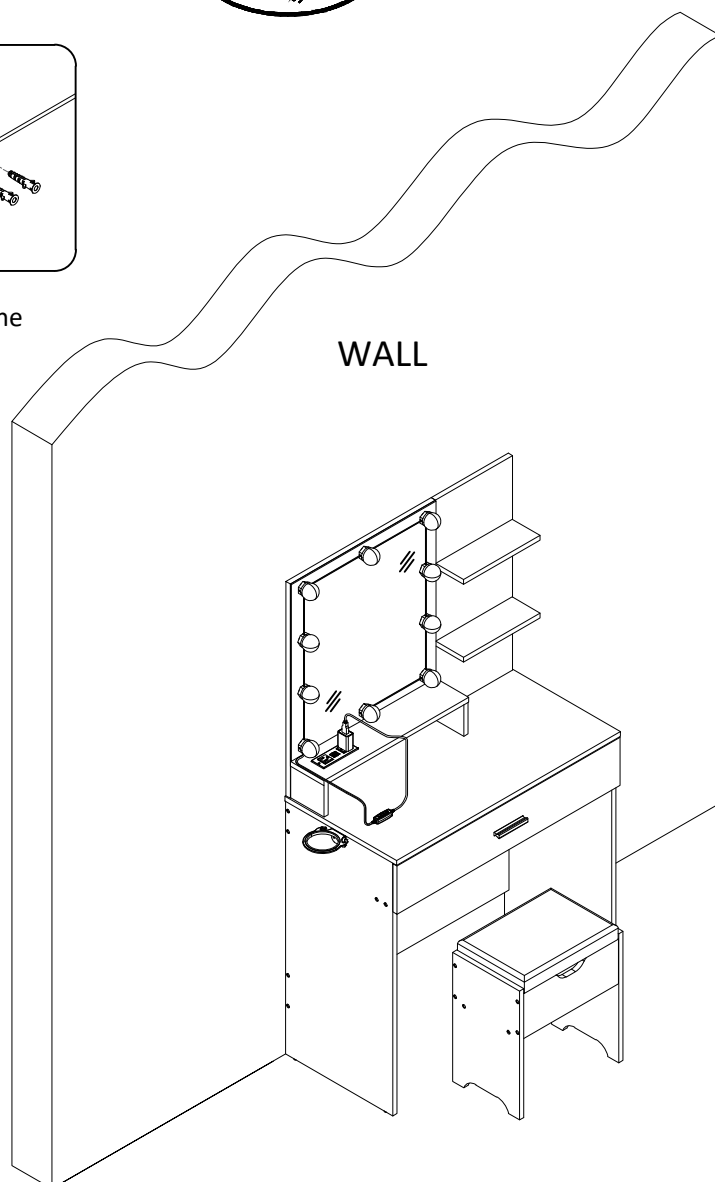

CONTINUED

Thank you for purchasing our company's DIY makeup mirror fill Light products, this product supports DIY own home mirror, instantly make their own mirror into a modern fashion makeup with LED Fill mirror. Even more interesting is that you can adjust the color temperature by yourself!

Product Features:

1. The standard USB power supply, safety voltage.
2. PC soft mask, don't stab the eyes.
3. All transparent lines, beautiful and stylish.
4. Multilevel luminance adjustable, beauty skin and beauty face.
5. The color temperature is adjustable with the buttons.
6. By rotating the bulbs, the excess connecting wire can be hidden in the bottom shell - make the installation more simple and beautiful.

Product parameters:

Product Name: Vanity Mirror Lights.

Bulb Size: 50 X 50 X 55 mm.

Power Supply: Standard USB 5V 2A or above.

LED colour temperature : 3000K/4500K/6500K

Power: a single lamp maximum power is 0.8W.

Material: ABS lamp-holder and PC lampshade.

Wisdom in design:

Rotate the bulbs clockwise or anticlockwise, the ball bubble spacing becomes shorter, the connection line shrinks and hides in the ball bubble bottom cover. Simple and beautiful installation, use more comfortable.

Rest assured dressing:

USB 5V low voltage power supply, safe! Multilevel luminance adjustable, suitable for different dressing needs.

Three kinds of color temperature can be adjusted: Warm White, Natural White and Pure White.

Vanity Mirror Lights

The color temperature is adjustable

Instructions

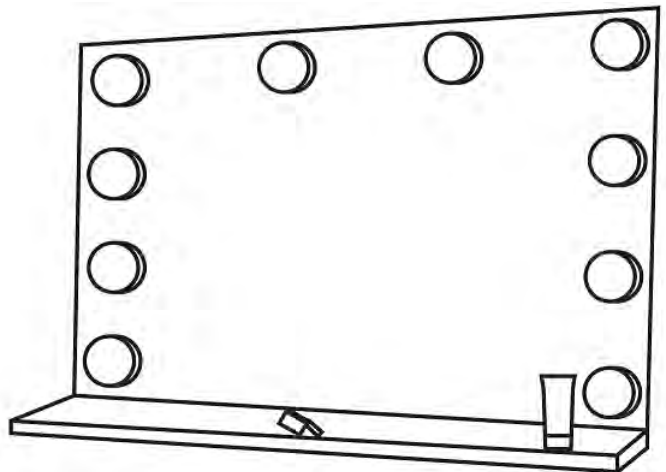

See Yourself Better!!!

Wisdom in design, Enjoy your life!

CONTINUED

Use the installation details see inside pages.

Functional Description:

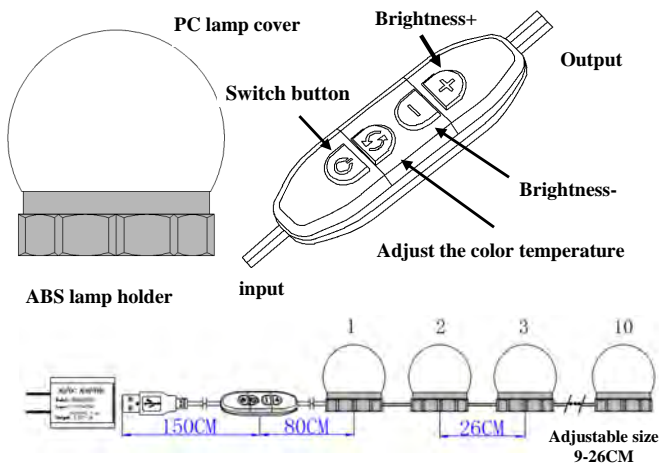

Application notes:

1. It is recommended to choose 2A or above USB power adapter, mobile phone charger and other standard USB mobile power can be use.
2. The product uses double-side adhesive paste installation of the bonding surface must be clean, dry, smooth, can not have rust and oil.
3. The wire can be adjustable through the winding between the base slot, and the bulb spacing can be adjusted between 9-26CM.

Reminded: When the bulb is pasted, please press the product for about 30 seconds, it takes 24 hours to achieve the best adhesive strength.

See Yourself Better!!!

Install reference diagram:

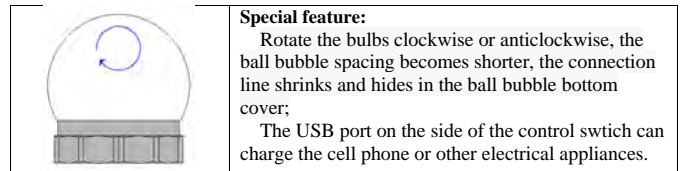
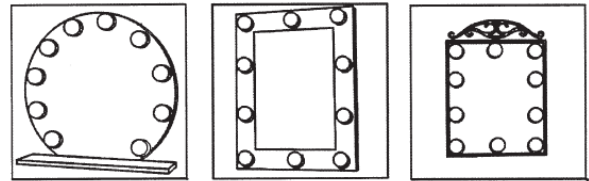

Installation steps:

1. Cosmetic mirror or be installed surface treatment : should be sticky surface should be dry, clean, and no rust, oxidation, grease, dust and other pollutants.
2. According to the design of the number of mirrors and bulbs ,each bulb installation location, note the lamp spacing of up to 26 CM, the minimum spacing of about 9 CM.
3. Remove the product to determine the power and control switch to place the seat is appropriate to determine the first light paste location (with the control switch to connect the first line).
4. The bottom of the product is double-side adhesive tape tear off the film, and then affixed to the first lamp position ,forced down, so that double-side adhesive is pasted better. Make the tape and the bonding surface get full contact.
5. After the installation, the rotating bulbs will shrink the redundant connecting wires and hide them in the bottom shell to ensure the simple and beautiful installation and achieve the best use effect.
6. When you use the lights, you can adjust the color temperature and the brightness with the function buttons. And choose your favorite color!