

---

# **OFFICE CHAIR ASSEMBLY INSTRUCTION**



Hello Friend,  
Thanks for choosing our office chair.



Our chair comes with product warranty service.

If you have any issues, please contact our online service team immediately, will provide you with a satisfactory solution within 24 hours.

Please feel free to contact us via the following path:

Path 1: Contact us via Amazon

Login your Amazon Account

"Your Order" > find the order ID > click "Contact Seller"

#### Damaged or Missing Component

Promptly re-send component from amazon

#### Quality Problem

1. Promptly re-send product from amazon
- OR**
2. Order Refund

## ATTENTIONS

1. Use this product only for seating one person at a time
2. Do not stand on the chair use as a step stool or ladder
3. Do not use the chair unless all bolts, screws and knobs are tight
4. Do not place the product near the fire or heat source !
5. Do not use corrosive cleaners for cleaning !
6. This product is not a climbing frame for children's play, which could result in injury. Please do not leave children unattended



Filling material(s) and covering fabric(s) meet the requirements for resistance to cigarette and match ignition in the Furniture and Furnishings (Fire) (Safety) Regulations 1988

**CARELESSNESS  
CAUSES FIRE**

**UK REP**

Name: Sea&Mew Accounting Ltd  
Address: Electric Avenue Vision  
25, London, Enfield EN3 7GD  
Contact Person: BillyHan  
E-mail: info@seamew.net  
Tel: +44 7399648608

## Q&A

Q: Where can I get installation instructions?

A: You can also contact us if you need an electronic instruction document or further assistance.

Q: Can I complete the installation independently?

A: if you need to install the chair independently, we recommend that you put the seat cushion on a higher table or chair to assist your installation. please refer to our instructions.

Q: How to adjust the lumbar support?

A: The height of the lumbar support can be adjusted by pushing the plastic slider up and down. ( Please keep your back away from the backrest for smooth adjusting of the slider.)

Q: How to adjust if the chair is tilted forward?

A: It may be due to the wrong orientation of the tray and the seat cushion, please keep the tray and the seat cushion in the same direction as indicated.

Q: If the screws are not aligned with the holes during installation, how can I adjust them?

A: You can put the screws into the corresponding holes first, and tighten them halfway. And then fully tighten all the screws after the screws are set.

Q: What should I do if the package lacks some components?

A: Please feel free to contact us for prompt help if the package lacks some components.

Q: What should I do if my package were damaged?

A: Long-distance transit may cause damage to the item under special circumstances, please feel free to contact us for prompt help.

**Thanks for your support!**

**If you need further assistance, please feel free to contact our customer service team for prompt help, we will do our best to help you.**

## ▲ IMPORTANT

Please follow the instruction manuals and use a pad to avoid damage during assembly.

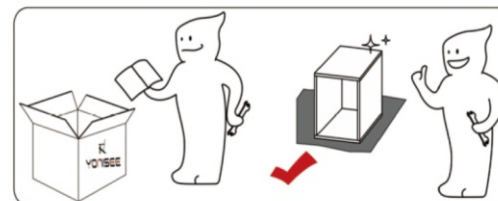
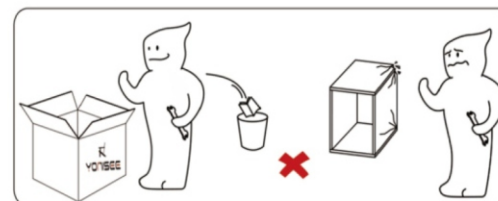

For easier and better assembly, **1** or more adults are required.



The expected assembly time for this product is **0.5 h**, depending on the individual's manipulative ability.



Not intended for use by children. Please keep your children closely supervised.



Keep away from fire or other heat sources.



Do not use harsh cleaner for cleaning!















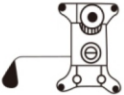

We recommend wearing protective gloves for assembly.



Identify, sort and count the parts before assembly.

Please Make sure all parts are included

			
Backrest - 1pcs	Seat Cushion - 1pcs	Left Armrest - 1pcs	Right Armrest - 1pcs
			
Tray - 1pcs	Base - 1pcs	Gas Lift - 1pcs	Wheel - 5pcs
			
Wrench - 1pcs	Screw ( M6*22) - 10pcs	Screw (M6*30) - 4pcs	Washer - 8pcs
			
Headrest - 1pcs	Cover - 1pcs	Tight the Armrest	



Notice: Before installation, please classify the screw, measure the screw length for easy assemble  
(Each screw comes with 1 backup)

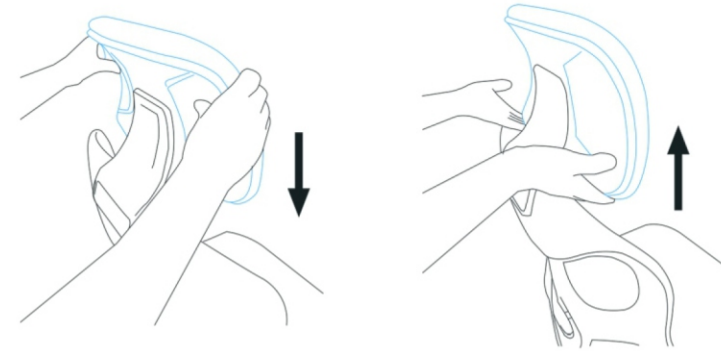

Note: Please refer to the above image to adjust the height of the headrest if necessary





**! NOTE**

Note: When lowering down the seat height, please make sure to fully sit on the seat (as the right figure shows below) in order to give it enough pressure.

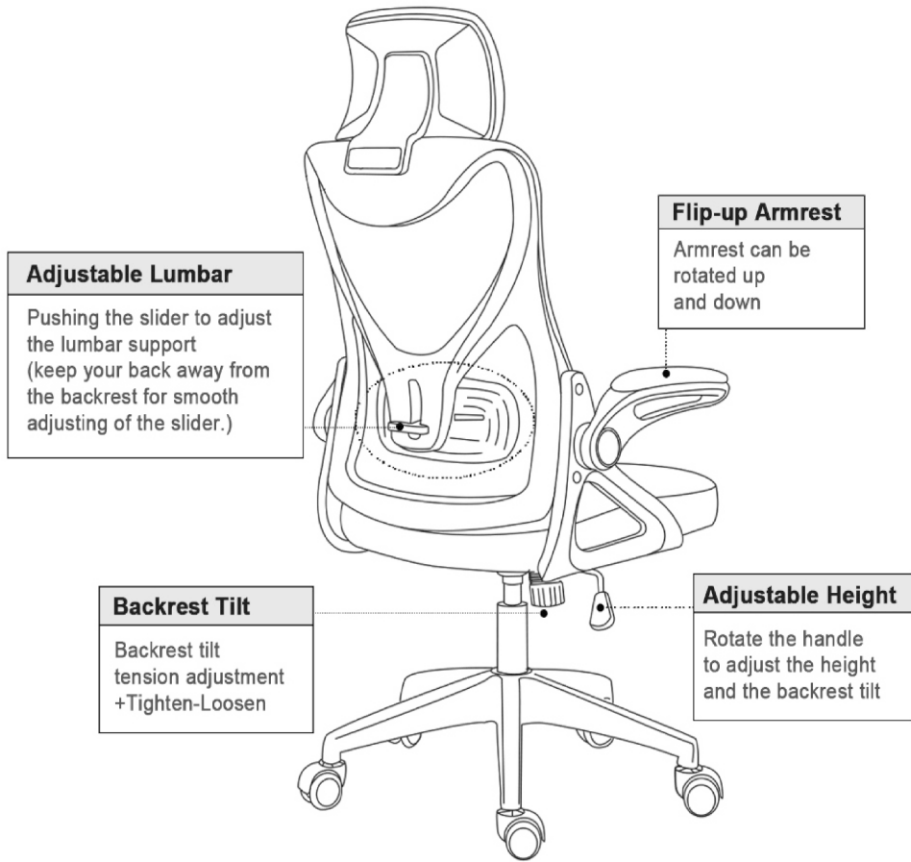
# Multiple Functions



STEP 1	
(F)	 x1
(H)	 x5

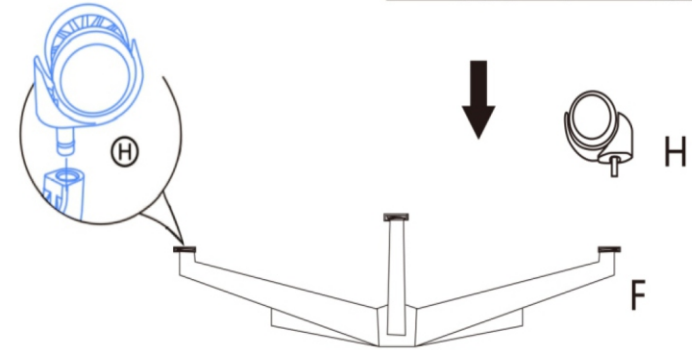
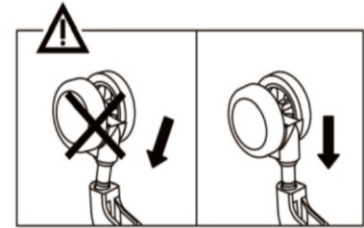

STEP 2	
(G)	 x1

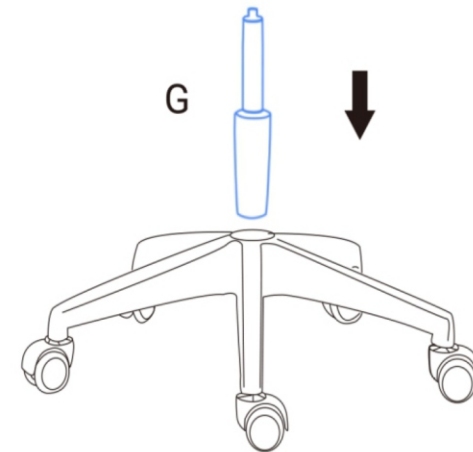



## How to adjust the tightness of the armrest?

 The armrests are adjusted to the ideal tightness at the factory, If you don't need it, skip it please.

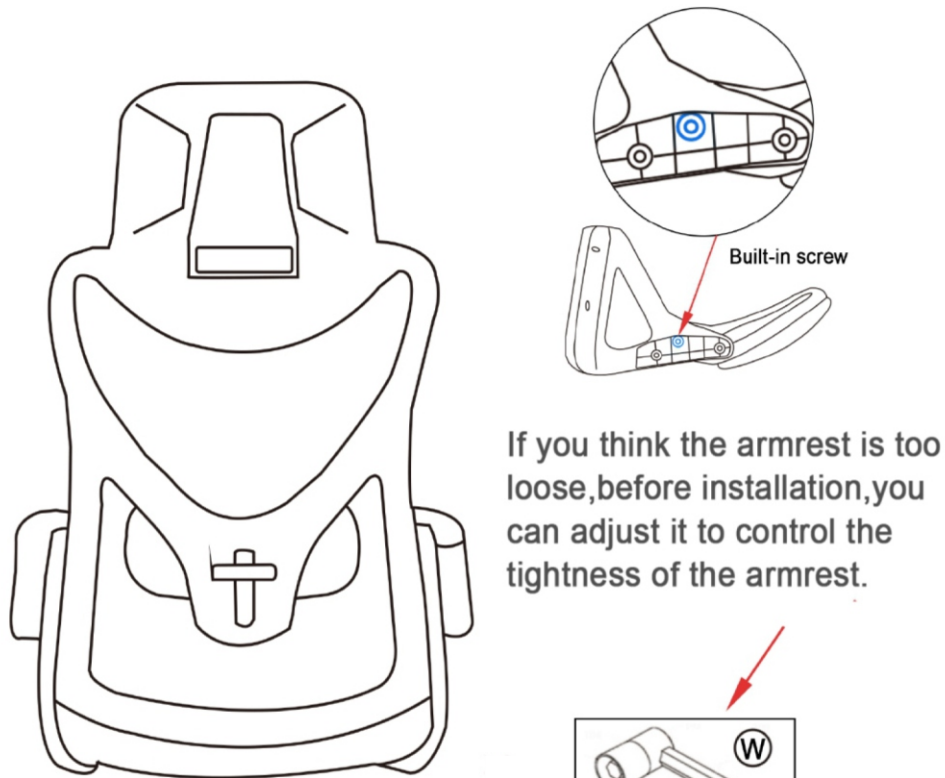

If you think the armrest is too loose, before installation, you can adjust it to control the tightness of the armrest.

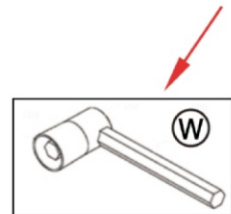

You can use this wrench



## Setup Method

### Tips 1: Height Adjustment

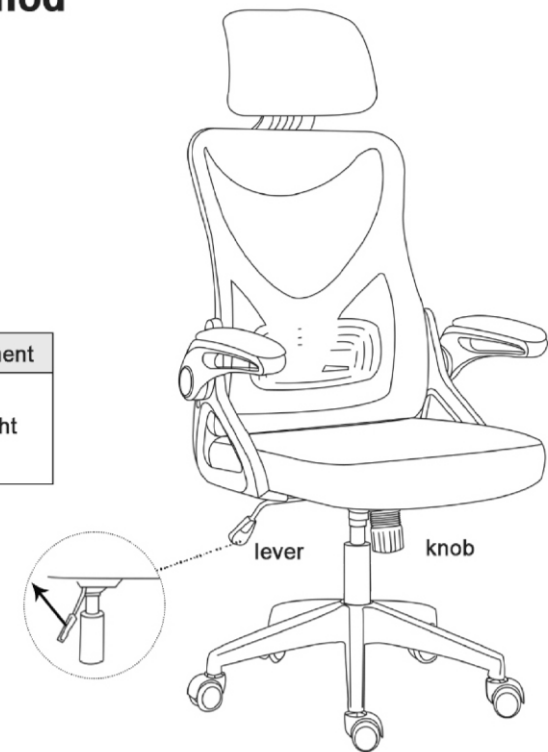
press the lever  
to adjust the seat height  
up and down

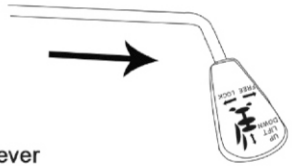

### Tips 2: Tilt Tension Adjustment

 • lever	 • knob
Step 1 pull out the lever to active the rocking mode	Step 2 twist the knob to control the tilt tension

### STEP 9



For better using experience, After all the screws are set, please twist one more time to fully tighten them



### STEP 3

(A)		x1
(C)		x1
(D)		x1
(J)		x4

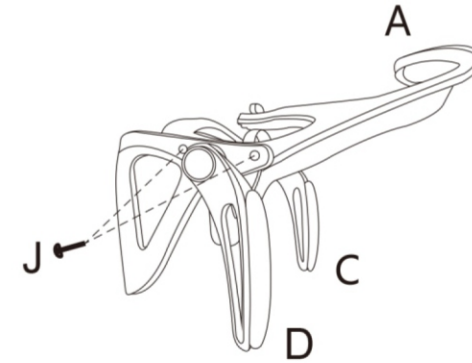

Assemble the armrest and back firstly.



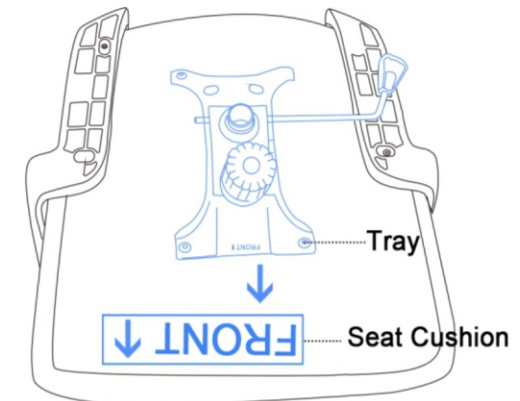

### NOTE

Note: During the assembly, please first half-tighten all the screws into the holes. After all the screws are set, fully tighten them.

### STEP 4



Please notice the direction of the tray and the seat cushion  
Keep the same direction as indicated

STEP 5		
(B)		x1
(E)		x1
(J)		x4
(K)		x4
(L)		x8

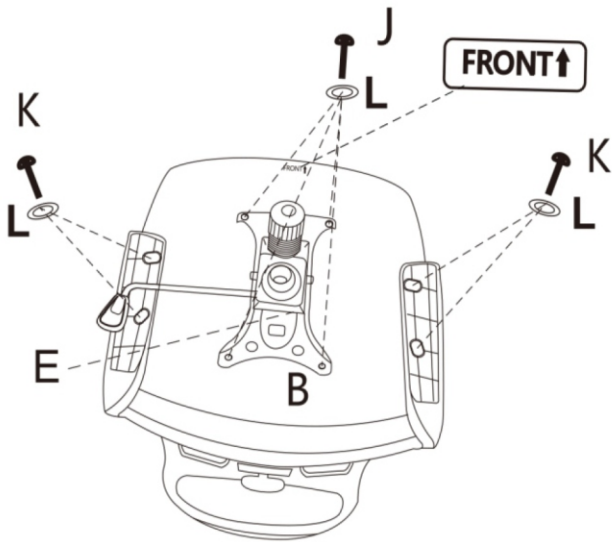

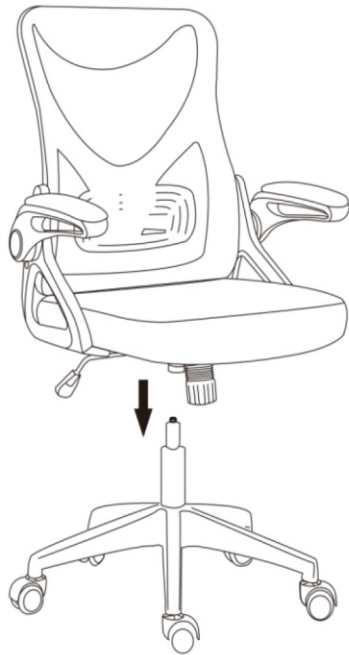

Assemble the armrest and seat cushion first.  
After that attach the mechanism on the seat cushion.  
Please notice the direction!

### STEP 6



Assemble the chair with two whole parts

STEP 7		
(J)		x2
(M)		x1



STEP 8		
(N)		x1

