

Installation Manual

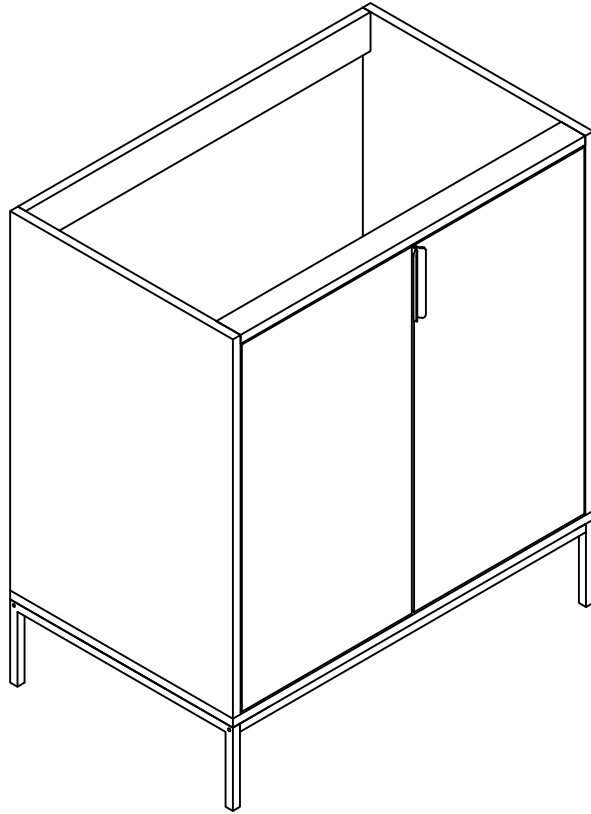

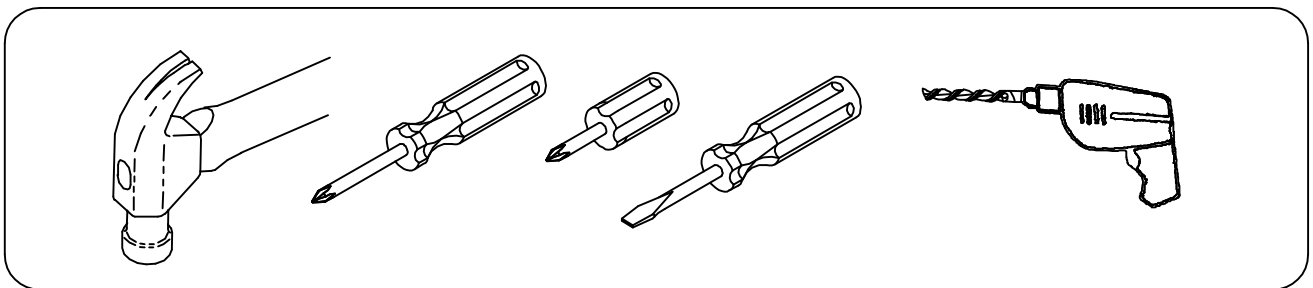







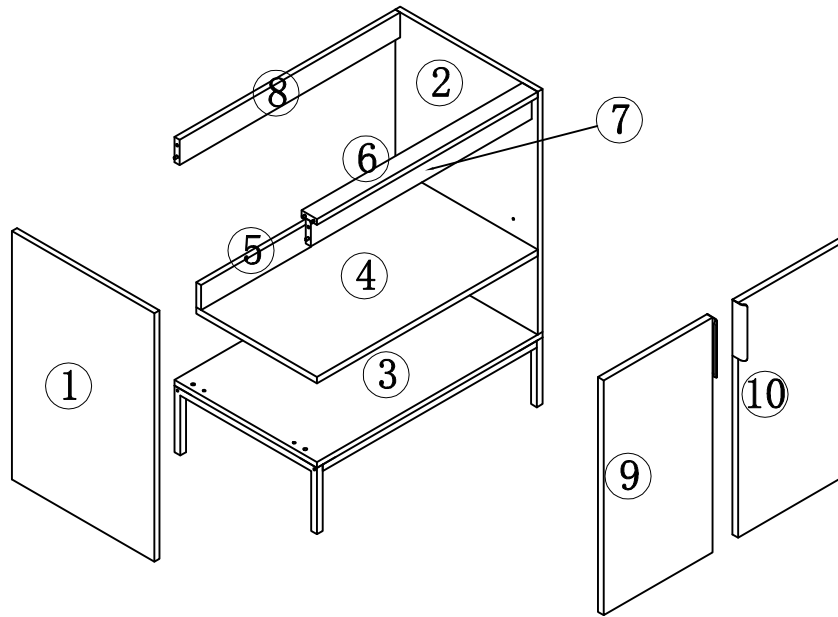

For the convenience and neatness of reading the manual, the door panel here is displayed using a simple drawing method.



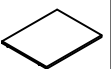









YOU MAY NEED (NOT SUPPLY)





ASSEMBLY DIAGRAM



PARTS LIST					
PARTS LIST					
NO	DESCRIPTION	QTY	NO	DESCRIPTION	QTY
①	Left side panel 	1	⑥	Front fixed panel 	1
②	Right side panel 	1	⑦	Front fixed panel 	1
③	Bottom panel 	1	⑧	Back fixed panel 	1
④	Clapboard 	1	⑨	Left door panel 	1
⑤	Back fixed panel 	1	⑩	Right door panel 	1

PARTS LIST					
HARDWARE LIST					
NO	DESCRIPTION	QTY	NO	DESCRIPTION	QTY
A	Three-in-one eccentric wheel 	12	H	4*12mm screw 	4
B	Three-in-one connecting rod 	12	I	4*30mm screw 	4
C	Three-in-one sticker 	12	J	4*35mm screw 	4
D	8*40mm wood dowel pins 	12	K	Door handle 	2
E	Two-in-one lock handle 	4	L	Metal feet 	1
F	Two-in-one screws 	4	M	Door hinges 	4
G	4*16mm screw 	24			
CAUTION: Please confirm the parts list before installation					

STEP 1

HARDWARE LIST		
Three-in-one connecting rod B  12PCS	Two-in-one screws F  4PCS	

1. Put the three-in-one connecting rod in the 10mm hole of the following panels and tighten them with a cross screwdriver or an electric tool.

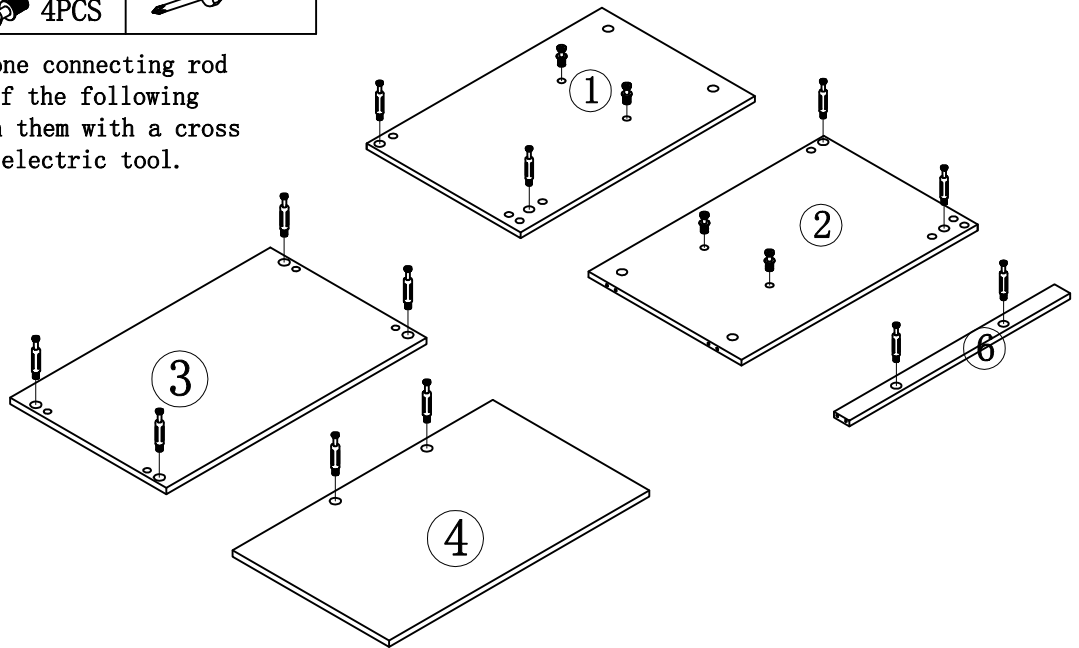
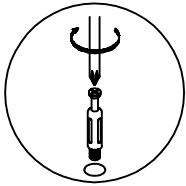

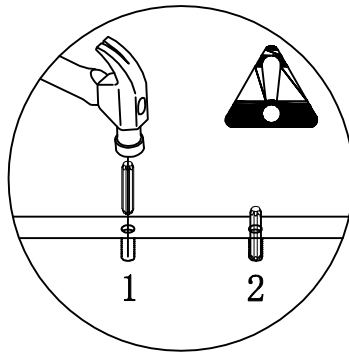

STEP 2

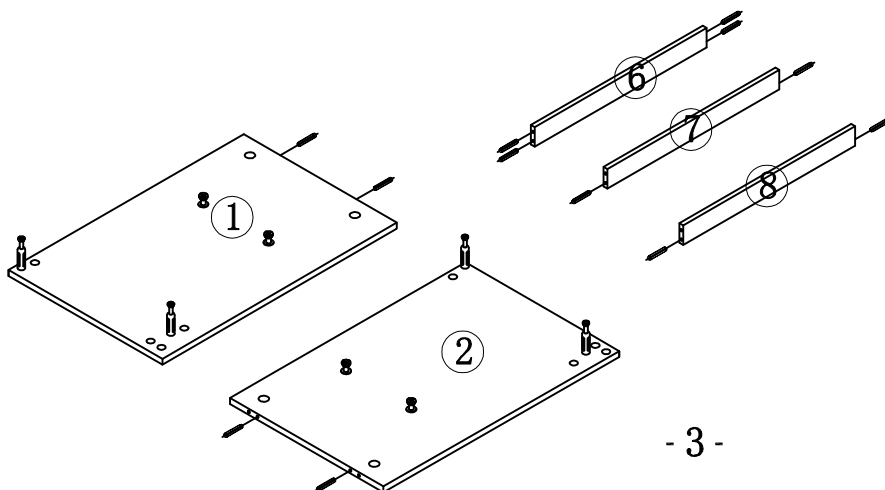

1. Strike the 08*40mm wood dowel pin into the 8mm hole of the above panels with an iron hammer. Please note that the hole of the three-in-one connecting rod should also be 8mm. The hole of the three-in-one connecting rod connects to the hole of 15mm three-in-one eccentric wheel.



HARDWARE LIST	
8*40mm wood dowel pins D  12PCS	

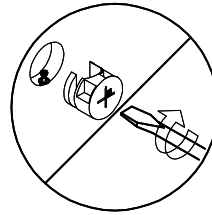
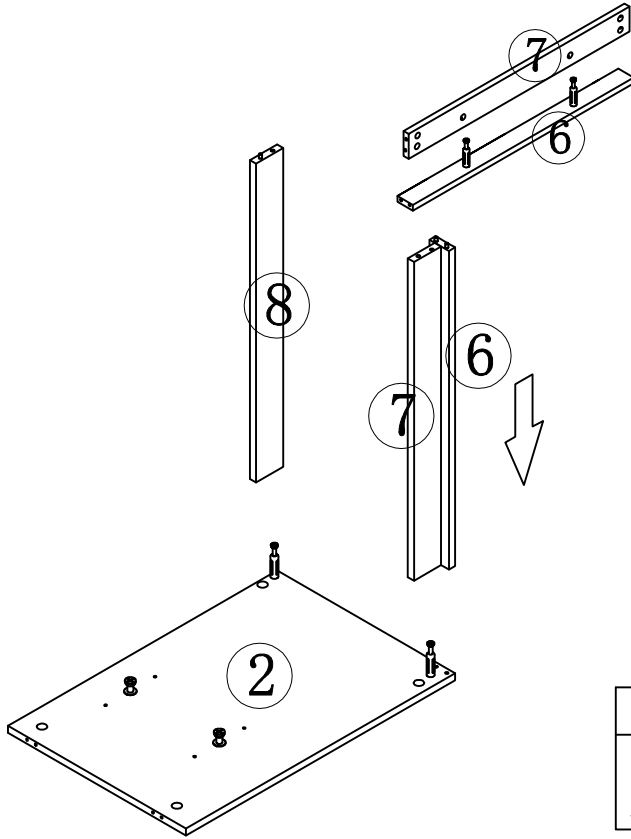

STEP 3

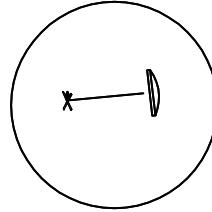

1. Connect No. 6-7-8 panel to No. 2 panel tightly with the three-in-one eccentric wheel.



2. Cover the mounting hole of the eccentric wheel with a three-in-one sticker.

HARDWARE LIST		
Three-in-one eccentric wheel A  4PCS	Three-in-one sticker C  4PCS	

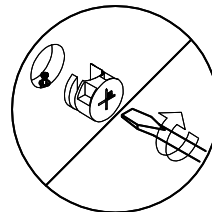
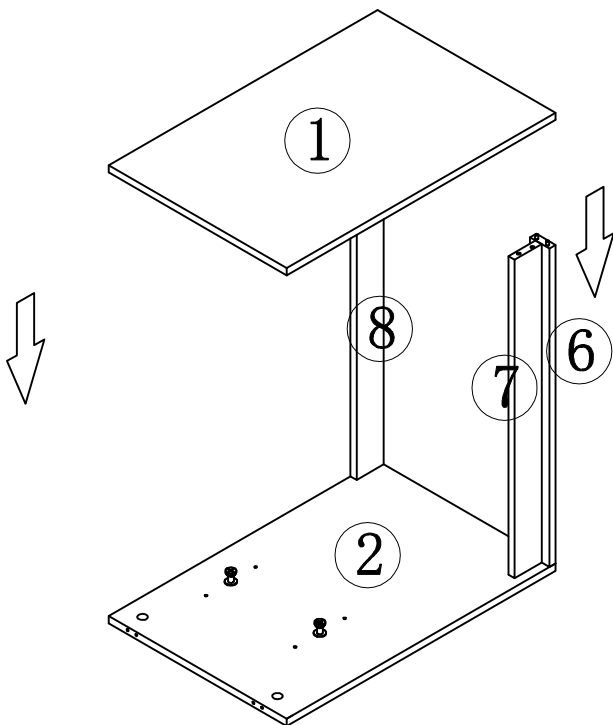

STEP 4

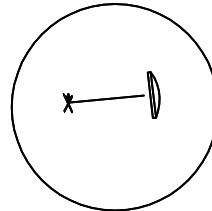

1. Connect No. 1 panel to No. 6-7-8 panel tightly with the three-in-one eccentric wheel.



2. Cover the mounting hole of the eccentric wheel with a three-in-one sticker.

HARDWARE LIST		
Three-in-one eccentric wheel A  2PCS	Three-in-one sticker C  2PCS	

STEP 5

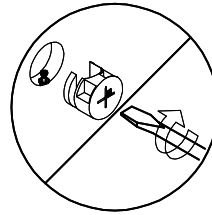
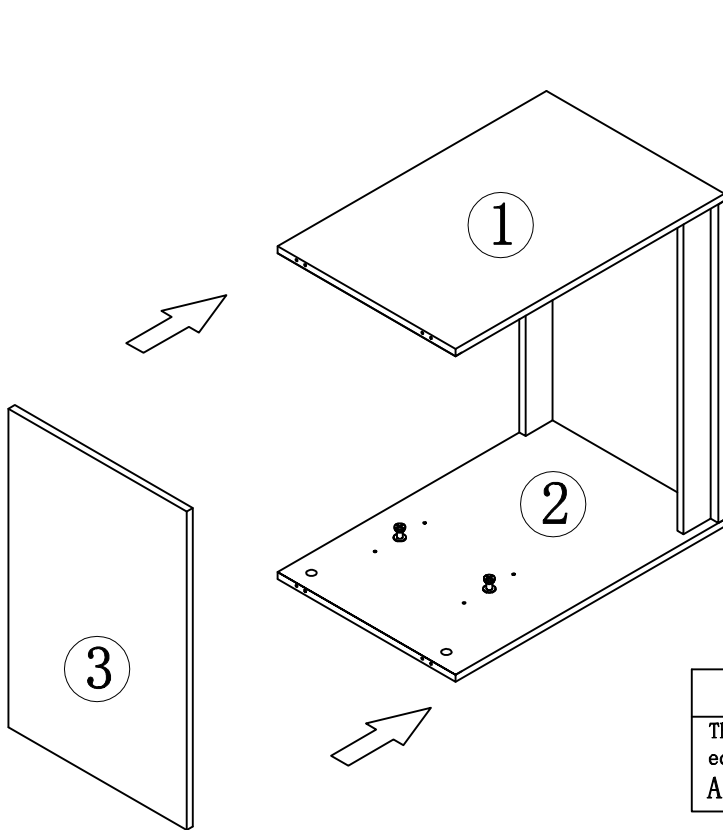

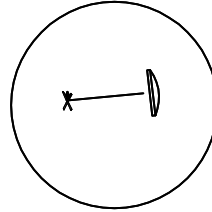

1. Connect No. 1-2 panel to No. 3 panel tightly with the three-in-one eccentric wheel.



2. Cover the mounting hole of the eccentric wheel with a three-in-one sticker.

HARDWARE LIST

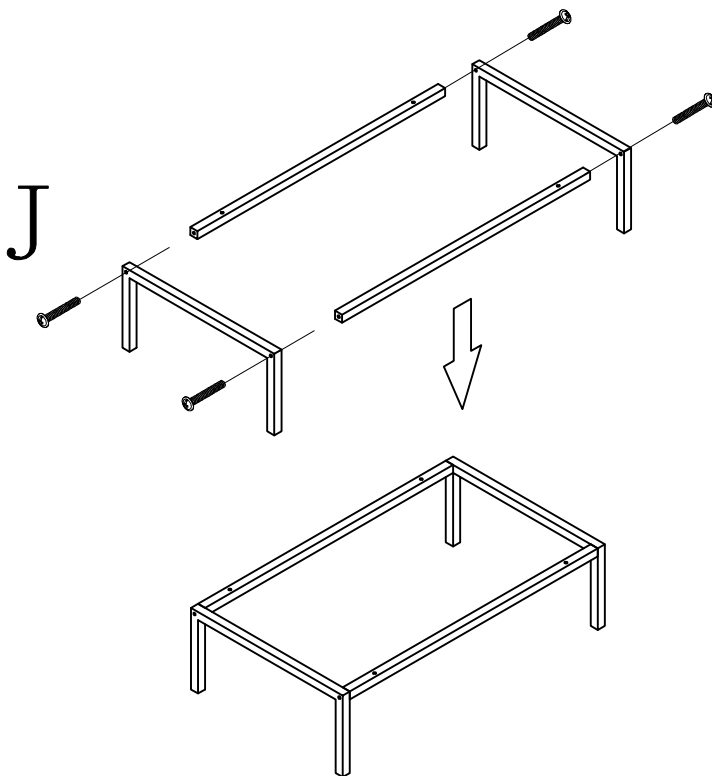

Three-in-one eccentric wheel A  4PCS	Three-in-one sticker C  4PCS	
---	---	--

STEP 6



Use 4*35 screws to assemble the metal feet



HARDWARE LIST

Metal feet L  1PCS	4*35mm screw J  4PCS	
--	--	---

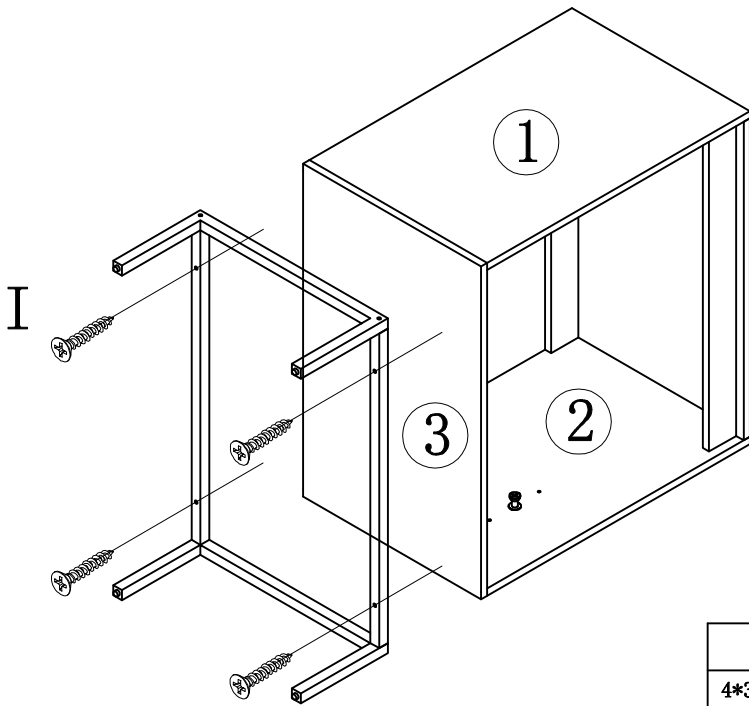
STEP 7



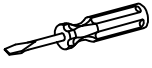

Use 4*30 screws to fix the Metal feet

HARDWARE LIST		
4*30mm screw	Metal feet	
I  4PCS	L  1PCS	

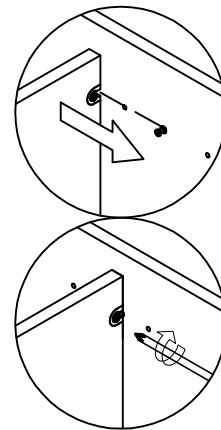
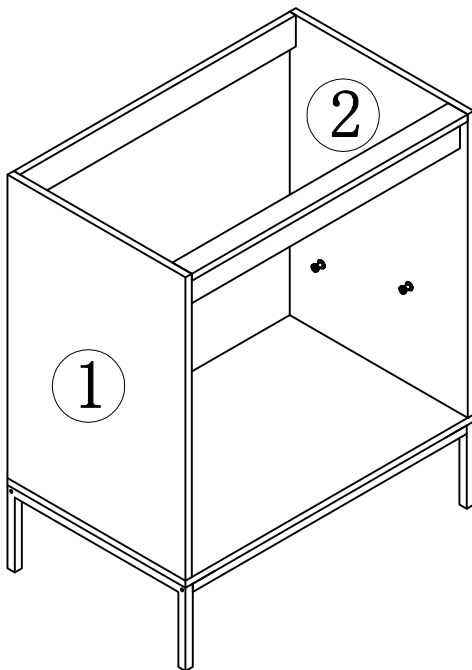
STEP 8

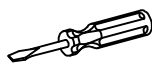

Fix the two-in-one lock handle on No.4-5 plate and put it in the cabinet. Put the pipe plug on No. 4 plate

HARDWARE LIST			
Three-in-one eccentric wheel A  2PCS	Three-in-one sticker C  2PCS	Two-in-one lock handle E  4PCS	

STEP 9

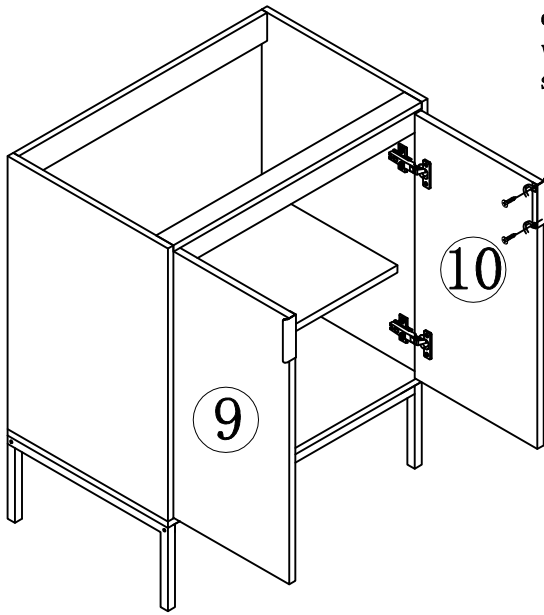

Install the door handle with 4*12mm screws.

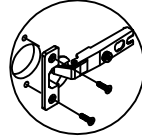

1. Install the hinge cup to the door panel with 4*16mm screws.

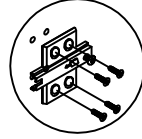

2. Install the hinge to the side panel with 4*16mm screws.

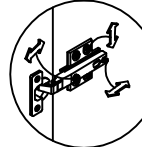

4. Adjust the door panel clearance.

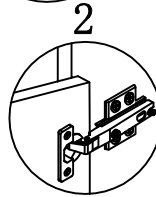
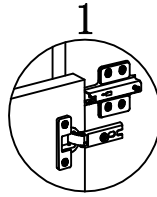

3. Install the hinge cup on the door panel to the hinge of the side panel.

HARDWARE LIST				
4*16mm screw	Door hinge	Door handle	4*12mm screw	
G  24PCS	M  4PCS	K  2PCS	H  4PCS	

Hinge/Door Adjustment and Realignment

If adjustment or realignment is needed, follow the instructions provided in the following chart.

Vertical adjustment

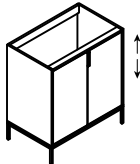

1. Loosen screws

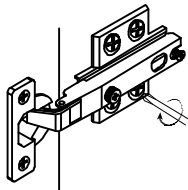

2. Adjust hinge

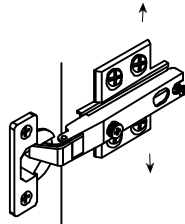

3. Tighten screws

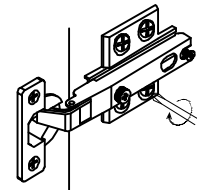

Horizontal adjustment

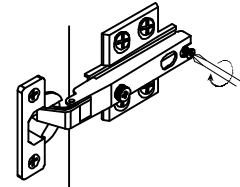
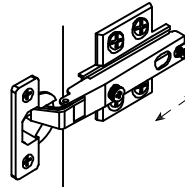
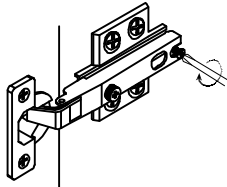
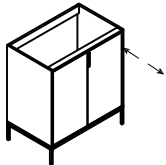

Door gap adjustment

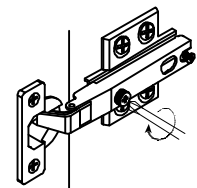
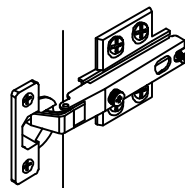
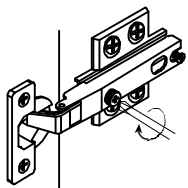
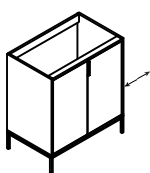



Choking hazard-Small Parts : This unit contains small parts, not for children under 3 years.

Tip-over hazard : Secure finished unit to wall stud using L-Bracket and wall screw (#10*1.5"W/out provided). If a wall stud is not neccessible , Consault your local hardware store for appropriate mounting hardware . Failure to properly install will result in product collapse or tip-over. Serious injury can occur .