

Murphy bed / Lit escamotable

Assembly Instructions - Please keep for future reference

Instructions d'assemblage - s'il vous plaît garder pour référence future

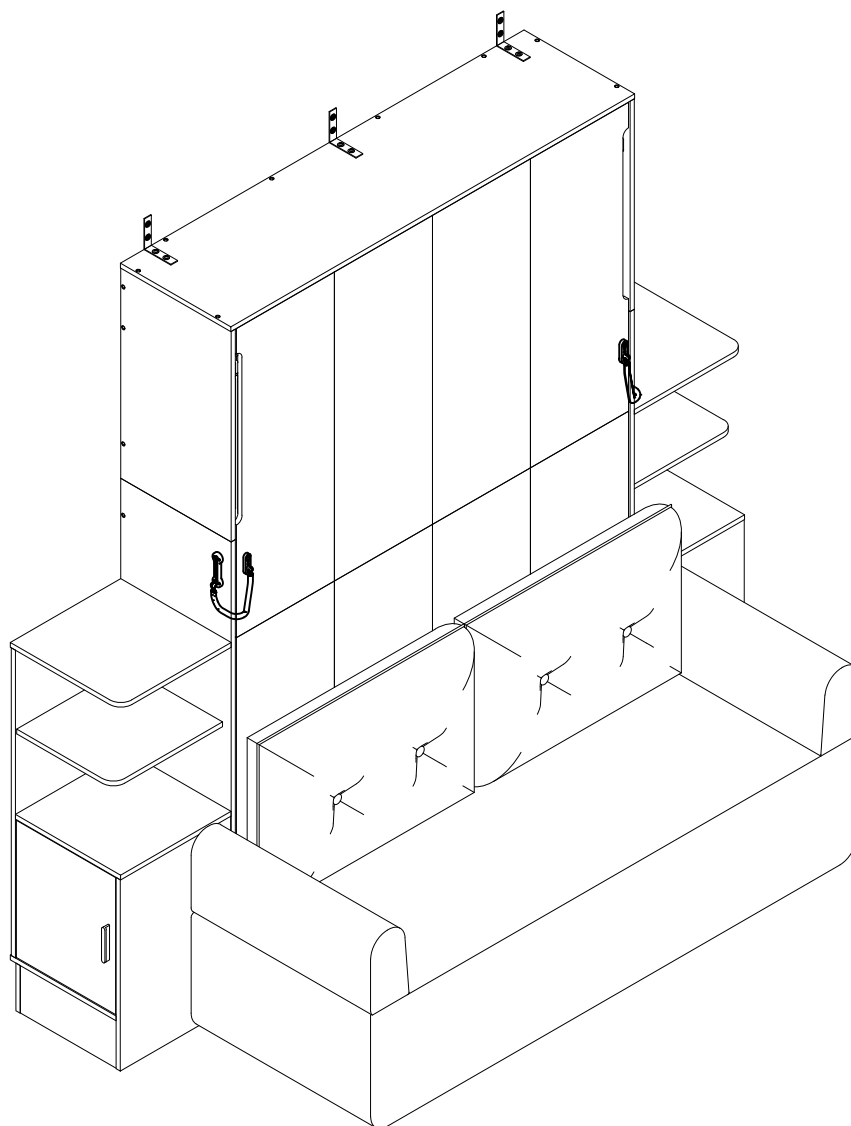

Three people are required to assemble and move this model.
Trois personnes sont nécessaires pour Assembler et déplacer ce modèle.

Important – Please read these instructions fully before starting assembly

Important - veuillez lire ces instructions complètement avant de commencer l'assemblage

IMPORTANT INFORMATION PACKAGE.

THIS INFORMATION PACKAGE CONTAINS WARNING AND PRODUCT SAFETY INFORMATION. DO NOT PROCEED WITHOUT REVIEWING THOROUGHLY.

A. WARNING LABELS.

Your purchased Murphy Bed is delivered to you with WARNING LABELS to constantly remind you to take and adopt Safety Measure throughout the entire assembly and mounting points of the Bed to the walls.

DO NOT REMOVE these labels.

These Warning Labels serve as a Reminder Tool for visiting friends and relatives when using the Murphy Bed to ensure Safety Precautions are taken.

B.) SAFETY REMINDERS.

MARKINGS in WALL – WHERE TO ATTACH the MURPHY BED.

Irrespective of the wall type, whether Solid Concrete Walls OR Decorative Walls with WOODEN Studs OR Decorative Walls with Metal Studs, ensure that

- a.) you choose a professional installer who has a good understanding of the wall structure where the Murphy Bed is anchored, including the position of the wall studs and structural components in the case of a wood or metal structure.
- b.) precise markings of the positions of the anchor points are to be made on the wall for easy identification during the Murphy Bed attachment to the wall.
- c.) the relevant and appropriate Hardware with Metal Brackets are READY for this attachment and are within easy access for prompt and efficient attachment.

This product requires Professional Consultation and Installation*.

* When you choose the professional installer, make sure to comply with all applicable laws, regulations and rules in the city, state or country where the Murphy Bed is installed.



WARNING.

IMPORTANT SAFETY REQUIREMENTS - Bed Attachment to Wall.

For Your Safety, the Murphy Bed MUST BE ATTACHED to the Wall.

Seek Certified Professional Consultant / Contractors for their Services to:

- 1.) DETERMINE the WALL Type in Your Home;
- 2.) PRECISE HARDWARE that suits to the Wall Type in Your Home;
- 3.) INSTALL / ATTACH of the Murphy Bed to the Wall in Your Home;
- 4.) VALIDATE the Murphy Bed is appropriately and securely installed/attached.

The choice of wall anchoring hardware depends on the type of wall. This Murphy Bed is delivered with **HARDWARE SCREWS** suited for attachment to **WOOD STUDS** in walls. Any **STUDS** type detected with your Consultant-Contractors to be **NOT WOOD STUDS** - **DISCARD** and **DO NOT USE** these **SCREWS**. Use the hardware suitable for your wall material.

Seek the professional advice of your Consultant-Contractor and procure the appropriate hardware and brackets for the attachment of the Murphy Bed to the Wall.

FAILURE TO ADHERE TO THE ABOVE INSTRUCTIONS MAY RESULT IN SERIOUS and/or SEVERE INJURIES or Death caused by the detachment of the Murphy Bed from the Wall.

SAFETY PRECAUTION :

- 1.) **MAXIMUM Mattress Weight** suited to your Murphy Bed :**50.9lbs (23 kg)**;
MAXIMUM mattress thickness: 9.8 inches (25 cm);
- 2.) **ENSURE ADULTS ONLY** throughout the entire assembly and attachment.
- 3.) **KEEP ALL Children, Non-Ambulatory persons and Pets** at bay during the entire assembly and attachment.

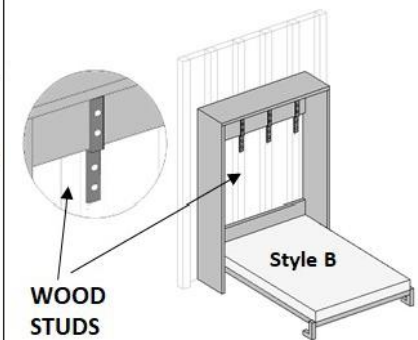
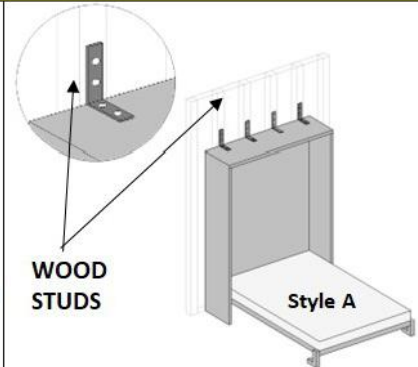

LINE ART for Reference only and NOT DRAWN TO SCALE.

CAUTION : Homes are renovated differently. There are CONCRETE walls and "hollow walls". Hollow walls are reinforced with STUDS of Wooden or Steel Materials. Seek advice from professionals.

Style A - VERTICAL Murphy Bed with SEALED/CLOSED Back board.

Style B - VERTICAL Murphy Bed with OPEN STYLE Back board.

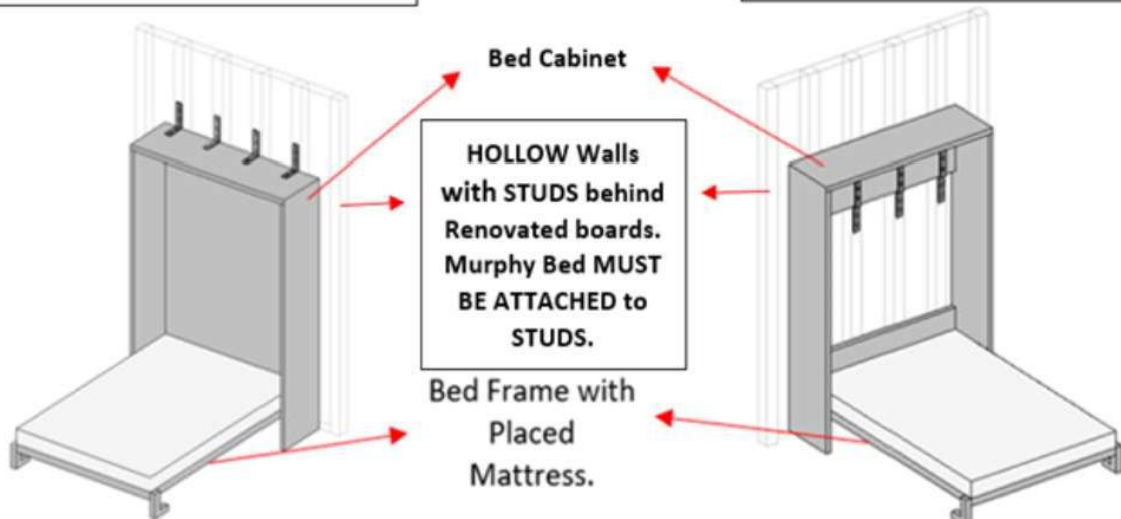

To have your Murphy Bed fully assembled and to achieve its intended functionality – you MUST READ through this entire Assembly Instructions Manual before you start the assembly of the bed

1.) There are numerous Safety Issues and Safety Precautionary Actions that you MUST KNOW before you start the Assembly.

2.) CAUTION - Failure to FOLLOW / ADHERE to the GUIDE, WARNING AND REMINDERS here, may result in serious / severe injuries or death.

3.) PRECAUTION : For the assembly, Adult Partners only, to assist in the entire assembly. Ensure 4 (four) to 6 (six) ABLE BODIED PERSONS ONLY in the entire assembly and attachment of this Murphy Bed to the walls of your home.

4.) CAUTION : During the entire assembly process and attachment of the Murphy Bed to the walls of your home, Keep ALL Children, Non-Ambulatory Persons and Pets completely at bay.

6.) SAFETY REMINDER on / to : Personal, Family Members and Pets. The Murphy Bed may be shipped to you in 3 to 5 packages and are HEAVY. Each carton holds many parts and components. Some of these components eg., bolts and screws are relatively small* in size.

*. During the assembly process, ensure that any misplaced bolts and nuts are picked up so that Children and or Pets do not play or ingest these.

7.) This Murphy Bed is intended for ADULT USE ONLY.

8.) This Murphy Bed is delivered to you pre-packed with Hardware - suitable for wood-framed walls renovated with WOOD STUDS ONLY.

9.) Your Home's Wall Type - Every home is renovated differently with different wall(s) type / finishes. Before you proceed to assemble your Murphy Bed :

- a.) SEEK and CONSULT Professional Services to ascertain the wall type in the designated location where you intend to attach the Murphy Bed;
- b.) ENSURE the Consultant-Contractor specifically INFORMS you of the WALLTYPE in the designated spot where you intend to attach the Murphy Bed.
- c.) ENSURE the Consultant INFORMS you specifically on the matching and relevant Hardware / Brackets to secure and attach the Murphy Bed to the wall.

10.) WARNING – YOU MUST HEED THE INSTRUCTIONS given by your appointed Consultant-Contractor on the :

- a.) Mounting Hardware Type that suits the wall(s) type - where / when it is NOT WOOD STUDS, the pre-packed Screws for Wood Stud Walls would not match/ not fit.
- b.) Number of Mounting Points for the Murphy Bed to the Wall.

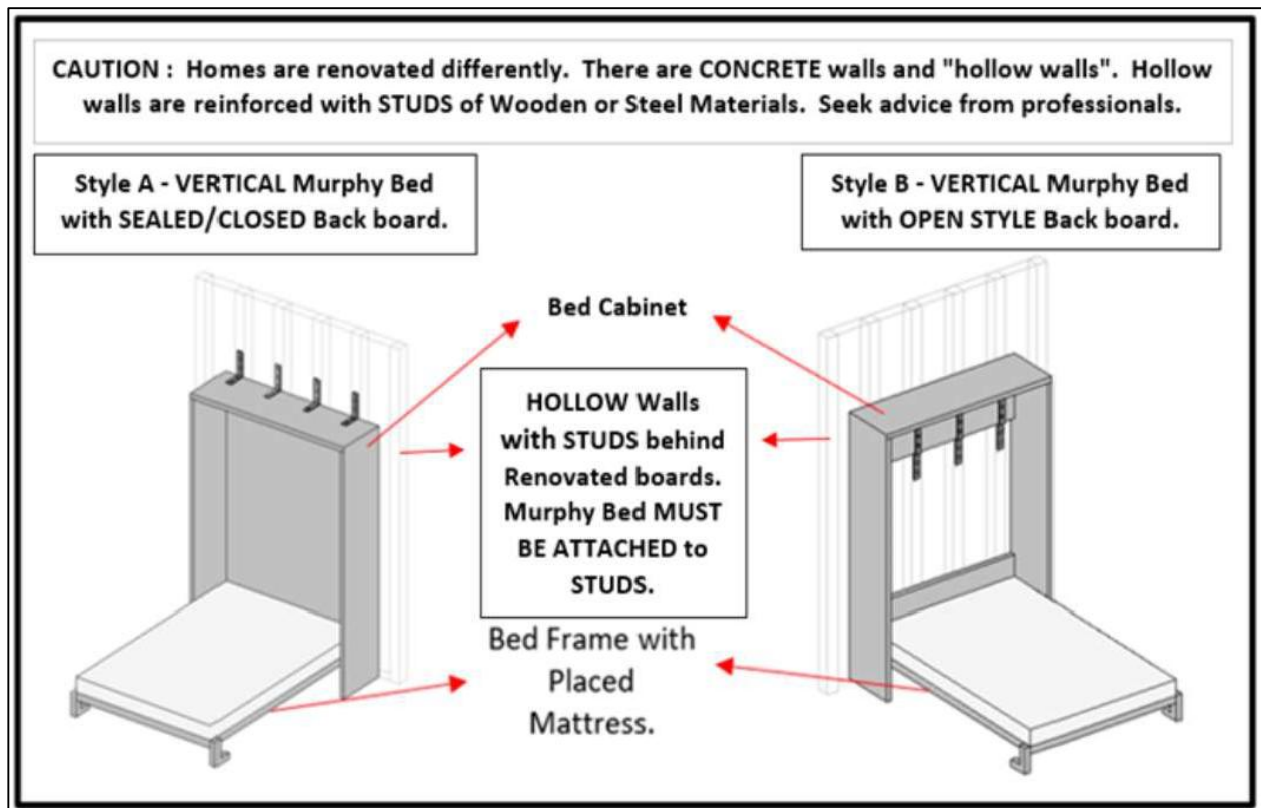

11.) This Murphy Bed is designed for home use and not intended for commercial use.

12.) This Murphy Bed is not intended to be moved, modified, uninstalled or disassembled once professionally installed.

C.) MOUNTING INFO & HARDWARE.

1.) REMINDERS :

- a.) In the event, that this pre-packed Screws Set does not match to the walls in your home – DO NOT USE / DISCARD these hardware.
- b.) **ADHERE** to the Professional Consultant-Contractor instructions and information on the **RELEVANT** mounting hardware that suits your wall.
- c.) Procurement of these **RELEVANT** hardware is an arrangement made between your Consultant-Contractor and you.

2.) A step ladder (not provided) is needed to attach the L-Brackets to the wall, at the Top of the Murphy Bed. DO NOT lean against the Top of the Murphy Bed, it may cause sagging.

Murphy Bed Style A

L-Bracket Fixture to Wood Studs

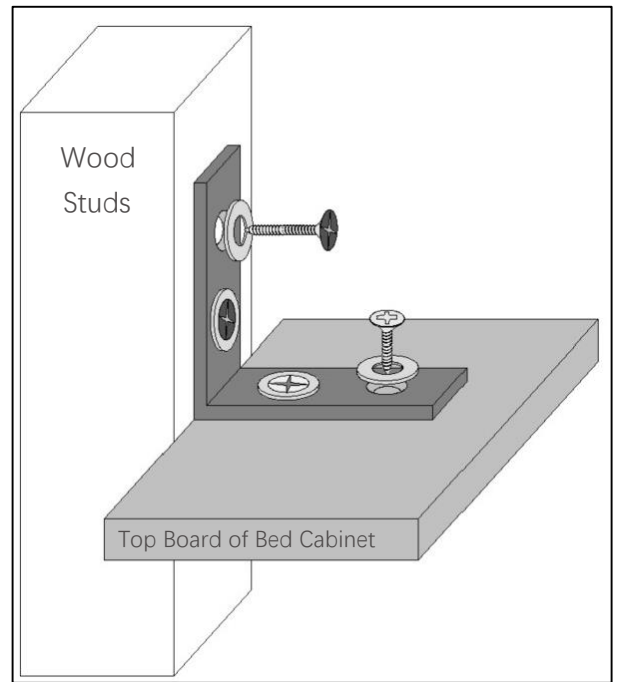
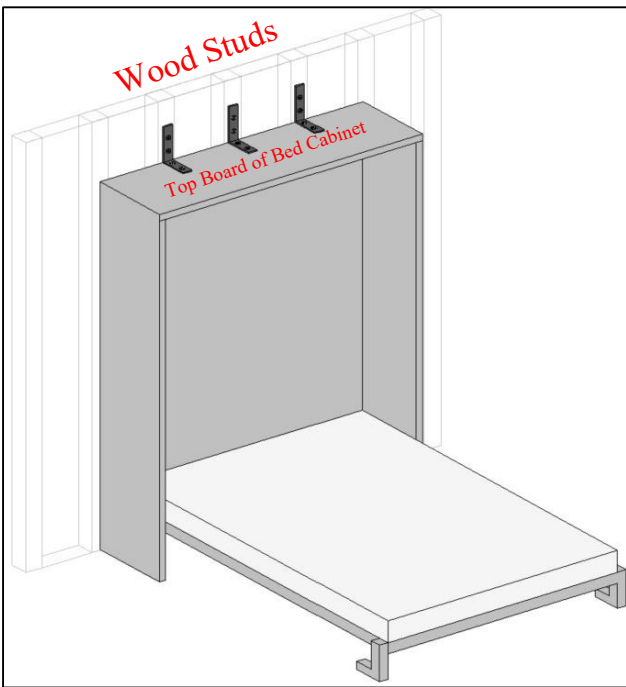

D.) IDENTIFICATION of TOOLS and ATTACHMENT SKILL.

The parts and components to assemble the Bed Frame are stated in the Assembly Instructions. Follow the instructions with attention.

For an efficient assembly, after opening the cartons shipped to you :

- a.) open and layout all parts and components in sequence;
- b.) account for every part, hardware and component;
- c.) then lay out the parts close to each other;

Assemble and tighten each bolt / nut / screw up to 80% to allow for the Bed Frame and Bed Cabinet to be HELD together.

Upon FINAL assembly where all the parts and components are FITTED precisely, in a sequential manner – proceed to tighten each bolt & nut & screw gradually.

CAUTION :

- 1.) The METAL PLATES to the sides of the Side Rails – MUST BE FULLY and SECURELY TIED to the SIDE RAILS.
- 2.) The Piston L-Brackets that are attached to the INNER WALL of the Bed Cabinet – MUST BE FULLY and SECURELY TIED to these Inner Walls.
- 3.) These Metal Plates and the L-Brackets – are the components that are holding the Pistons that allow your Bed to “travel” to an OPEN or CLOSED position.
- 4.) Frequent Inspections of these Metal Plates / Brackets and Pistons Bolts, up to Once a Month – to ascertain these DO NOT BECOME LOOSE. For if these bolts to the Bed Frame and or Bed Cabinet or Pistons are loose, may cause the BED FRAME to become DISLODGED and cause injuries.

REMINDER : NEVER FULLY TIGHTEN any screw / nut or bolt in one session. If you DO TIGHTEN the hardware all the way into the core of the wood, this cause the parts to become skewed that would impact other parts of the item not being able to be aligned to its mounting points for assembly.

E. ALL ASSEMBLY WORKS REQUIRES A TEAM OF NO LESS THAN 4 ADULTS.

Reminder : Per above info, the cartons and products are heavy – therefore exercise CAUTION at all times and ENSURE YOUR TEAM OF 4 for the entire ASSEMBLY.

F.) ASSEMBLY of BED FRAME.

Identify all parts and components for the Bed Frame.
Assemble the Bed Frame according to the Assembly Instructions.

Upon completion of assembly of the Bed Frame, make a final inspection that all joints and parts are fully and securely attached.

Then place this assembled Bed Frame horizontally flat on the ground, some 10feet away, so as to allow room for the assembly of the Bed Cabinet.

G.) ASSEMBLY OF BED CABINET.

Identify all parts and components for the Bed Cabinet.
Assemble the Bed Cabinet according to the Assembly Instructions.

Upon the completion assembly of the Bed Cabinet, make a final inspection that all joints and parts are fully and securely attached.

CLEAR all debris in the area where your Murphy Bed is going to be attached to the wall.

Move this FULLYASSEMBLED BED CABINET and position this BED CABINET some 2feet to 3 feet away from the designated Wall, where you have previously made markings.

SAFETY REMINDER – The Cabinet is NOT ATTACHED TO THE WALL, YET. From here on - YOU MUST HAVE 2 ADULT to HOLD and STABILISE this BED CABINET, to prevent the Bed Cabinet from TIPPING OVER.

H. ATTACHMENT OF BED FRAME TO BED CABINET.

Safety Reminder : DO ENSURE the 2 adult persons holding the Bed Cabinet is IN POSITION ALL THE TIME.

The other 2 adults shall lift and carry the Bed Frame and attach to the L-Bracket – at the inner walls of the Bed Cabinet.

Thereafter, gently LIFT THE Bed Frame to a CLOSED POSITION.

I.) ATTACHMENT OF PISTONS TO HOLD & SUPPORT BED CABINET TO BED FRAME.

The Murphy Bed, is now still placed at 2feet to 3feet, from the wall.

The 2 adults, upon attachment the Bed Frame to the Bed Cabinet, shall get the Pistons, and move to the back of the Murphy Bed. Both persons shall - then attach the Pistons to the Bed Frame and Bed Cabinet.

You may need to – LIGHTLY slide forward-backward to adjust and create gap space so as to enable the Pistons to be hooked to both ends of the hanging bolts in the Inner Wall of the L-BRACKET

Fully Secure and Tighten these Bolts at each end of the Pistons.

J.) Attachment of Safety Latches.

Upon completion of Step I above, ensure the entire structure of Bed Frame to Cabinet is fully and securely attached as ONE UNIT – affix the Safety Latches.

These Latches are to be reachable by Adults Only. Thus, the minimum height shall be no less than 5feet (1.5m) from ground.

K.) POSITIONING THE MURPHY BED INTO ITS FINAL POSITION.

At this juncture, the Murphy Bed is ASSEMBLED BUT NOT AS FULL & COMPLETE piece of furniture AND NOT FUNCTIONAL AS A BED YET, as it is NOT SECURED TO THE WALL.

DO NOT ATTEMPT TO OPEN THE MURPHY BED AND OR TEST SLEEP AND OR LIE-INTO the Murphy Bed.

ALL 4 (four) adults shall now move the entire Murphy Bed to the FINAL DESIGNATED Position, matching to the previously marked “SCREW-IN” positions in the walls.

L) ATTACHMENT OF MURPHY BED TO WALL.

With the Murphy Bed now in its final designated spot, 2 adult persons shall continue to hold down the entire Murphy Bed.

REMINDER : FOLLOW the INSTRUCTIONS from your Professional Consultant / Contractor.

Position the Ladder (where necessary) and FULLY & SECURELY turn in the BOLTS or SCREWS into the CONCRETE WALL or WOODEN STUDS or STEEL STUDS.

SEQ	Bed Description	Bed Size	Details.
1	Single/Twin(XL)	~38*75/80~ inches	Attach at least 2 pieces of L or Z Hardware onto the Wall or Studs;
2	Full	54*75inches	Install at least 3 pieces of L or Z Hardware onto the Wall or Studs;
3	Queen	60*80inches	Install at least 3 pieces of L or Z Hardware onto the Wall or Studs;
4	King	76*80inches	Install at least 4 pieces of L or Z Hardware onto the Wall or Studs;
5	Other Bed Size		Other Bed Sizes - seek advice from your Contractor

Recommended Mattress weight (50.5)lbs or (23)kg / Recommended Mattress thickness (9.8)in or (25)cm - Your Murphy Bed is made having taken into consideration the Bed Frame Weight and Mattress weight to pair with the Pistons Newton Force.

Therefore, load your bed with the RECOMMENDED MATTRESS Weights, Size and Thickness as stated here in the assembly instructions.

DO NOT LOAD any heavier and or LARGER and or LIGHTER Mattress than what is recommended here. _____

M.) MATTRESS PLACEMENT .

Only after the Murphy Bed is FULLY SECURED to the wall, the 2 adult persons who are holding down the entire Murphy Bed, can now be released for this action.

Have 1 to 2 persons – place equal strengths to the handles and gently and securely, PULL DOWN the Bed Frame until the Bed Frame is horizontally and level to the ground.

Have the other 2 persons – carry and place the Mattress (within the recommended weight and thickness) and gently place the Mattress on to the Bed Frame.

N) PISTON NEWTON-LOAD STRENGTH.

You are hereby reminded that when the BED FRAME is EMPTY OF MATTRESS, the Bed Frame may NEED a STRONGER force to be pulled down before you can place the Mattress.

This RESISTANCE to be PULLED DOWN is a normal characteristics of the Pistons Newton-Load force is “in action”.

O) BED STRAP – GUIDE STRAP

Your Murphy Bed may or may not come equipped with a Bed Strap.

This Bed Strap serves as a GUIDE STRAP to help you lift the Bed Frame some 6 inches or so off its resting position. Then use both hands to FULLY LIFT HOIST the Bed Frame to its closing position.

SAFETY REMINDER :

1.) DO NOT USE THE BED STRAP to PULLDOWN TO OPEN the BED FRAME from its CLOSED POSITION.
2.) DO NOT USE THE BED STRAP to PULL-LIFT-HOIST the BED FRAME from the OPENED-HORIZONTAL position, to the CLOSED POSITION.

Both the above may cause injury and or unnecessary strain to your arm(s).

P.) USING YOUR MURPHY BED.

For EVERYUSE – exercising Safety Precautionary Measures to ensure the safety of your family members and pets are IMPORTANT.

Therefore, PRIOR TO OPENING / PRIOR TO CLOSING OF YOUR MURPHY BED - Make sure all Children / Non Ambulatory Persons and Pets are at bay.

KEEP CHILDREN and NON-AMBULATORY persons from Unlatching the Safety Latches.

Q.) CAUTION : DO NOT BE DISTRACTED During EVERYOPENING and CLOSING of your Murphy Bed.

Every time you Pull to OPEN the Murphy Bed from its closed position OR Lift-Pull to CLOSE the Murphy Bed to stow it into the Bed Cabinet -

give these actions your focused and dedicated attention.

DURING EVERYOPENING and CLOSING of your Murphy Bed - always ensure you have an Adult Partner close by for added assistance, where necessary.

DO NOT OVER EXERT ADDED FORCE to OPEN the Bed or to CLOSE the Bedframe. For if you do, the resistance of the Piston will only make it harder for you to complete the task.

TO CLOSE the Murphy Bed : depending on your height – stand some 6 inches to 10 inches away from the FootBoard edge. Use both your hands and place both hands at about equal distance from the middle of the Bed Frame, spaced at 2 to 3 feet between your hands - GENTLY LIFT-PULL to Close your Murphy Bed.

TO OPEN the Murphy Bed : using equal force – place your hands to the installed grab handle and GENTLY PULL towards you to Open. As you pull Open the Murphy Bed – proceed to move backwards, slowly and steadily, so as to give way to the Murphy Bed's OPEN Position.

During EVERYOPENING or CLOSING of the Murphy Bed - at about your hip level - you may find that you need to rotate your hand / wrist - take caution here to prevent injury. During EVERYOPENING and CLOSING, keep Children and Pets and Non Ambulatory Persons at bay.

NEVER allow your children to treat this Murphy Bed as a Hide and Seek place of fun or jump on the bed.

Care & Maintenance - Depending on the frequency of use of your Murphy Bed, it is recommended that you take precautionary Care and Maintenance. It is advisable to conduct NO LESS THAN 2 to 3 checks annually on these mounting points & pistons to ensure that these are securely bolted. Where necessary, use a vacuum cleaner to clear all dust and then wipe down with a damp cloth, then proceed with your maintenance work.

Safety Latches - Your Murphy Bed comes with two (2) Safety Latches. These are to be attached at, both the TOP LEFT and TOP RIGHT hand upper portion, minimum of 5 feet (1.5m) from ground, of the Bed Frame / Bed Cabinet. Monitor and Inspect these frequently.

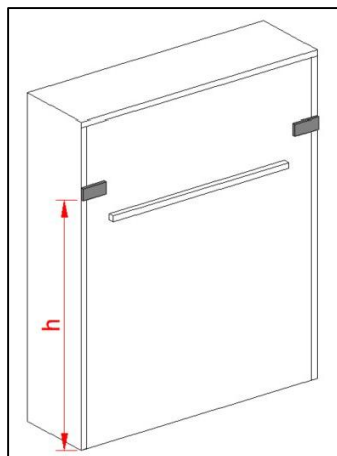

Whenever NOT in use and after the Murphy Bed has been LIFTED and stowed in its CLOSED POSITION - ALWAYS LATCH UP.

Frequently Asked Questions.

Malfunctioned Pistons.

How do you know when the Murphy Bed's Piston has malfunctioned?

It would be quite evident in that :

- a.) the Bed Frame may become LOPSIDED and
- b.) the Lift-PULL force to CLOSE may be "heavier" than before.

IMMEDIATELY - STOP USING YOUR MURPHY BED.

SEEK and CONSULT professional maintenance service to ascertain the problem and repair and or have the pistons changed.

Assembly Instructions / Instructions de montage

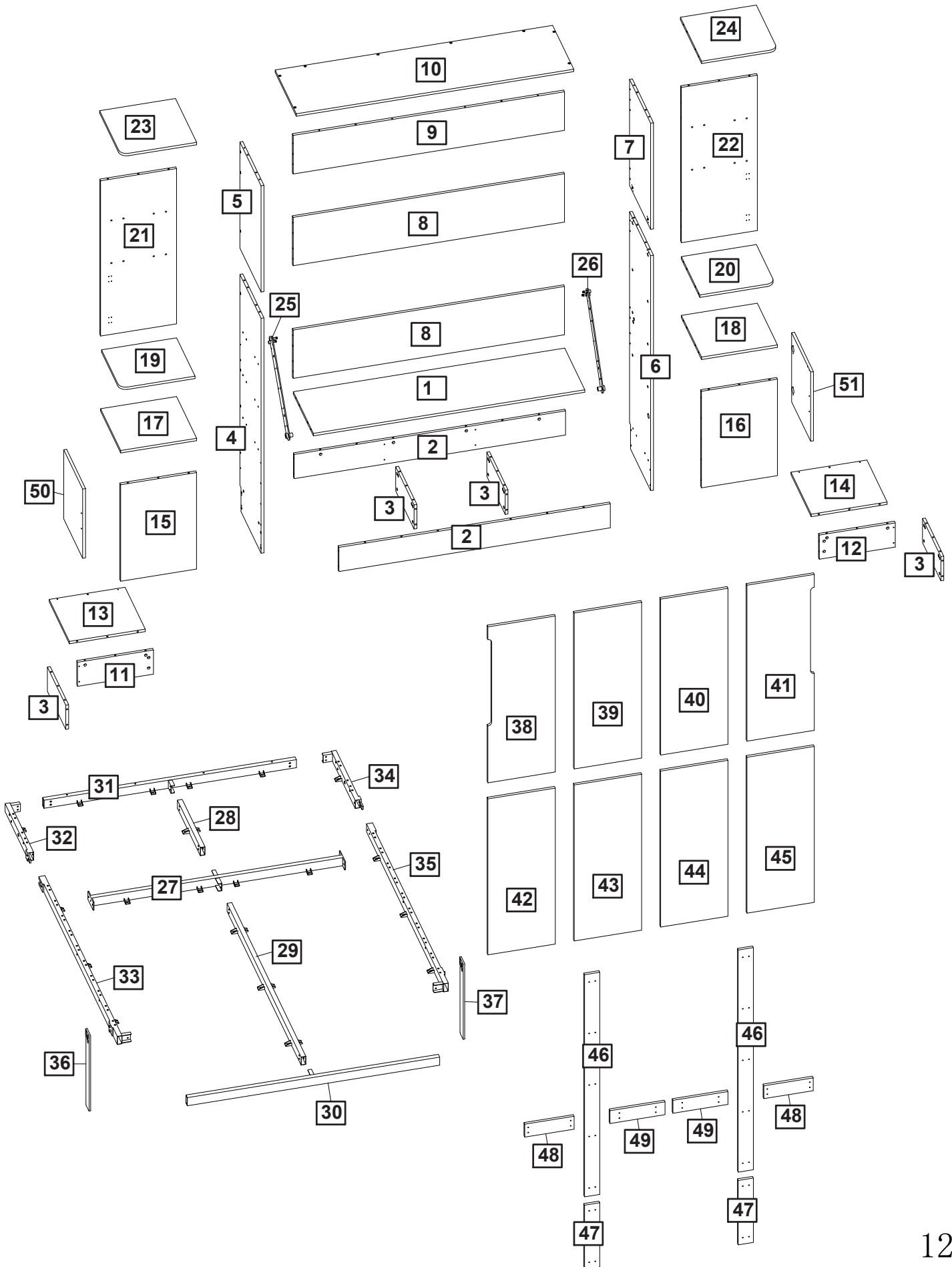

Part List:

Liste des pièces:

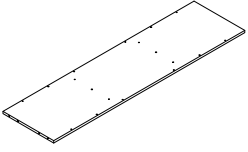
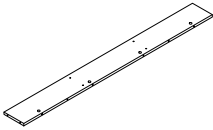
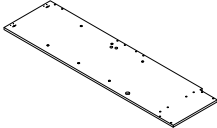
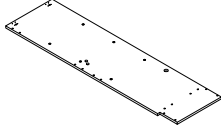
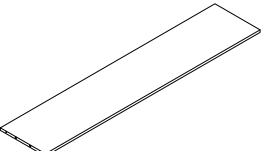
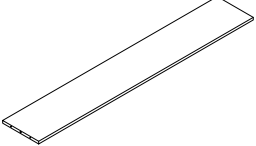
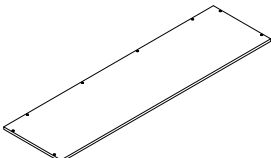
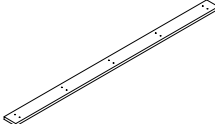
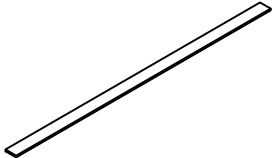
 1 PC	 2 PCS	 1 PC	 1 PC	 2 PCS
 1 PC	 1 PC	 2 PCS	 12 PCS	

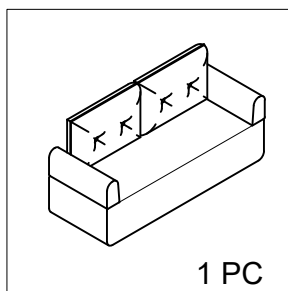

Part List:

Liste des pièces:

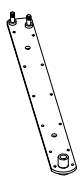

Part List:

Liste des pièces:

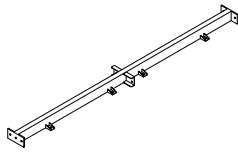
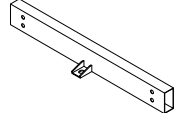
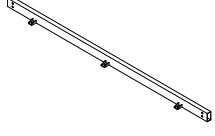
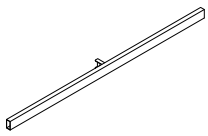
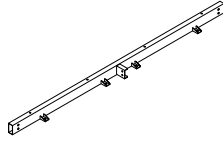
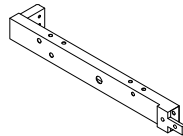
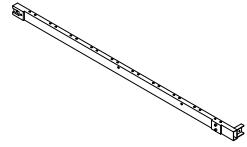
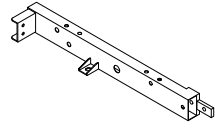
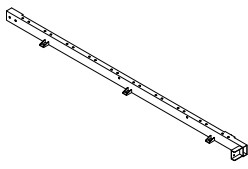
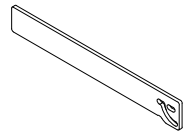
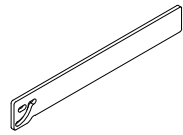
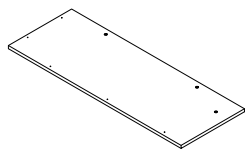
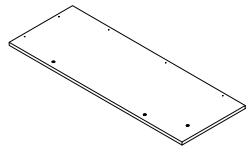
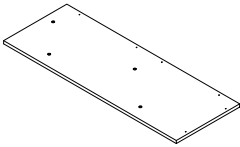
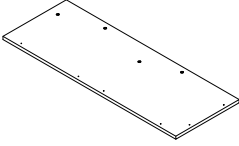
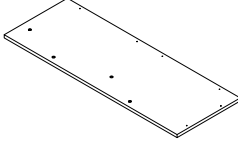
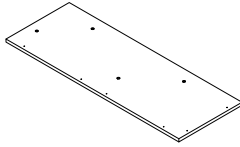
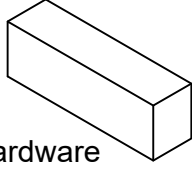
<p>25</p>  <p>1 PC</p>	<p>26</p>  <p>1 PC</p>	<p>27</p>  <p>1 PC</p>	<p>28</p>  <p>1 PC</p>	<p>29</p>  <p>1 PC</p>
<p>30</p>  <p>1 PC</p>	<p>31</p>  <p>1 PC</p>	<p>32</p>  <p>1 PC</p>	<p>33</p>  <p>1 PC</p>	<p>34</p>  <p>1 PC</p>
<p>35</p>  <p>1 PC</p>	<p>36</p>  <p>1 PC</p>	<p>37</p>  <p>1 PC</p>	<p>39</p>  <p>1 PC</p>	<p>40</p>  <p>1 PC</p>
<p>42</p>  <p>1 PC</p>	<p>43</p>  <p>1 PC</p>	<p>44</p>  <p>1 PC</p>	<p>45</p>  <p>1 PC</p>	<p>Hardware</p>  <p>1 PC</p>

Part List:

Liste des pièces:

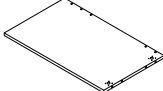
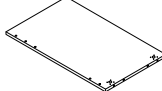
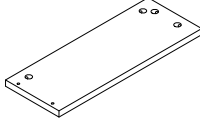
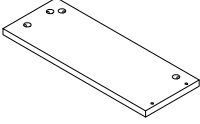
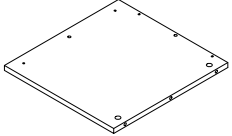
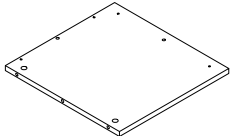
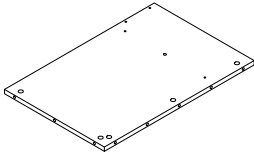
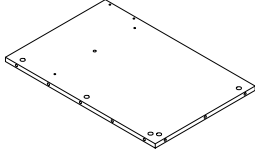
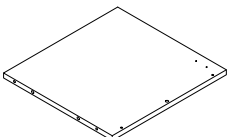
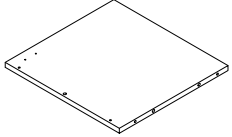
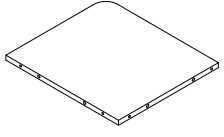
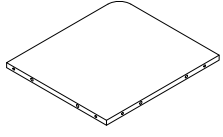
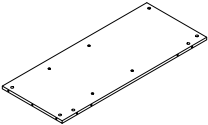
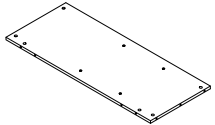
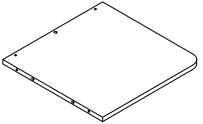
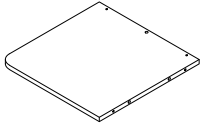
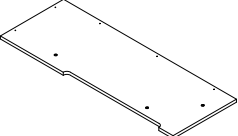
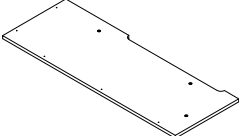
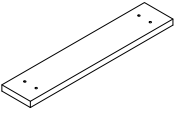
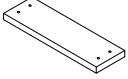
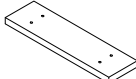
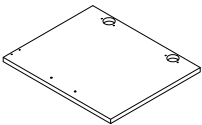
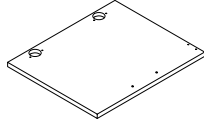
<p>③</p>  <p>4 PCS</p>	<p>⑤</p>  <p>1 PC</p>	<p>⑦</p>  <p>1 PC</p>	<p>⑪</p>  <p>1 PC</p>	<p>⑫</p>  <p>1 PC</p>
<p>⑬</p>  <p>1 PC</p>	<p>⑭</p>  <p>1 PC</p>	<p>⑮</p>  <p>1 PC</p>	<p>⑯</p>  <p>1 PC</p>	<p>⑰</p>  <p>1 PC</p>
<p>⑱</p>  <p>1 PC</p>	<p>⑲</p>  <p>1 PC</p>	<p>⑳</p>  <p>1 PC</p>	<p>㉑</p>  <p>1 PC</p>	<p>㉒</p>  <p>1 PC</p>
<p>㉓</p>  <p>1 PC</p>	<p>㉔</p>  <p>1 PC</p>	<p>㉘</p>  <p>1 PC</p>	<p>㉙</p>  <p>1 PC</p>	<p>㉚</p>  <p>2 PCS</p>
<p>④⑧</p>  <p>2 PCS</p>	<p>④⑨</p>  <p>2 PCS</p>	<p>⑤①</p>  <p>1 PC</p>	<p>⑤②</p>  <p>1 PC</p>	

Using Camlocks

Step 1

Connect the male camlock as directed in the assembly instructions using a screwdriver.

1

DO NOT OVER TIGHTEN.
NE PAS SERRER EXCESSIVEMENT.

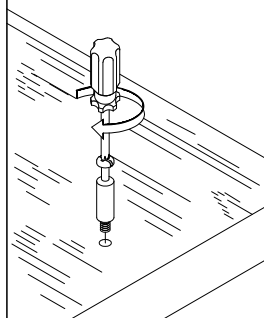

Step 2

Push the male camlock into the entry hole.

2

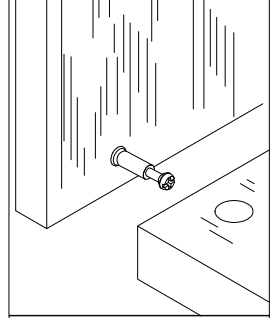

Step 3

Insert the female camlock as shown in the instruction.

Note: ensure that the arrow on the top of the camlock points towards the entry hole for the male camlock.

3

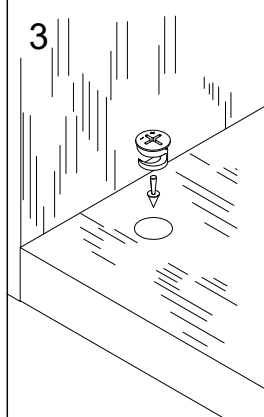

Step 4

Turn the female camlock clockwise with a screwdriver.

You should feel a click when the camlock is locked in place.

The joint is now secure.

4

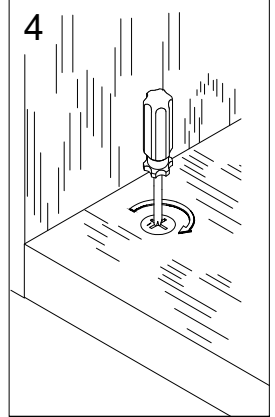

Utilisation de Camlocks

1

Connectez le mâle Camlock tel que dicté dans Les instructions de montage Utiliser un driver scewdriver.

1

Ne pas trop serrer.
NE PAS SERRER EXCESSIVEMENT.

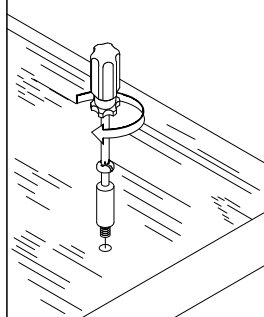

2

Poussez le camlock mâle Dans le trou d'entrée.

2

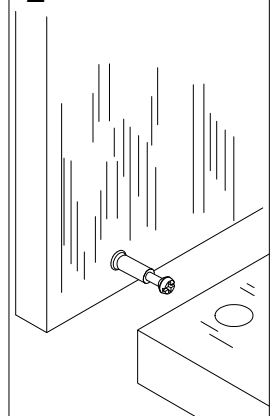

3

Insérer le femle Camlock comme indiqué dans le Instruction.

Note: assurez-vous que le Flèche sur le haut de la Camlock pointe vers Le trou d'entrée pour la Mâle camlock.

3

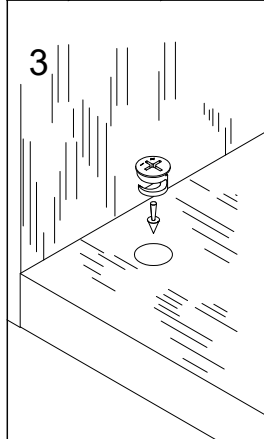

4

Tournez la femelle camlock Dans le sens horaire avec un Tournevis.



Vous devriez sentir un clic Lorsque le camlock est Verrouillé en place.

Le joint est maintenant sécurisé.

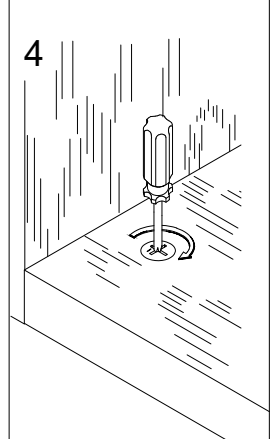
4



Hardware List / Liste du matériel:

<p>A </p> <p>Male Camlock x 66 Mâle Camlock</p>	<p>B </p> <p>Female Camlock x 70 Femelle Camlock</p>	<p>C </p> <p>Dowel x 74 Le goujon</p>
<p>D </p> <p>6.8*48mm Screw x 52 6*48mm vis</p>	<p>E </p> <p>Hex Key M4 x 1 Clé hexagonale M4</p>	<p>F </p> <p>Magnetic bump x 2 Bosse magnétique</p>
<p>G </p> <p>Angle code x 3 Code la corne de l'afrique</p>	<p>H </p> <p>MATTRESS SUPPORT x 2 SUPPORT de matelas</p>	<p>I </p> <p>4*50mm Screw x 6 4*50mm vis</p>
<p>J </p> <p>4*16mm Screw x 24 4*16mm vis</p>	<p>K </p> <p>4*30mm Screw x 44 4*30mm vis</p>	<p>L </p> <p>Ø20 Sticker x 60 Ø20 autocollant</p>
<p>M </p> <p>Webbing x 2 Sangle de sangle</p>	<p>N </p> <p>Nylon washer (19*1.5) x 4 Rondelle en Nylon (19*1.5)</p>	<p>O </p> <p>Nut M8 x 8 Écrou M8</p>
<p>P </p> <p>Wrench x 1 Clé à clé</p>	<p>Q </p> <p>6*12mm Screw x 4 6*12mm vis</p>	<p>R </p> <p>Positioning pin x 2 Fiche fixe -in</p>
<p>S </p> <p>Cylinder x 4 Barre pneumatique</p>	<p>T </p> <p>6*12mm Screw x 44 6*12mm vis</p>	<p>U </p> <p>8*45mm Screw x 4 8*45mm vis</p>
<p>V </p> <p>6*25mm Screw x 2 6*25mm vis</p>	<p>W </p> <p>Single plastic cap x 26 Capuchon en plastique unique</p>	<p>X </p> <p>Slat x 12 Les lamelles</p>
<p>Y </p> <p>Hex Key M5 x 1 Clé hexagonale M5</p>	<p>Z </p> <p>Handle & Fixings x 2 Poignée & fixations</p>	<p>AA </p> <p>4*16mm Screw x 6 4*16mm vis</p>
<p>BB </p> <p>Nylon washer (16*1) x 12 Rondelle en Nylon (16*1)</p>	<p>CC </p> <p>Tip guard x 2 Garde de pointe</p>	<p>DD </p> <p>4*25mm Screw x 12 4*25mm vis</p>
<p>EE </p> <p>Door Hinge x 4 Charnière de porte</p>	<p>FF </p> <p>3.5*14mm Screw x 60 3.5*14mm vis</p>	<p>GG </p> <p>Connecting iron x 4 Fer de connexion</p>
<p>HH </p> <p>10*10mm Screw x 4 10*10mm vis</p>	<p>II </p> <p>6*60mm Screw x 4 6*60mm vis</p>	<p>JJ </p> <p>8*40mm Screw x 6 8*40mm vis</p>
<p>KK </p> <p>Magnet Touch x 2 Aimant toucher</p>	<p>LL </p> <p>3*16mm Screw x 4 3*16mm vis</p>	

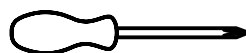

Assembly Tools Required (Not Included)
Outils d'assemblage requis (Non Inclus)

Assembly Instructions / Instructions de montage

Step 1

Étape 1

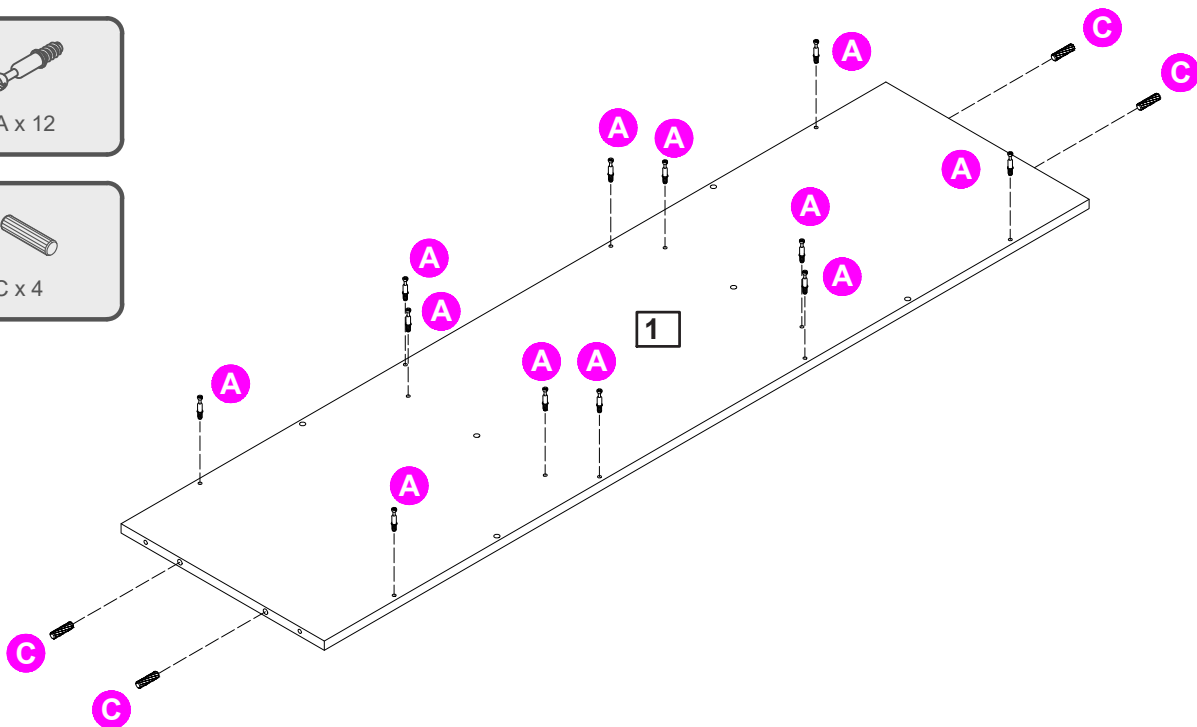
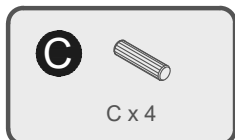

Step 2

Étape 2

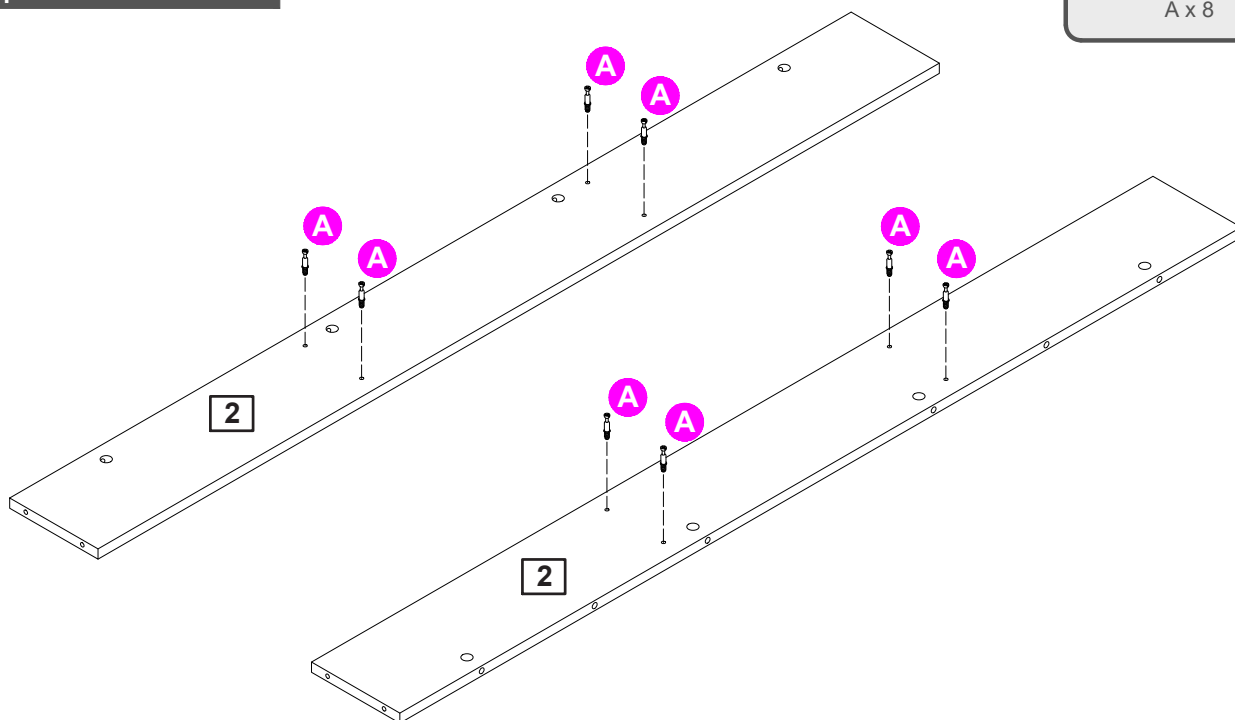
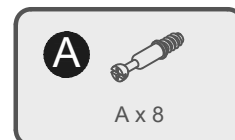

Assembly Instructions / Instructions de montage

Step 3

Étape 3

B



B x 4

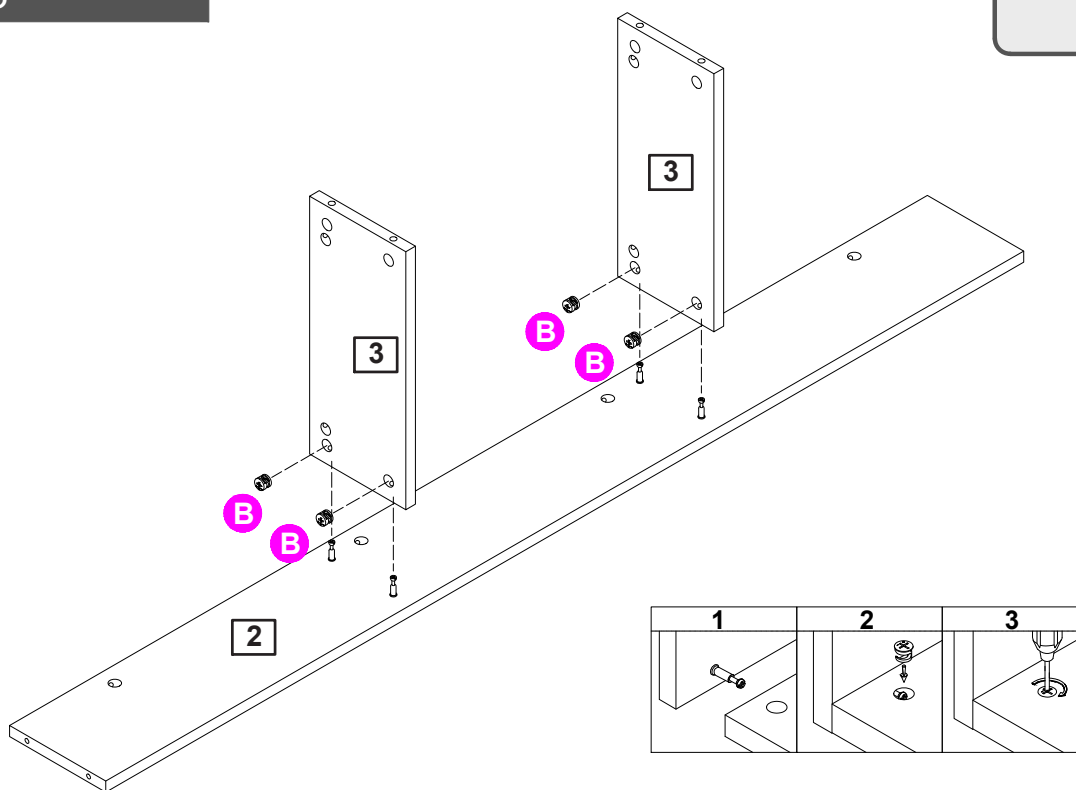

Step 4

Étape 4

B



B x 4

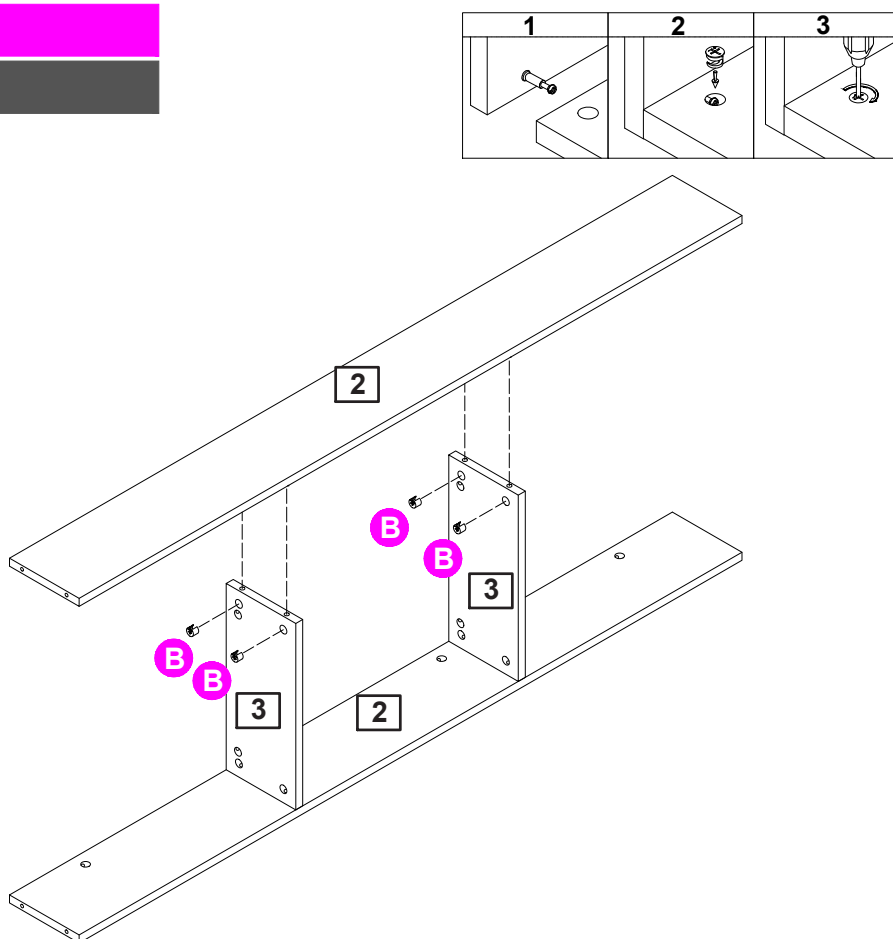

Assembly Instructions / Instructions de montage

Step 5

Étape 5

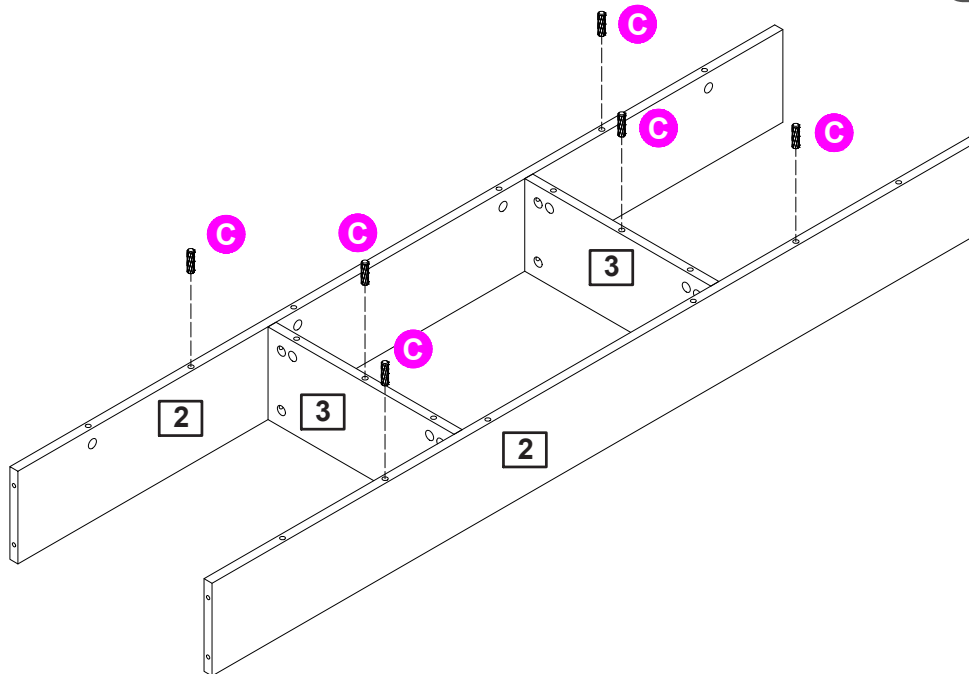

Step 6

Étape 6

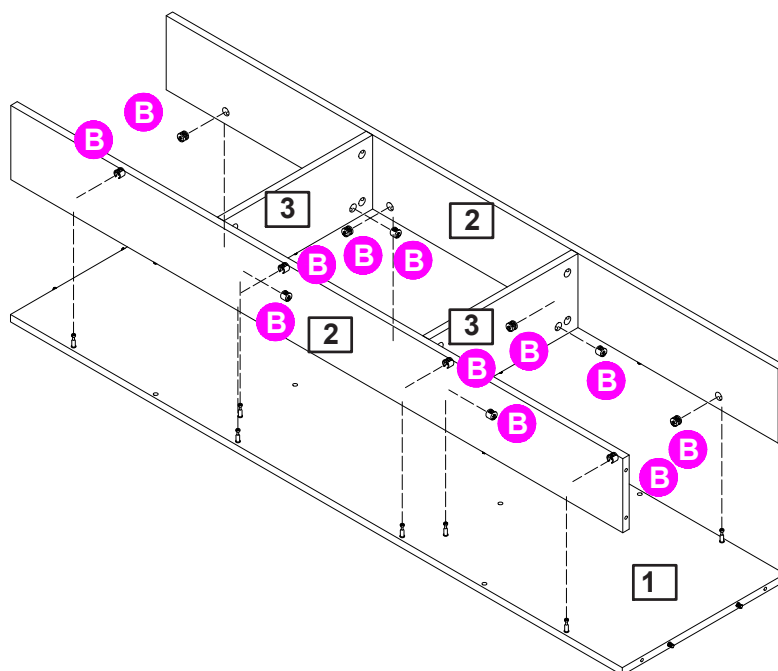
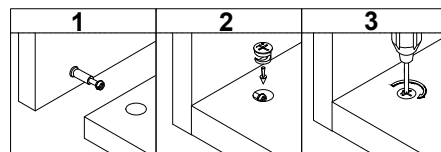

Assembly Instructions / Instructions de montage

Step 7

Étape 7

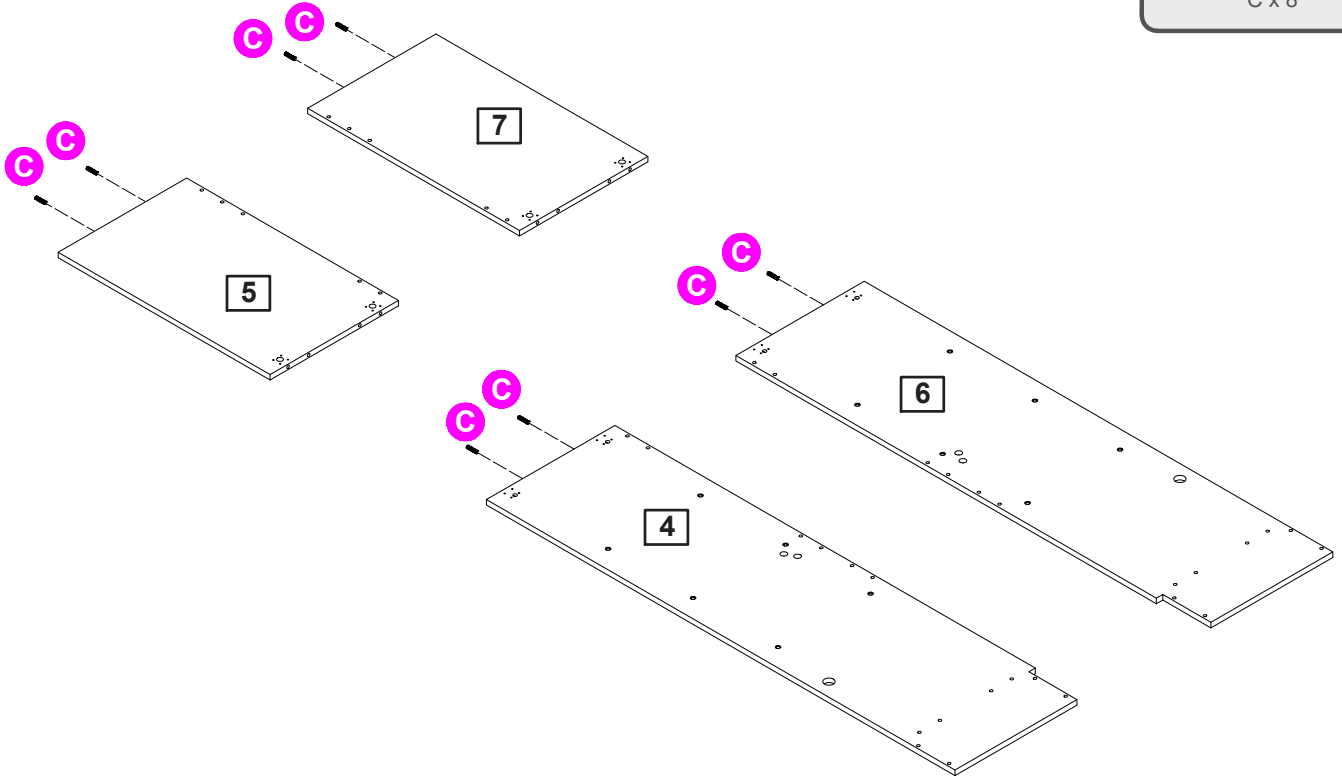

Step 8

Étape 8

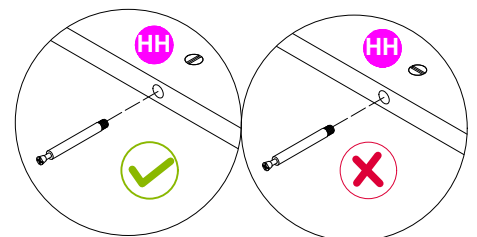
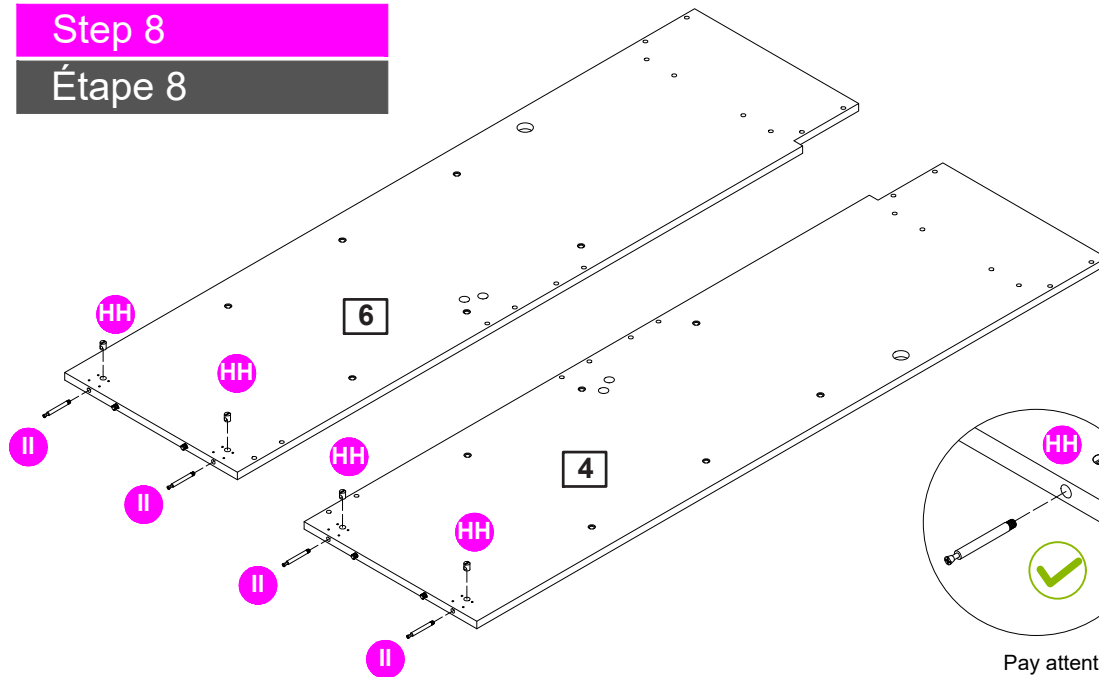

Pay attention to hardware I direction.
Pass auf die hardware auf.

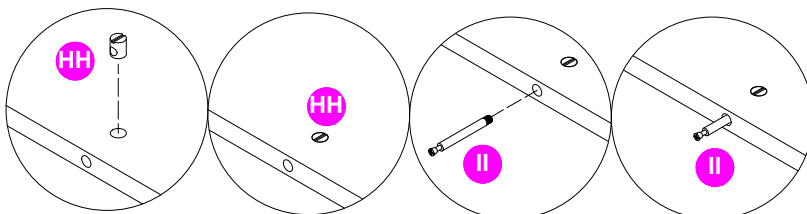

Assembly Instructions / Instructions de montage

Step 9

Étape 9

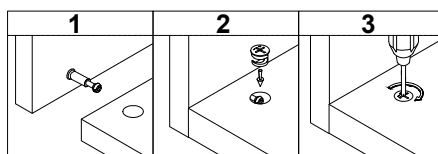

B



B x 4

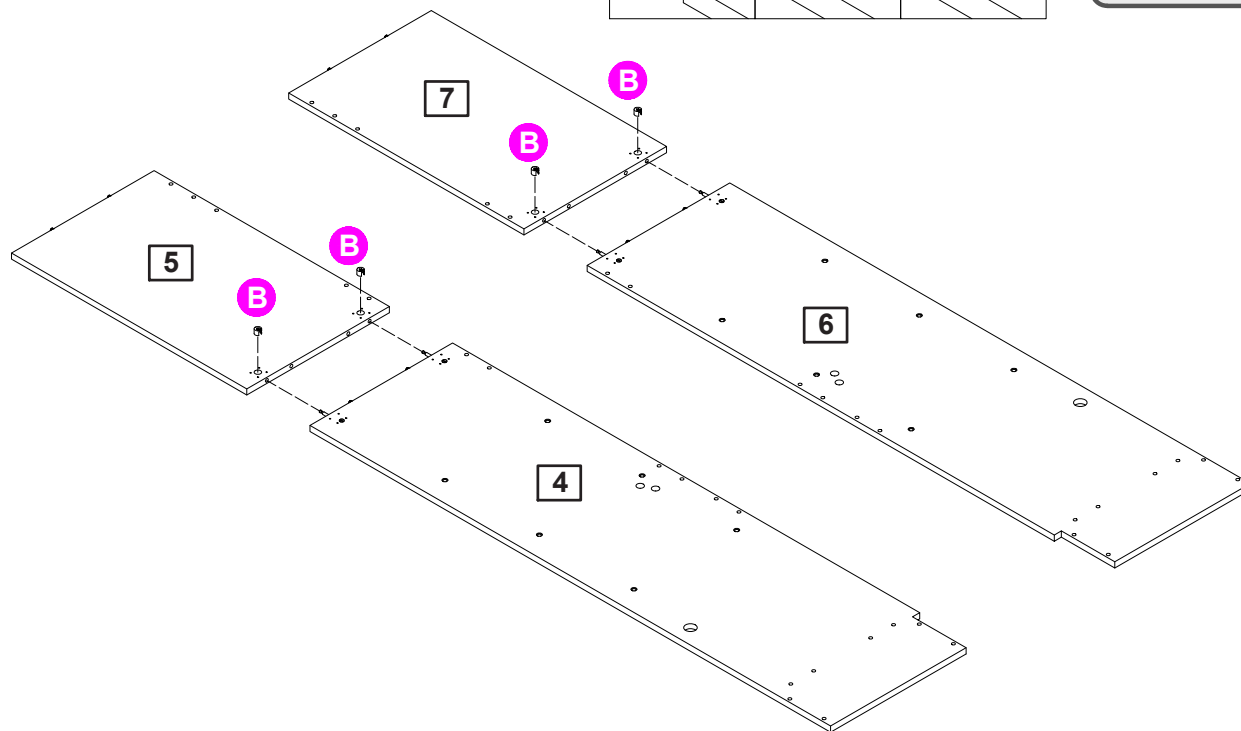

Step 10

Étape 10

FF



FF x 32

GG



GG x 4

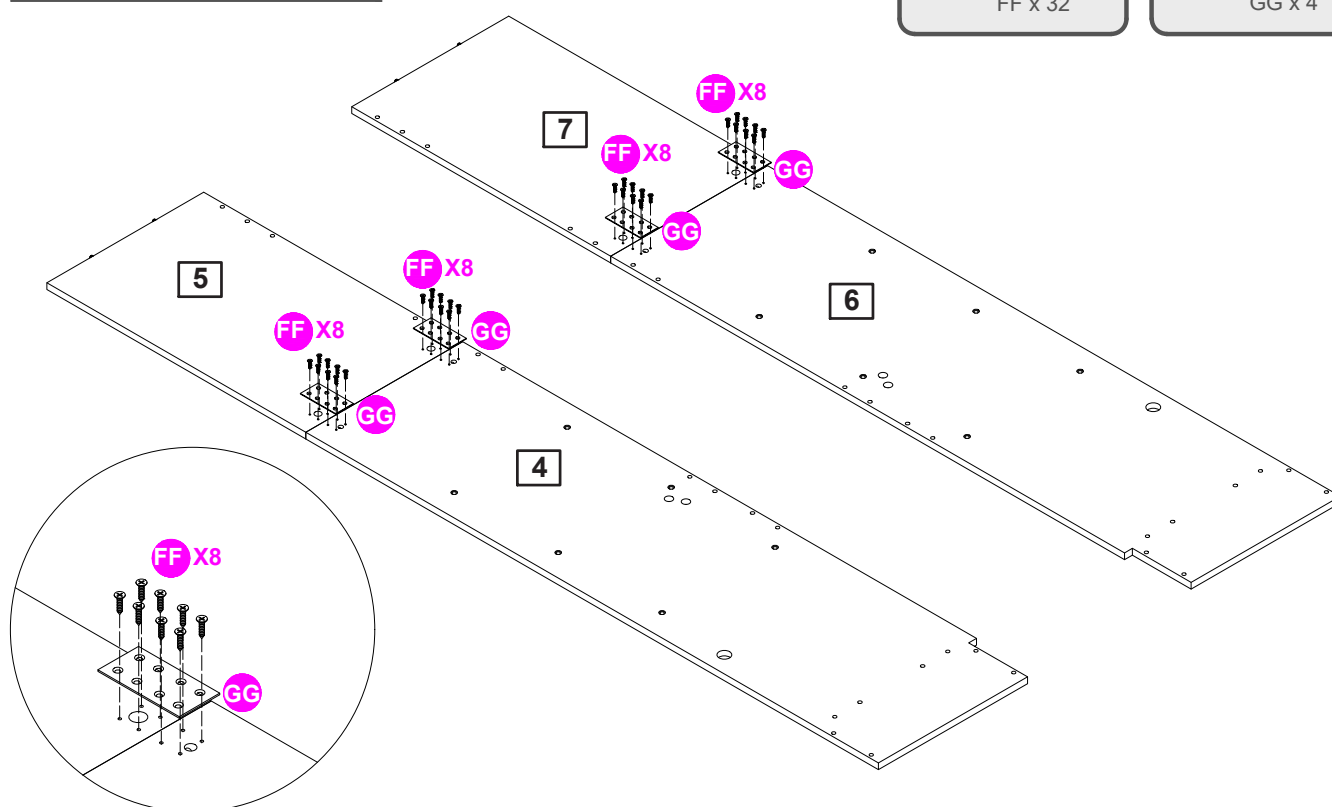

Assembly Instructions / Instructions de montage

Step 11

Étape 11

J



J x 24

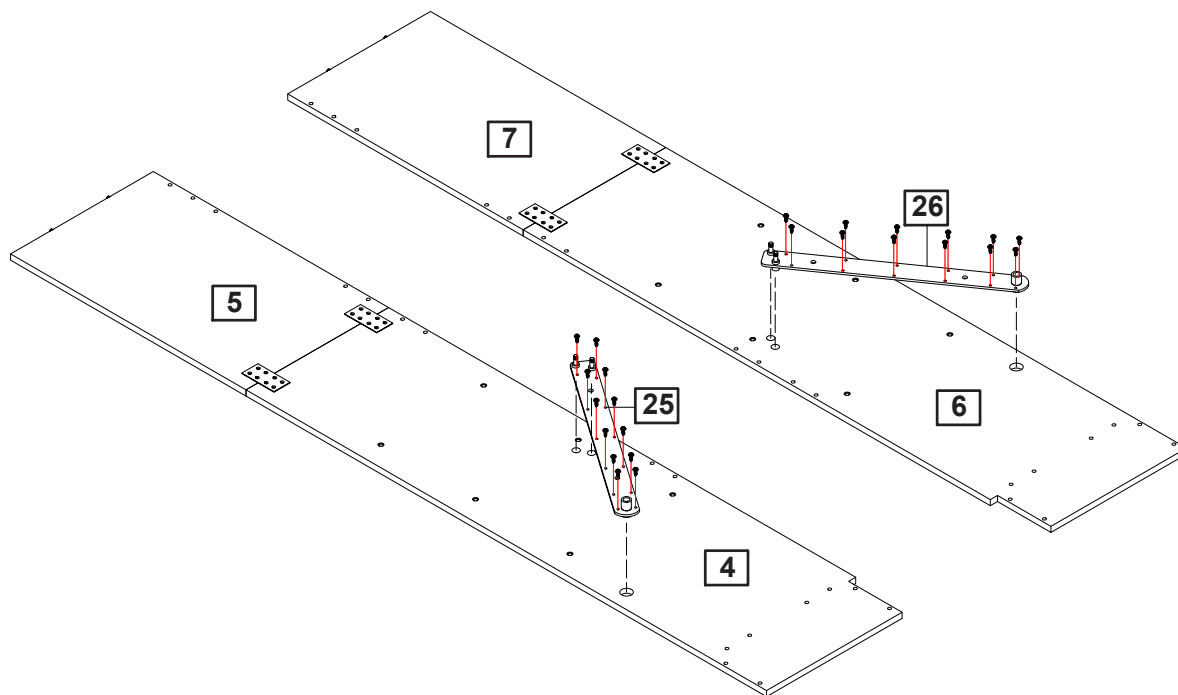

Step 12

Étape 12

C



C x 12

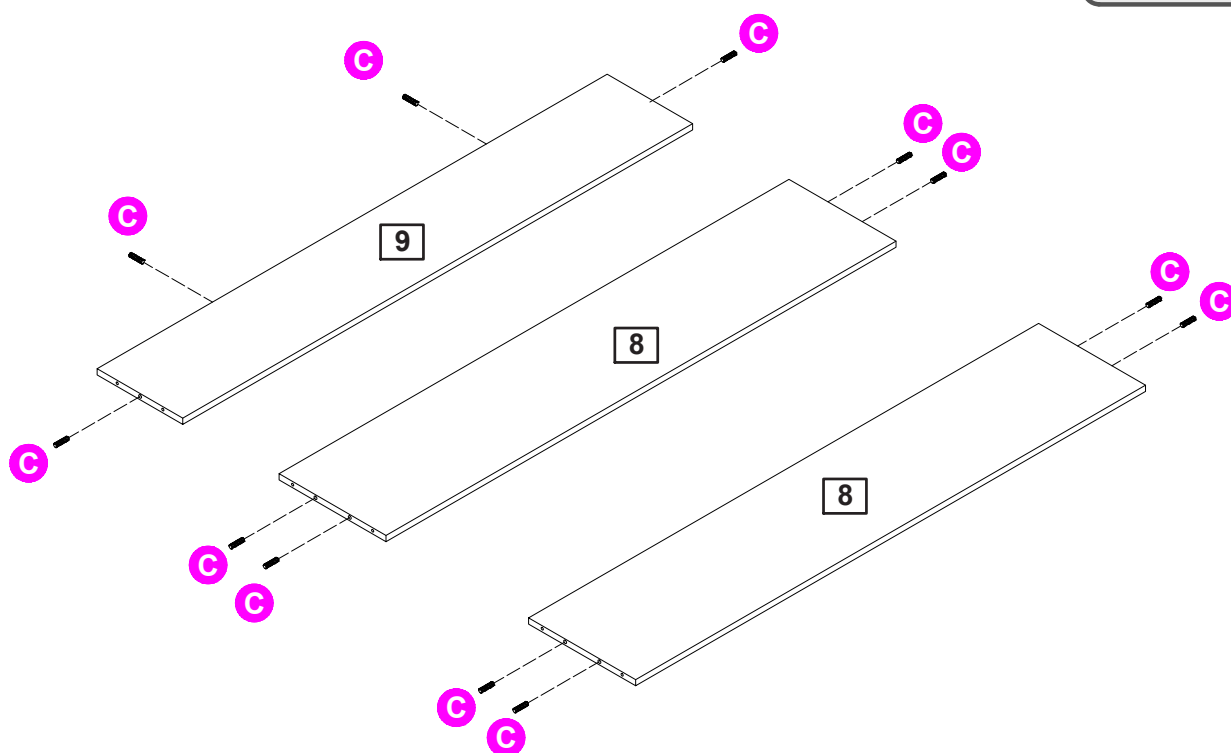

Assembly Instructions / Instructions de montage

Step 13

Étape 13

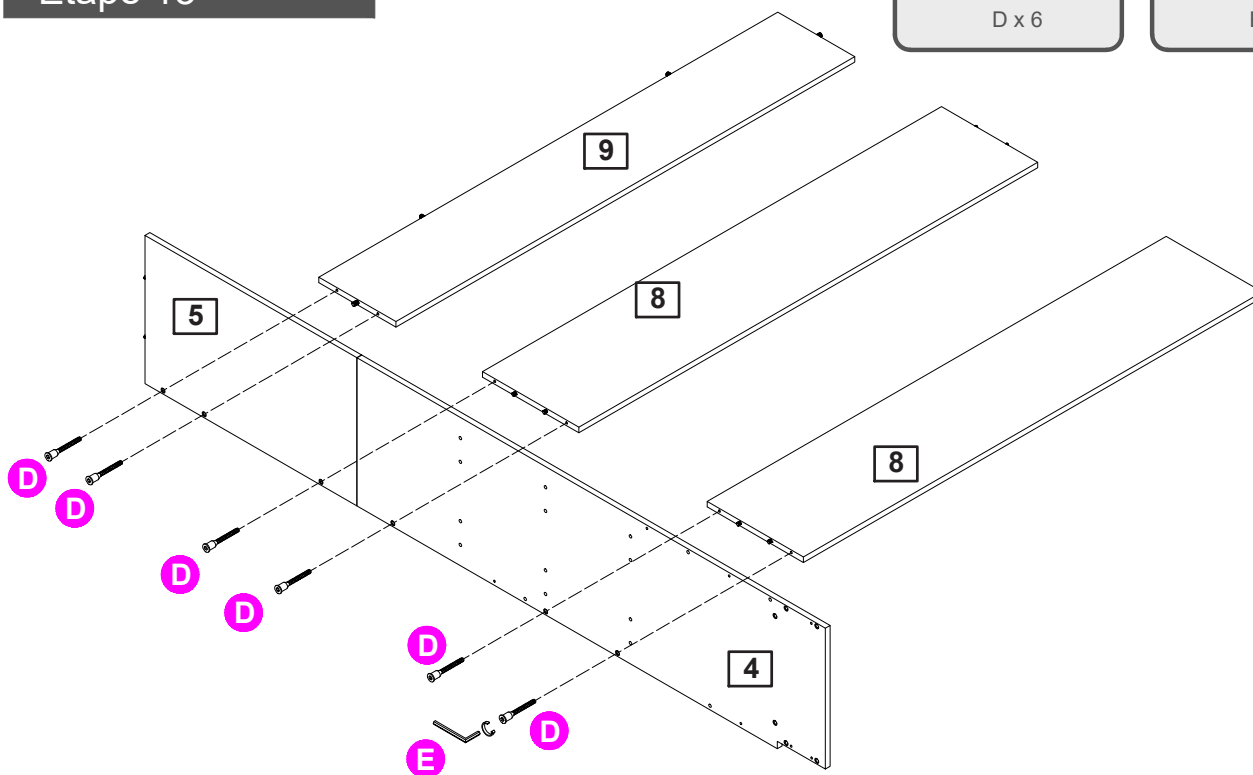
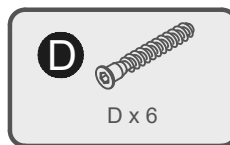

Step 14

Étape 14

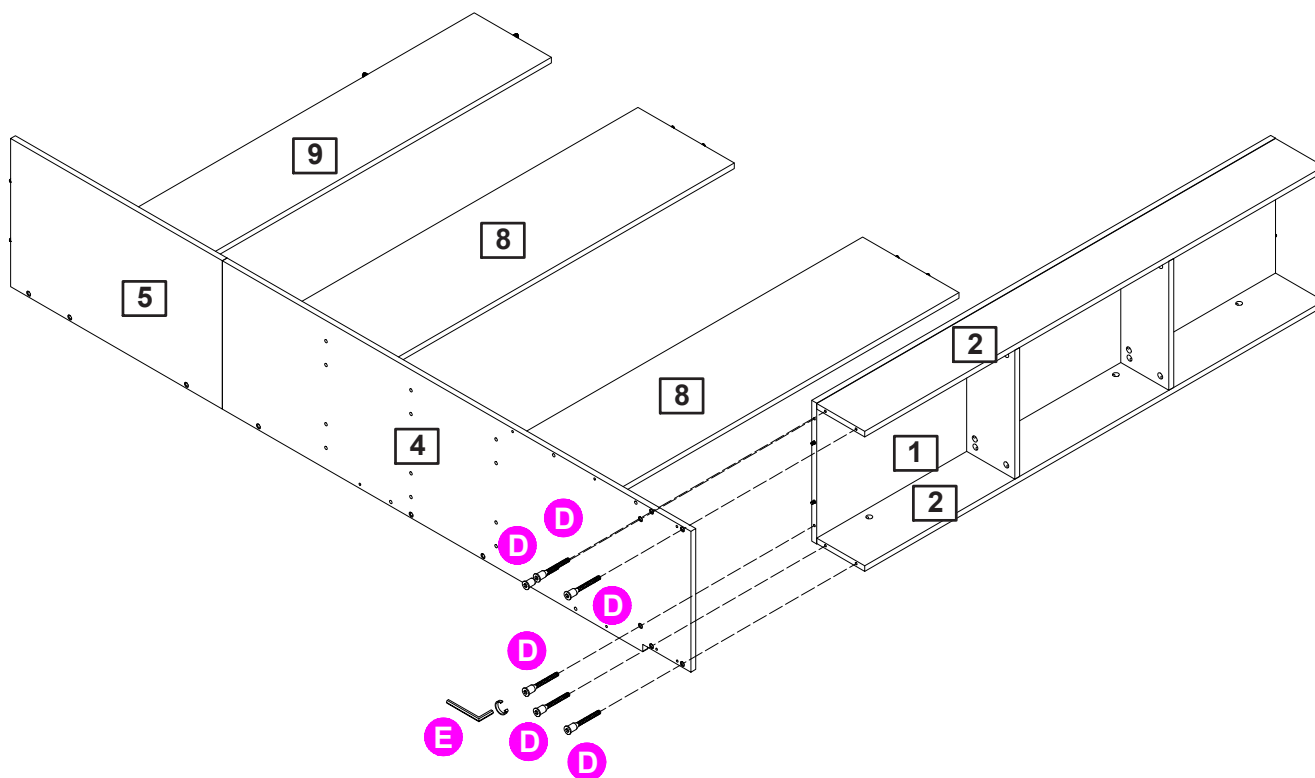

Assembly Instructions / Instructions de montage

Step 15

Étape 15

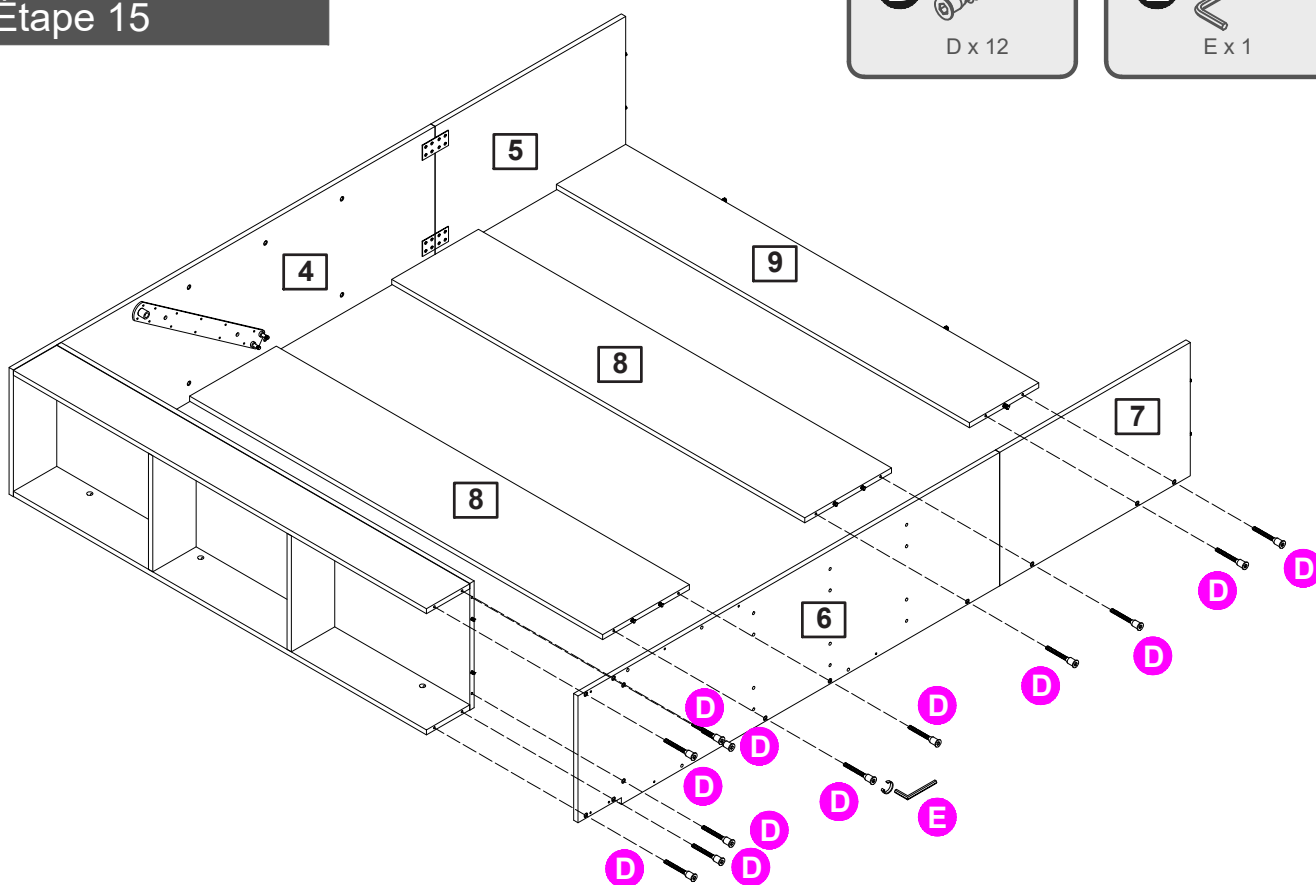

Step 16

Étape 16

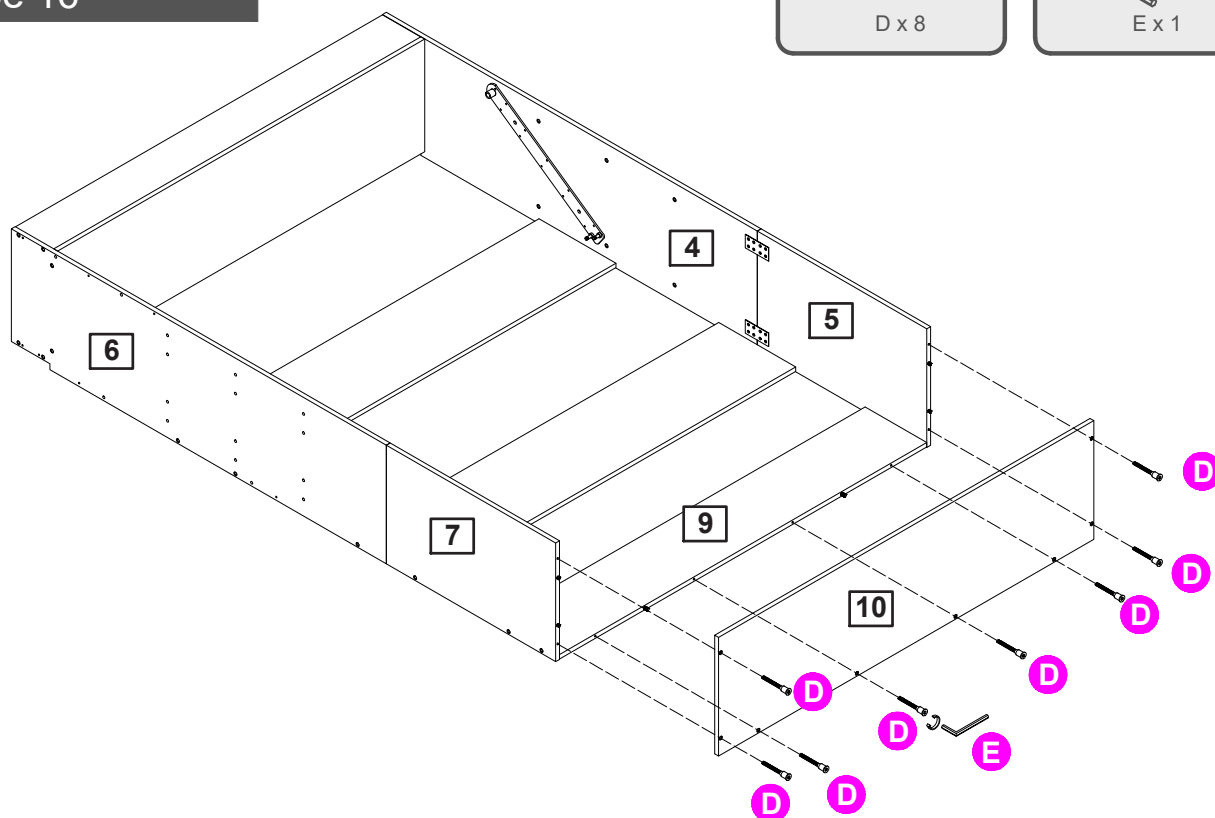

Assembly Instructions / Instructions de montage

Step 17

Étape 17

A



A x 7

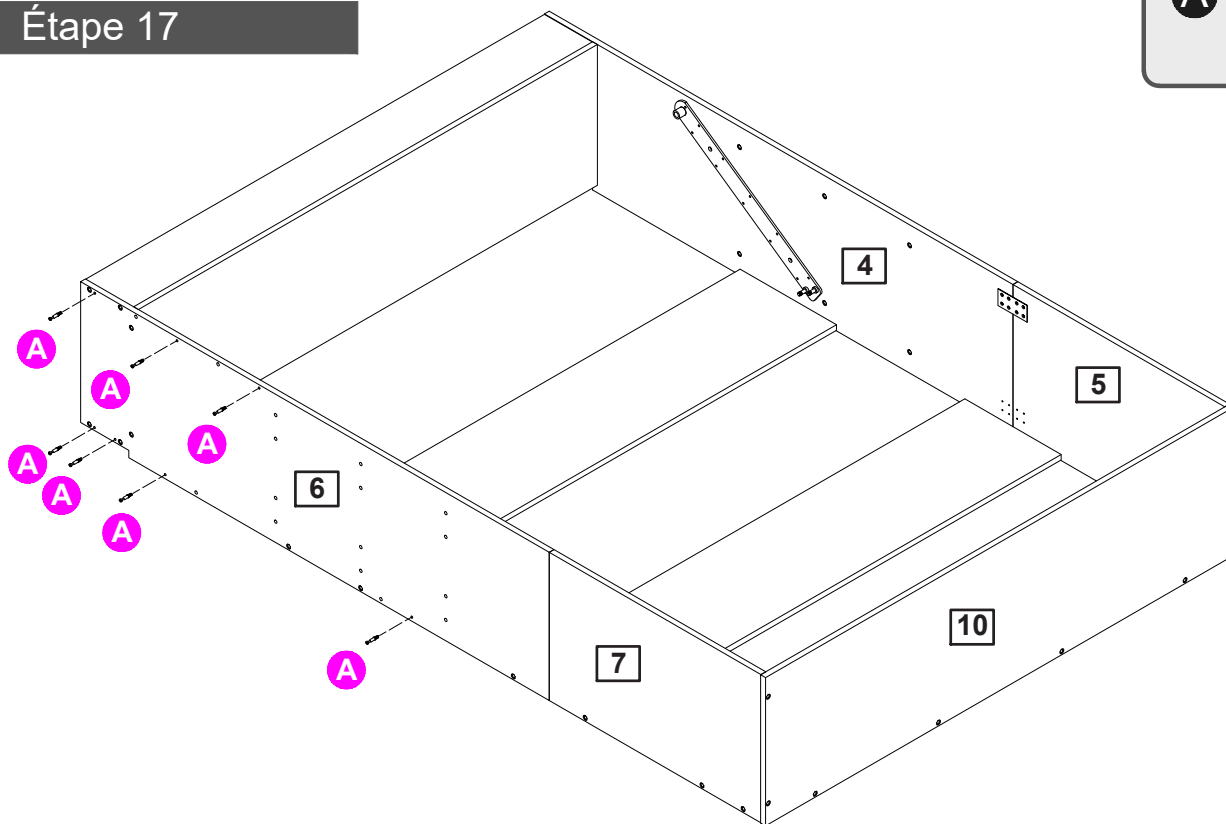

Step 18

Étape 18

A



A x 7

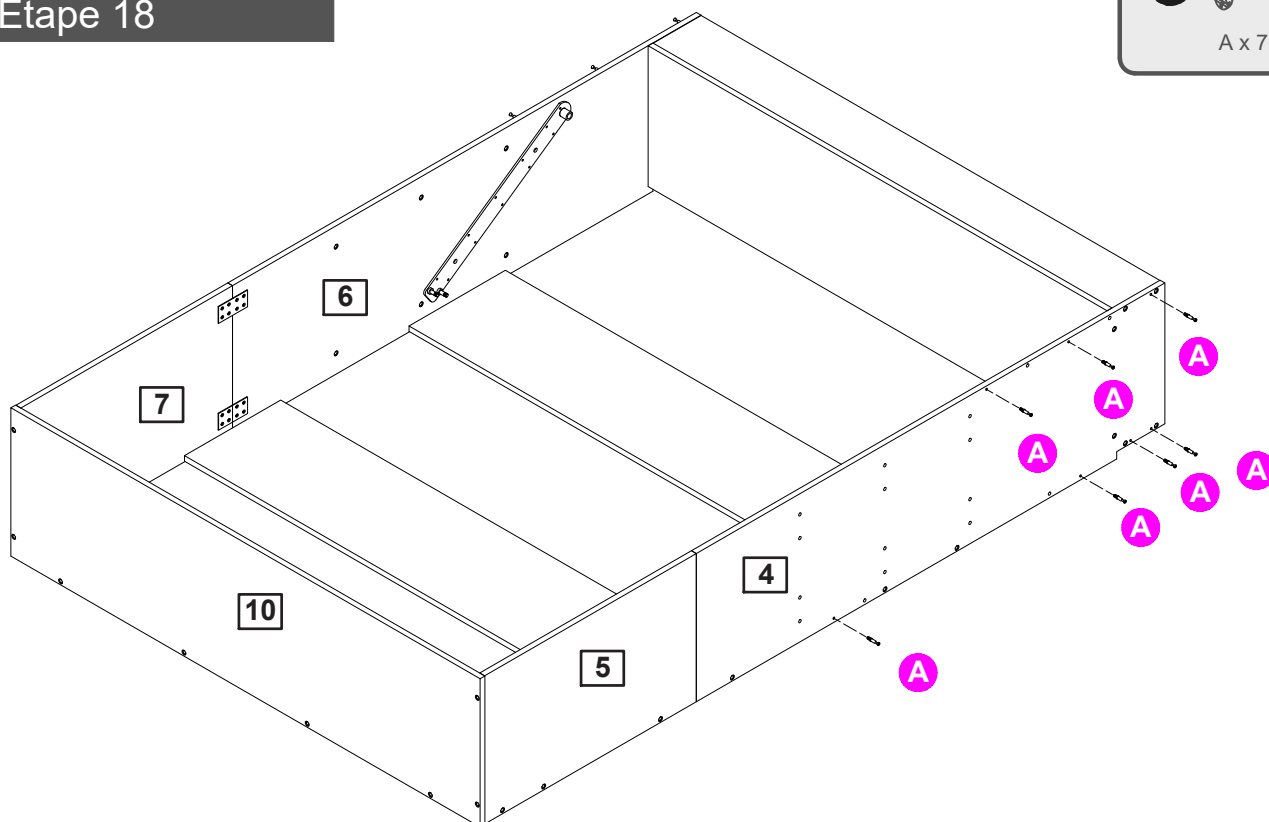

Assembly Instructions / Instructions de montage

Step 19

Étape 19



A x 4

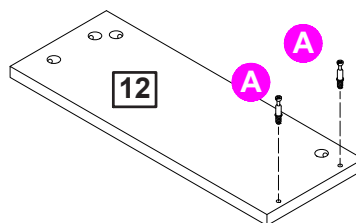
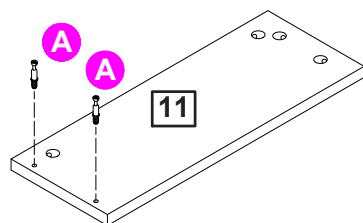

Step 20

Étape 20

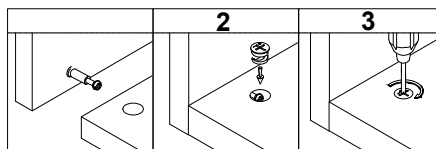

B x 4

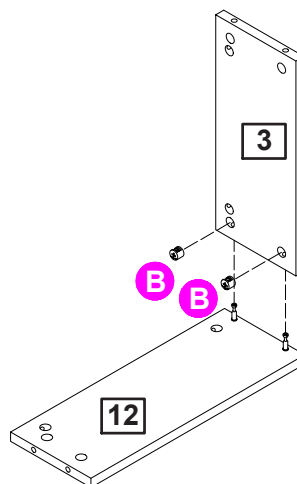
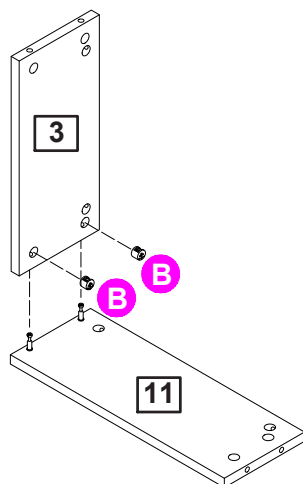

Assembly Instructions / Instructions de montage

Step 21

Étape 21

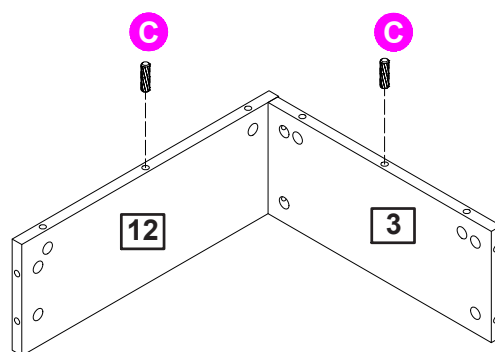
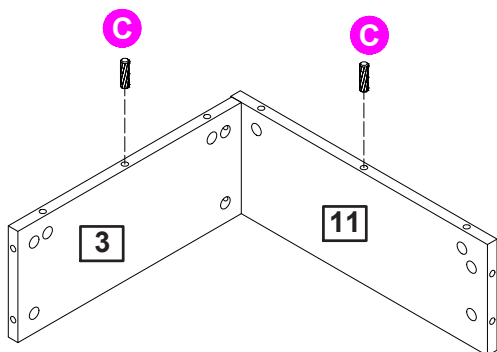

Step 22

Étape 22

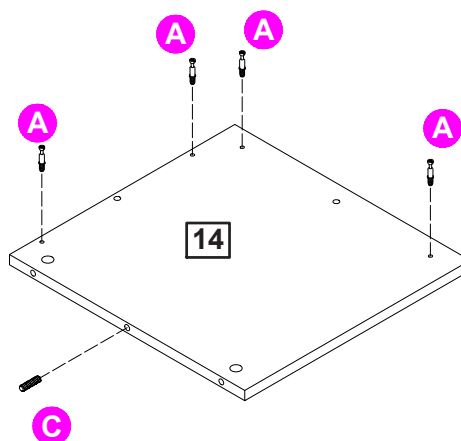
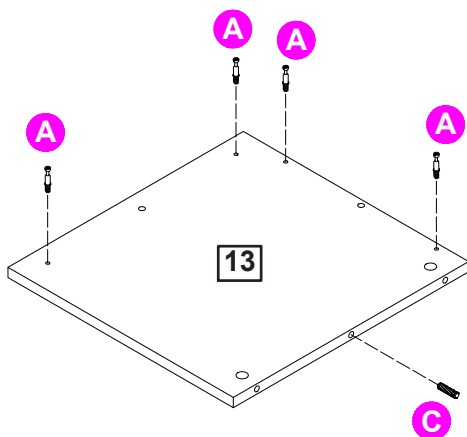

Assembly Instructions / Instructions de montage

Step 23

Étape 23

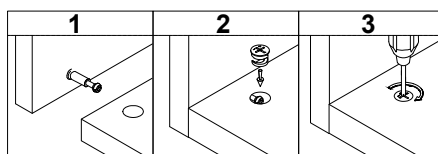

B



B x 8

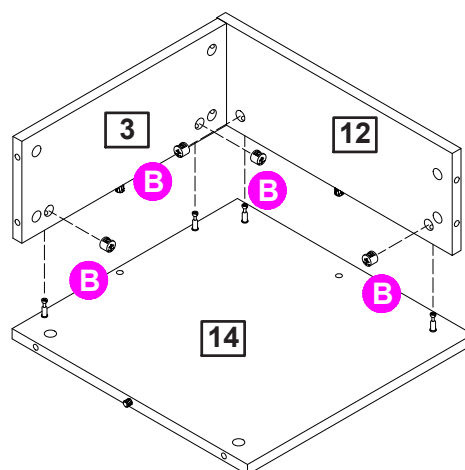
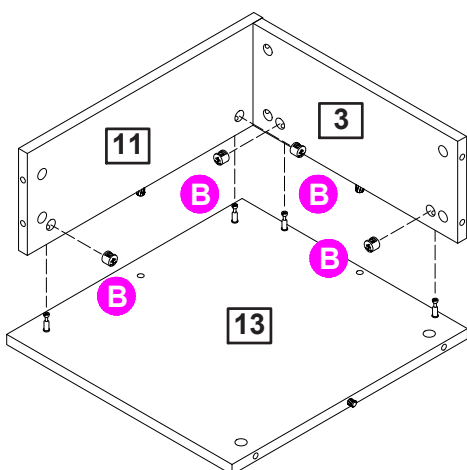

Step 24

Étape 24

A



A x 4

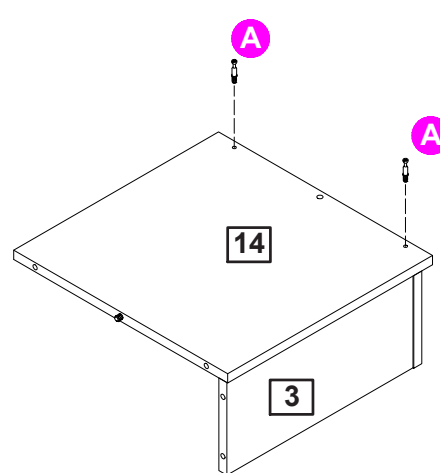
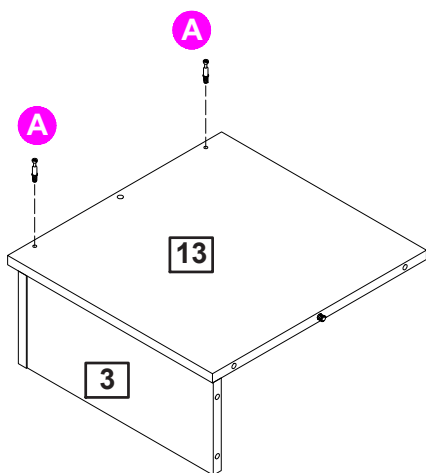

Assembly Instructions / Instructions de montage

Step 25

Étape 25

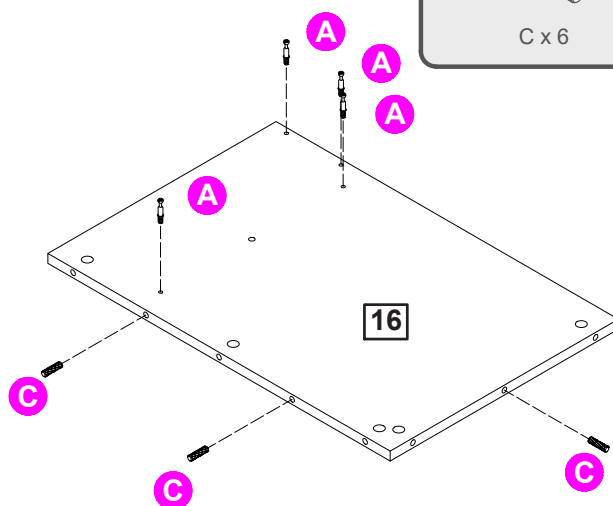
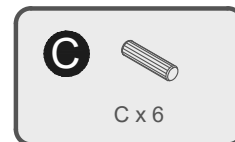
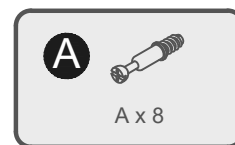
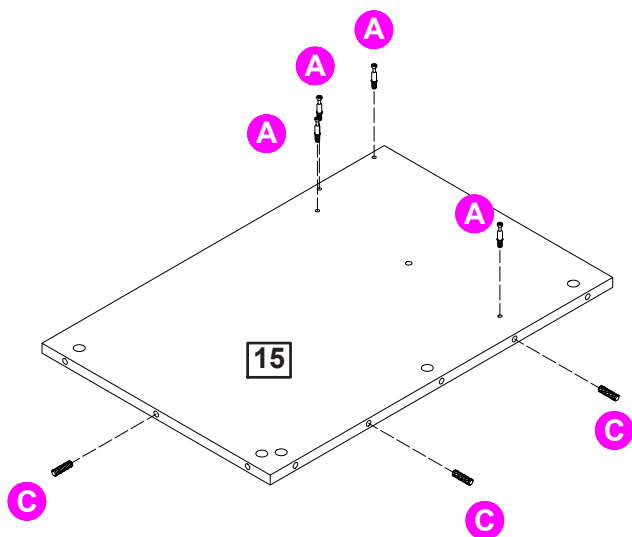

Step 26

Étape 26

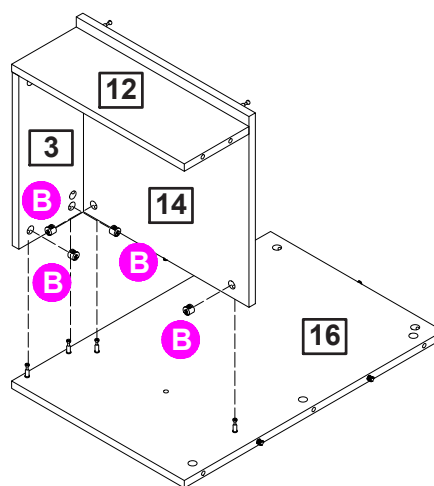
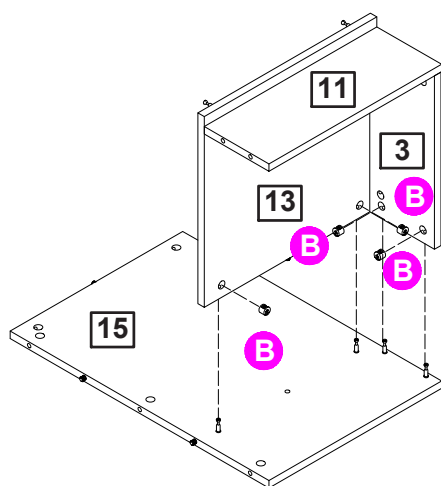
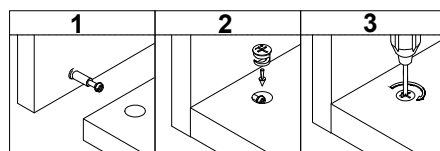

Assembly Instructions / Instructions de montage

Step 27

Étape 27

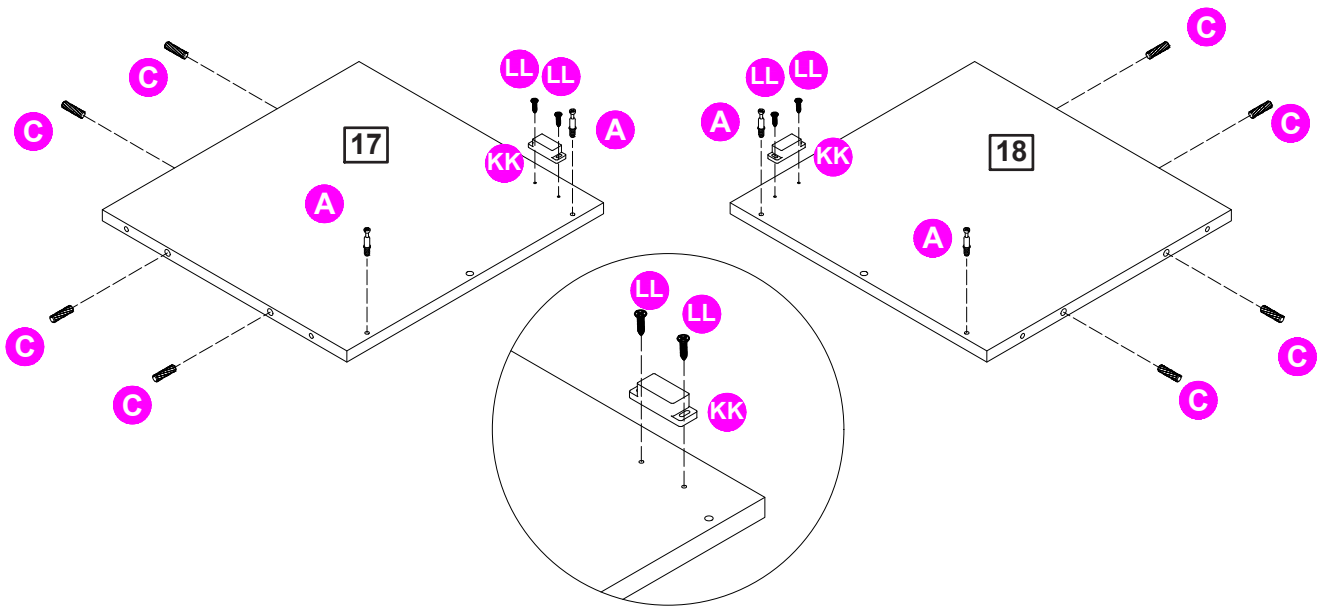
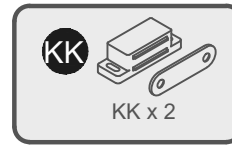
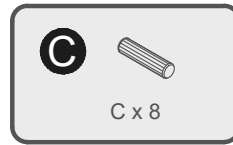
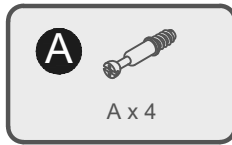

Step 28

Étape 28

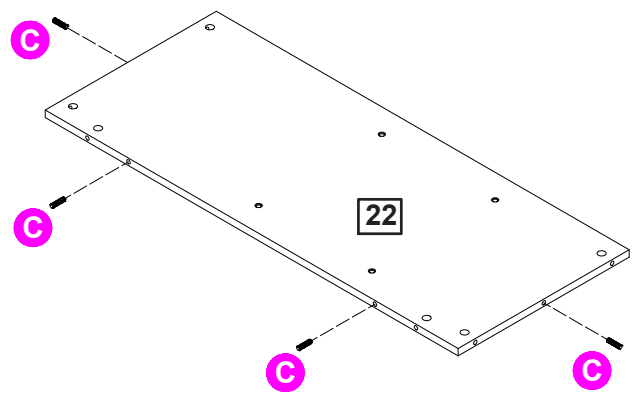
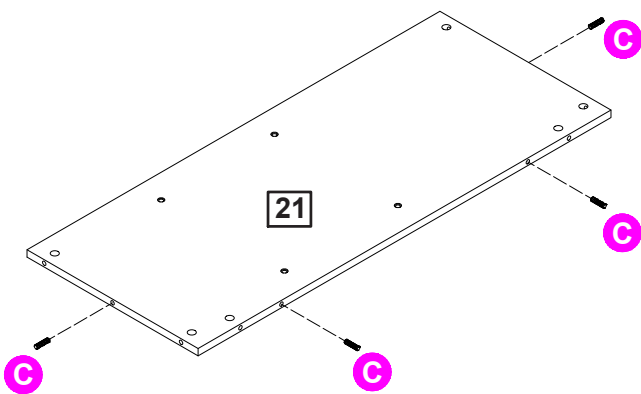

Assembly Instructions / Instructions de montage

Step 29

Étape 29

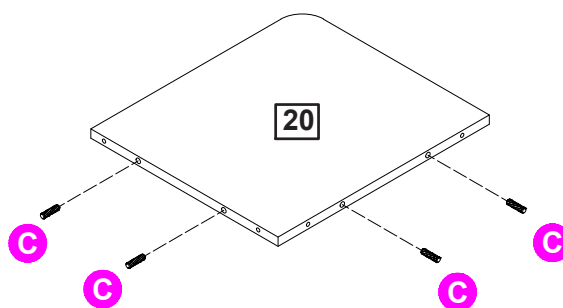
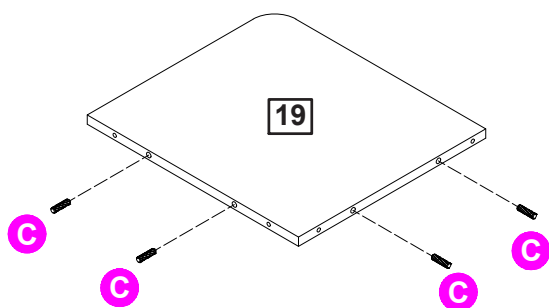

Step 30

Étape 30

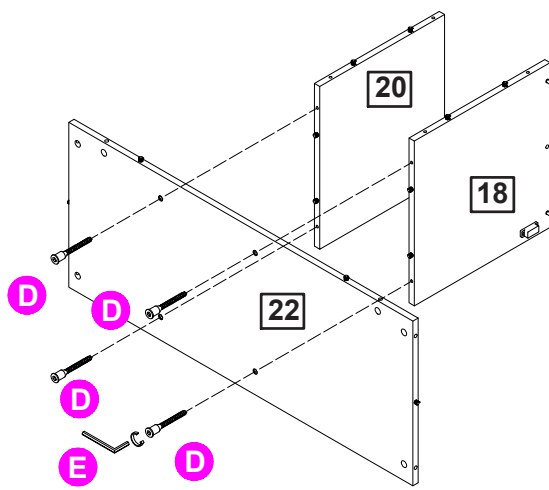
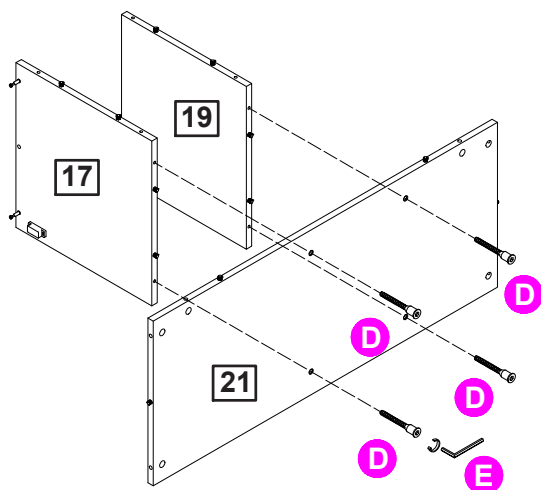

Assembly Instructions / Instructions de montage

Step 31

Étape 31

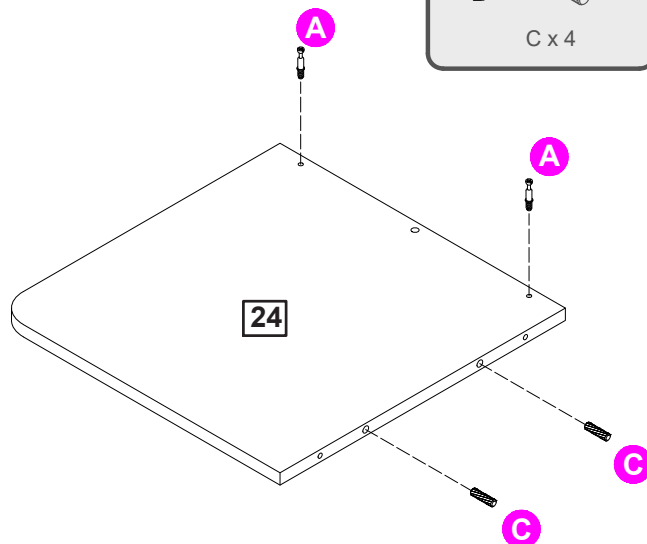
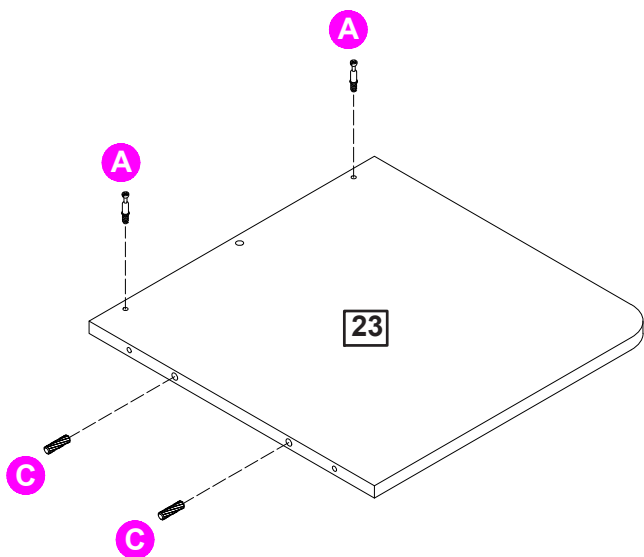

Step 32

Étape 32

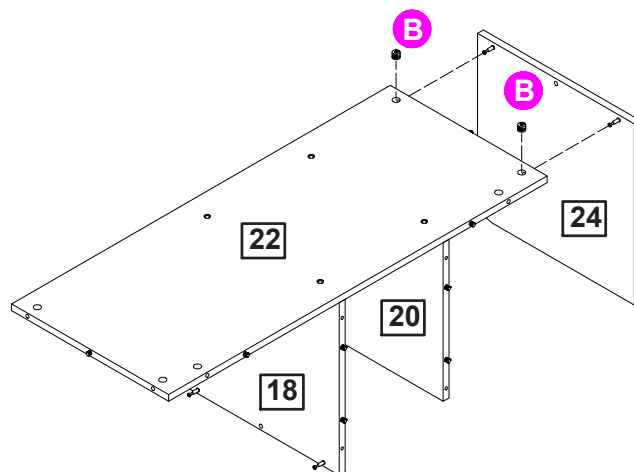
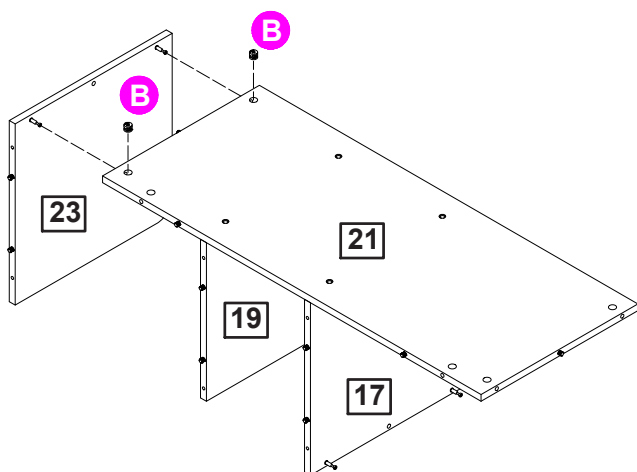
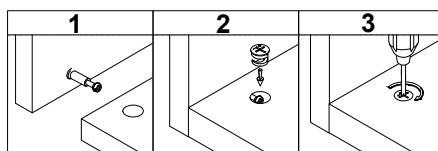

Assembly Instructions / Instructions de montage

Step 33

Étape 33

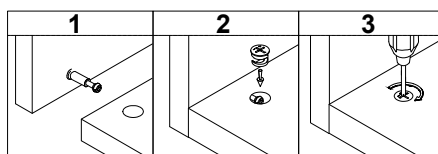

B



B x 8

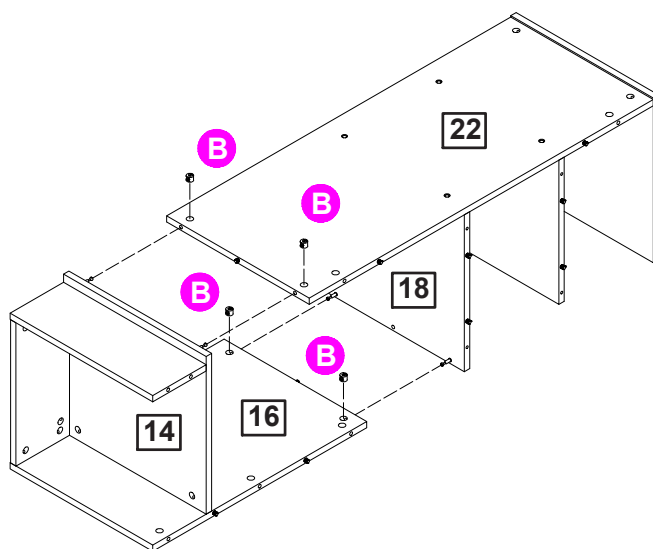
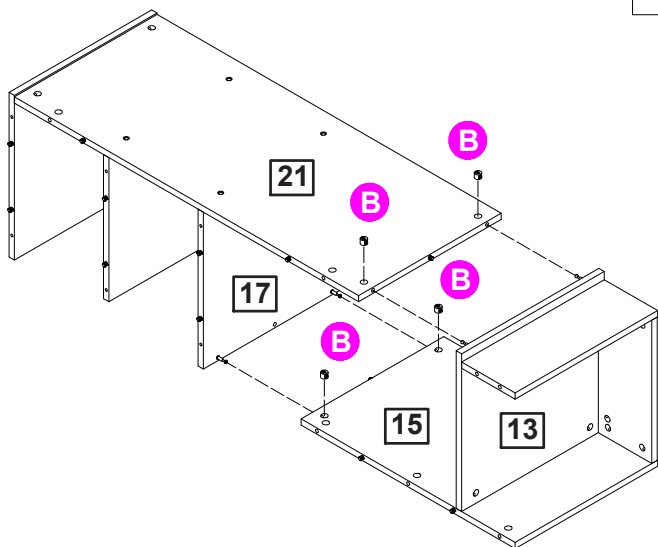

Step 34

Étape 34

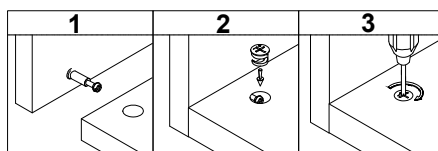

B



B x 5

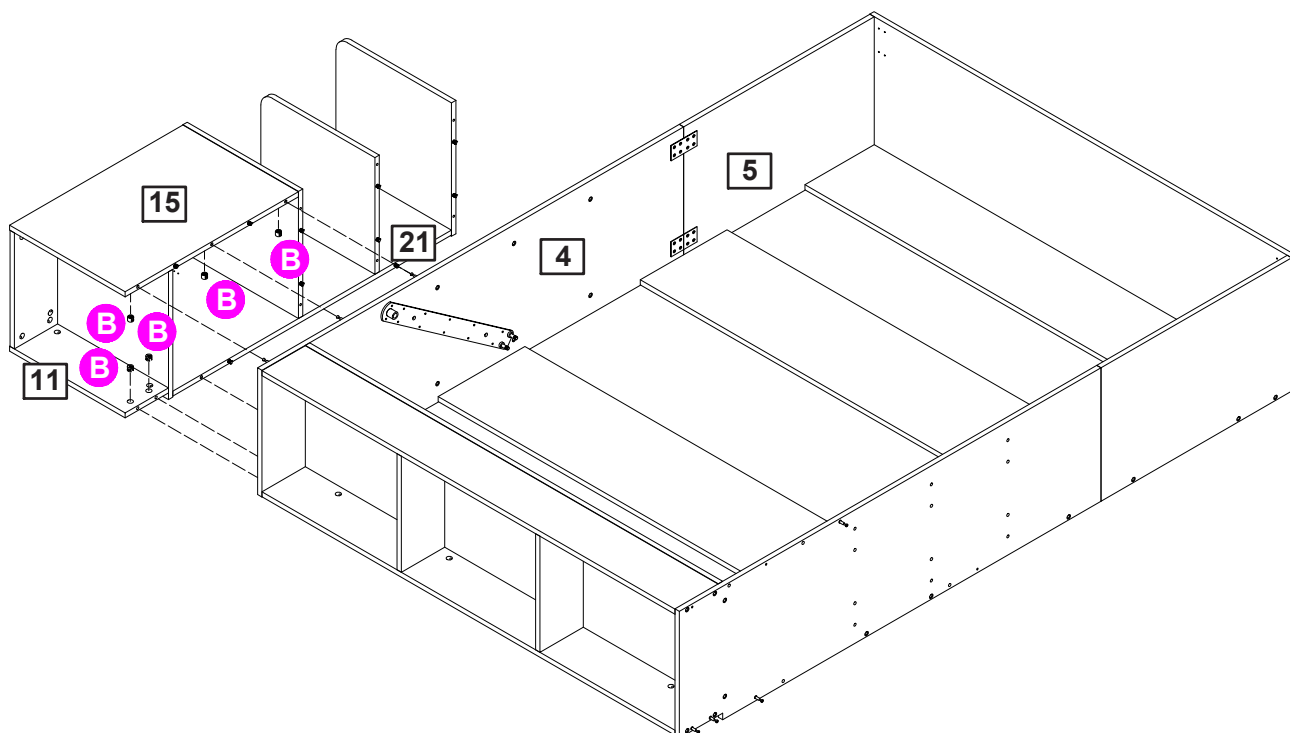

Assembly Instructions / Instructions de montage

Step 35

Étape 35

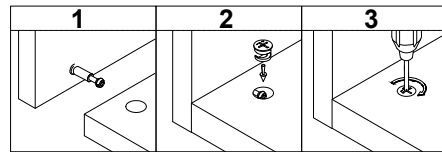

B



B x 5

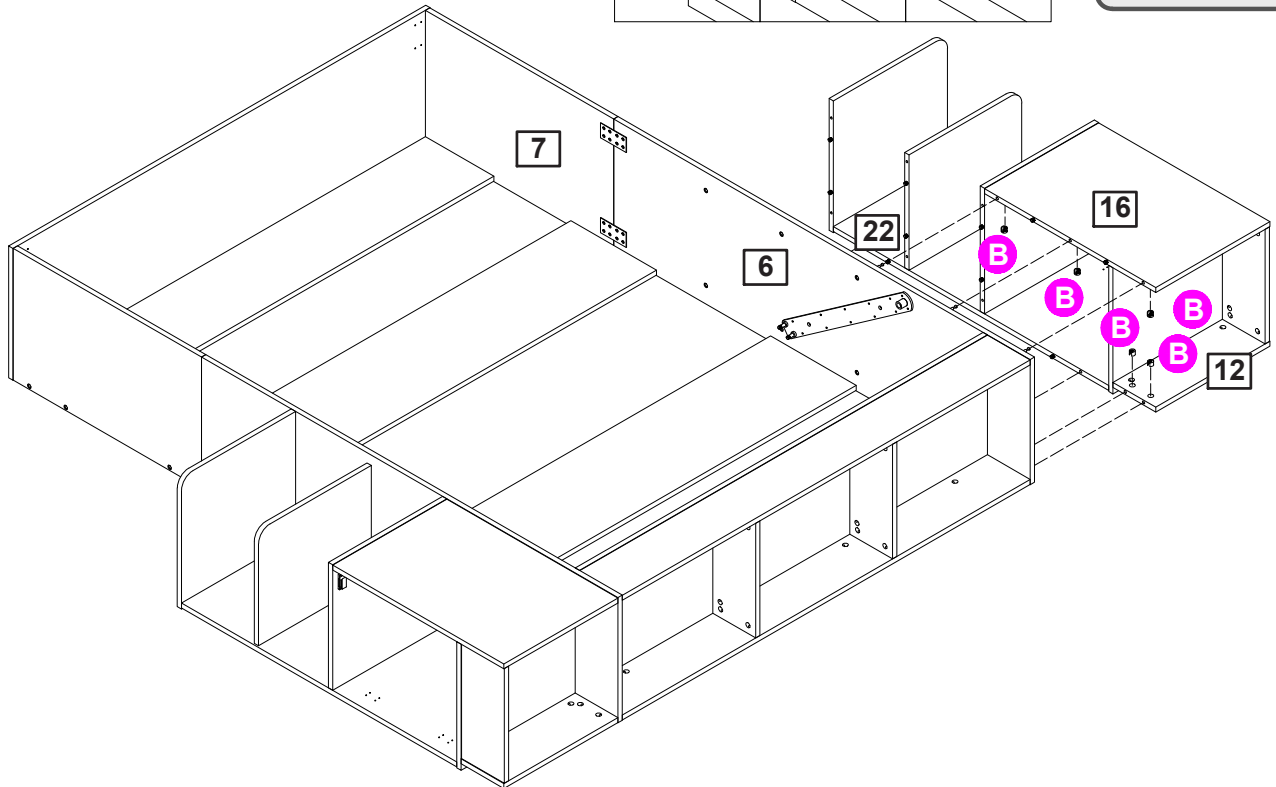

Step 36

Étape 36

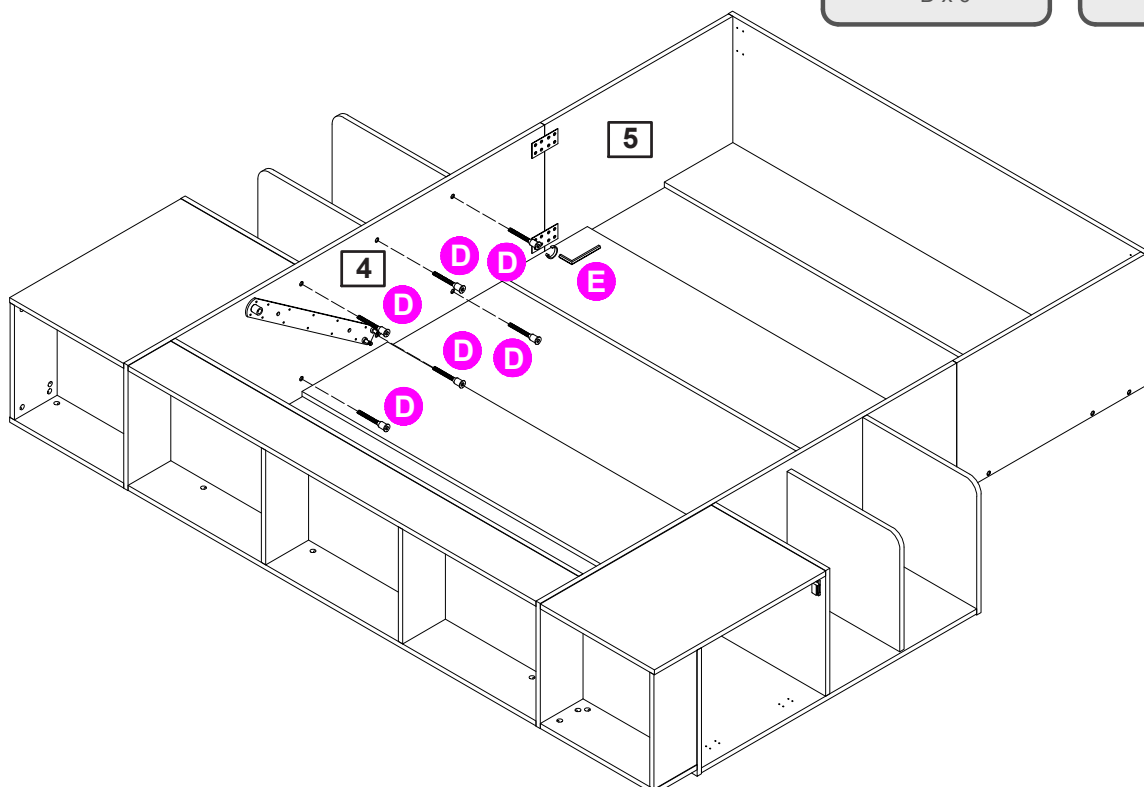

Assembly Instructions / Instructions de montage

Step 37

Étape 37

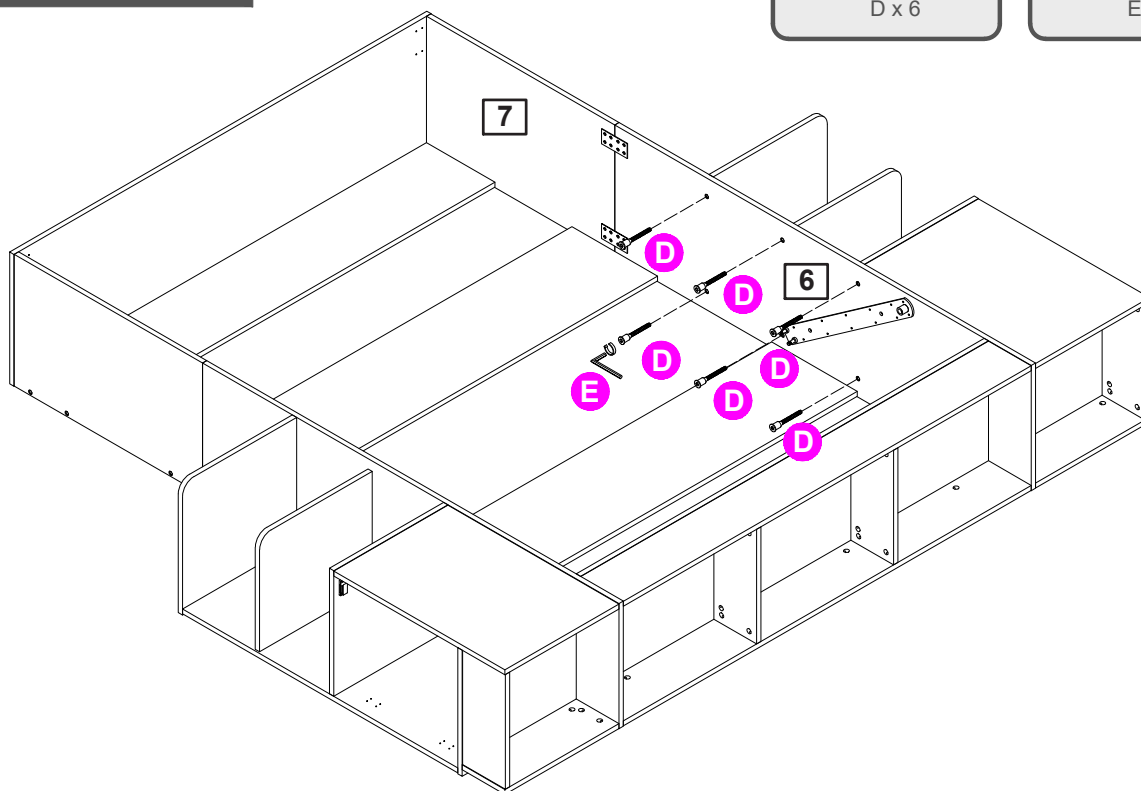
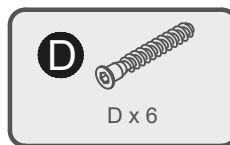

Step 38

Étape 38

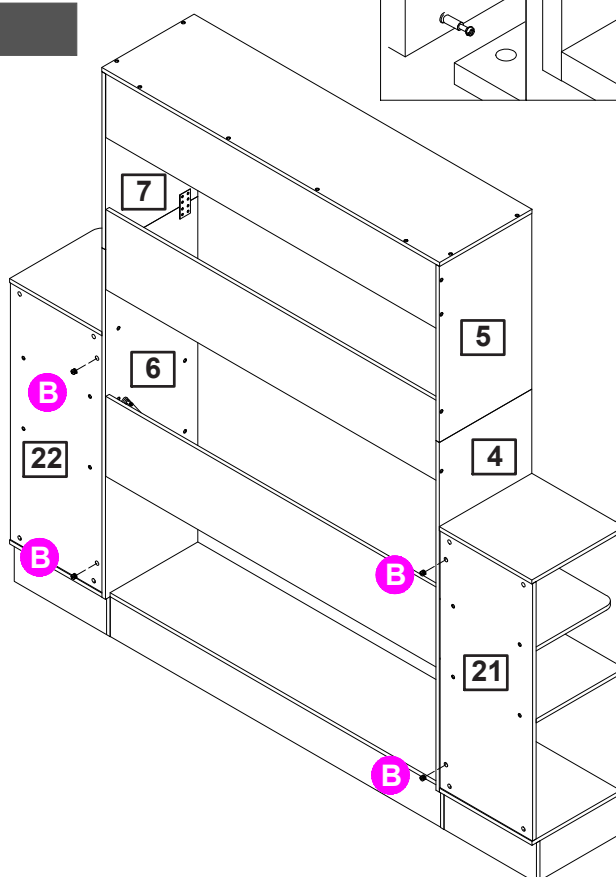
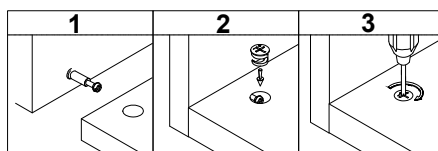

Assembly Instructions / Instructions de montage

Step 39

Étape 39

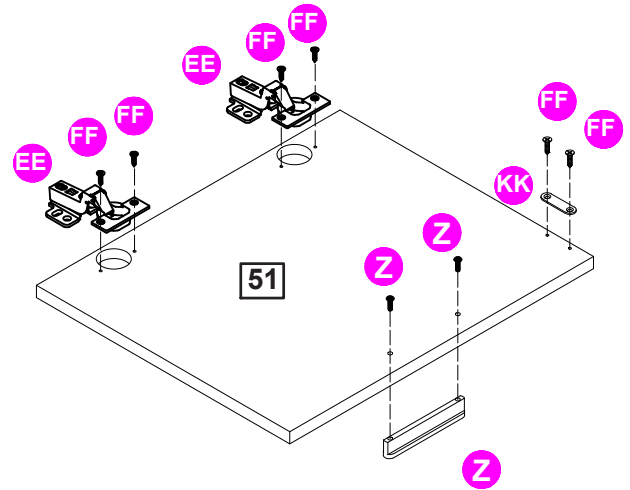
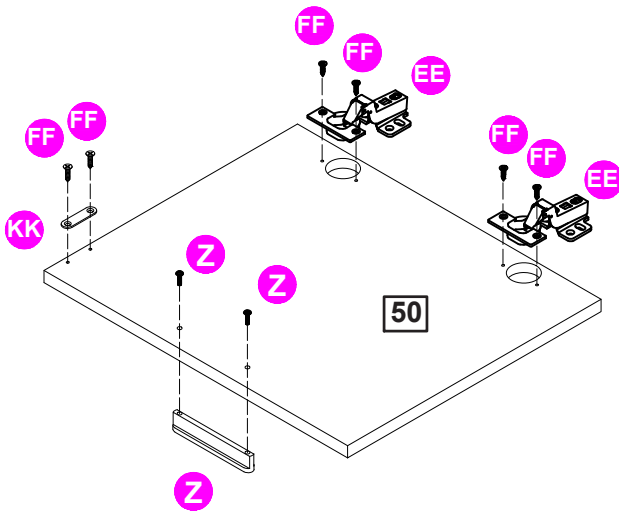
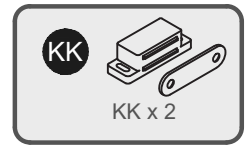
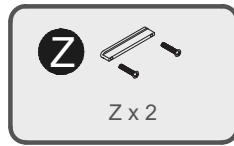

Step 40

Étape 40

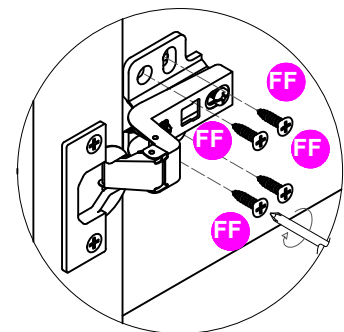
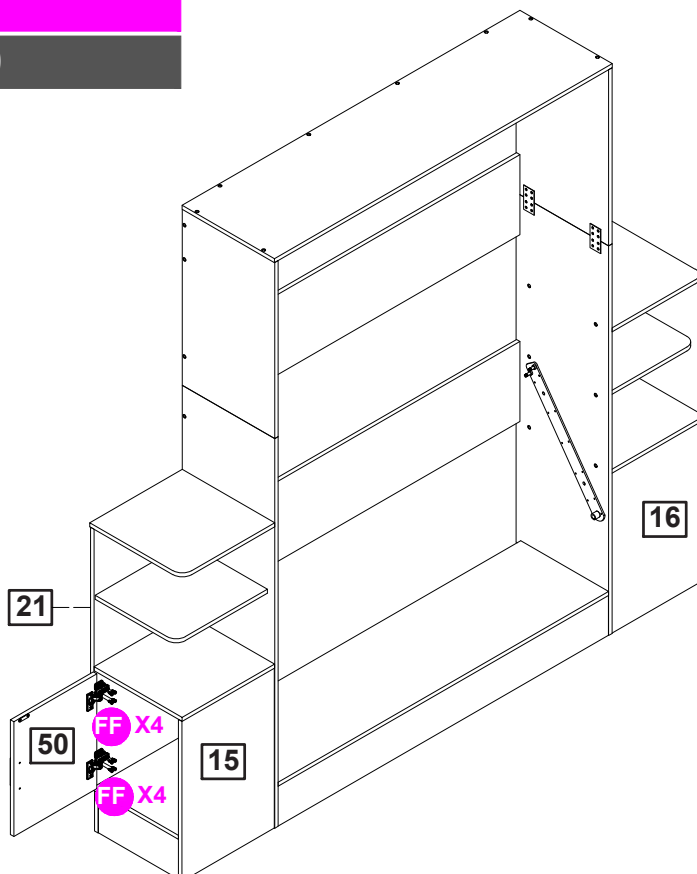
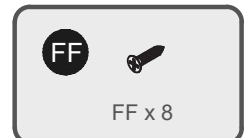

Assembly Instructions / Instructions de montage

Step 39

Étape 39

FF



FF x 8

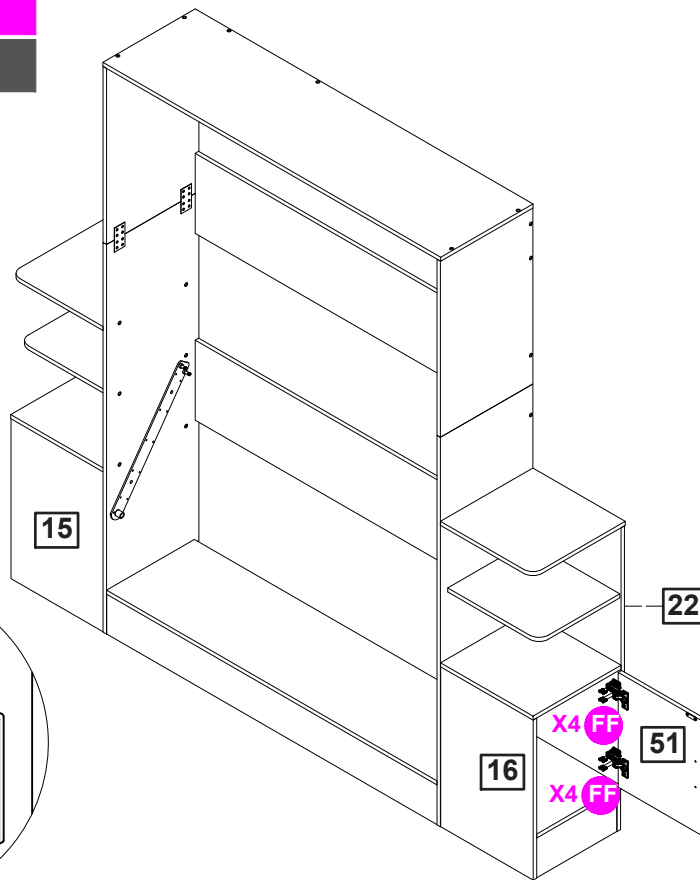
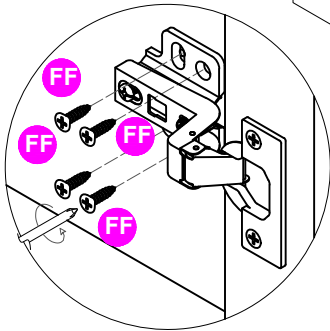

Step 40

Étape 40

T



T x 4

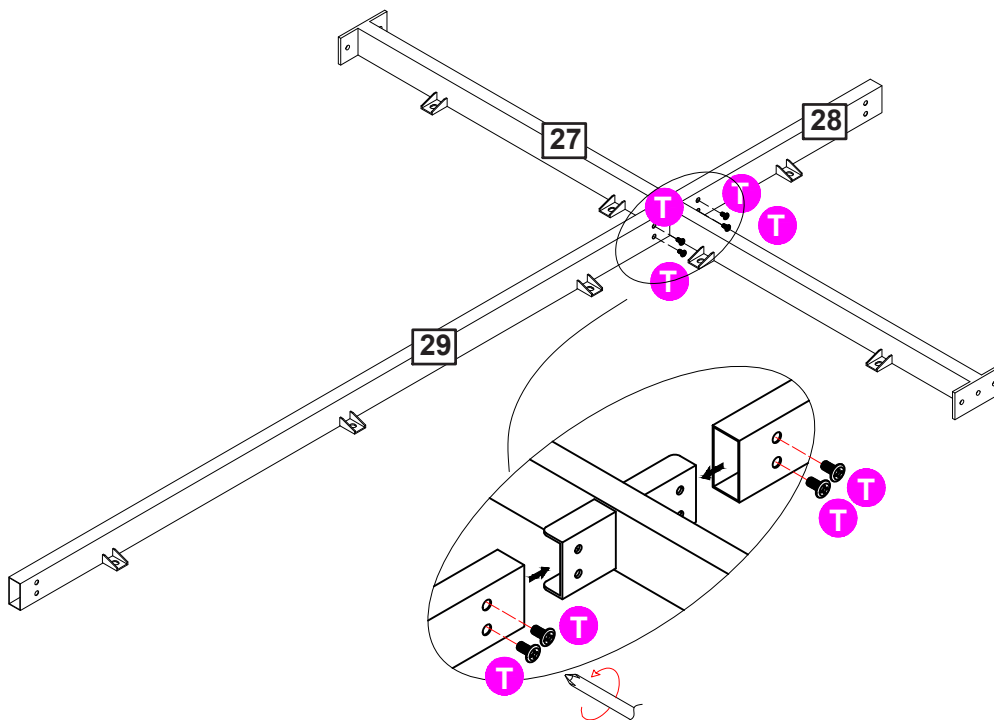

Assembly Instructions / Instructions de montage

Step 41

Étape 41

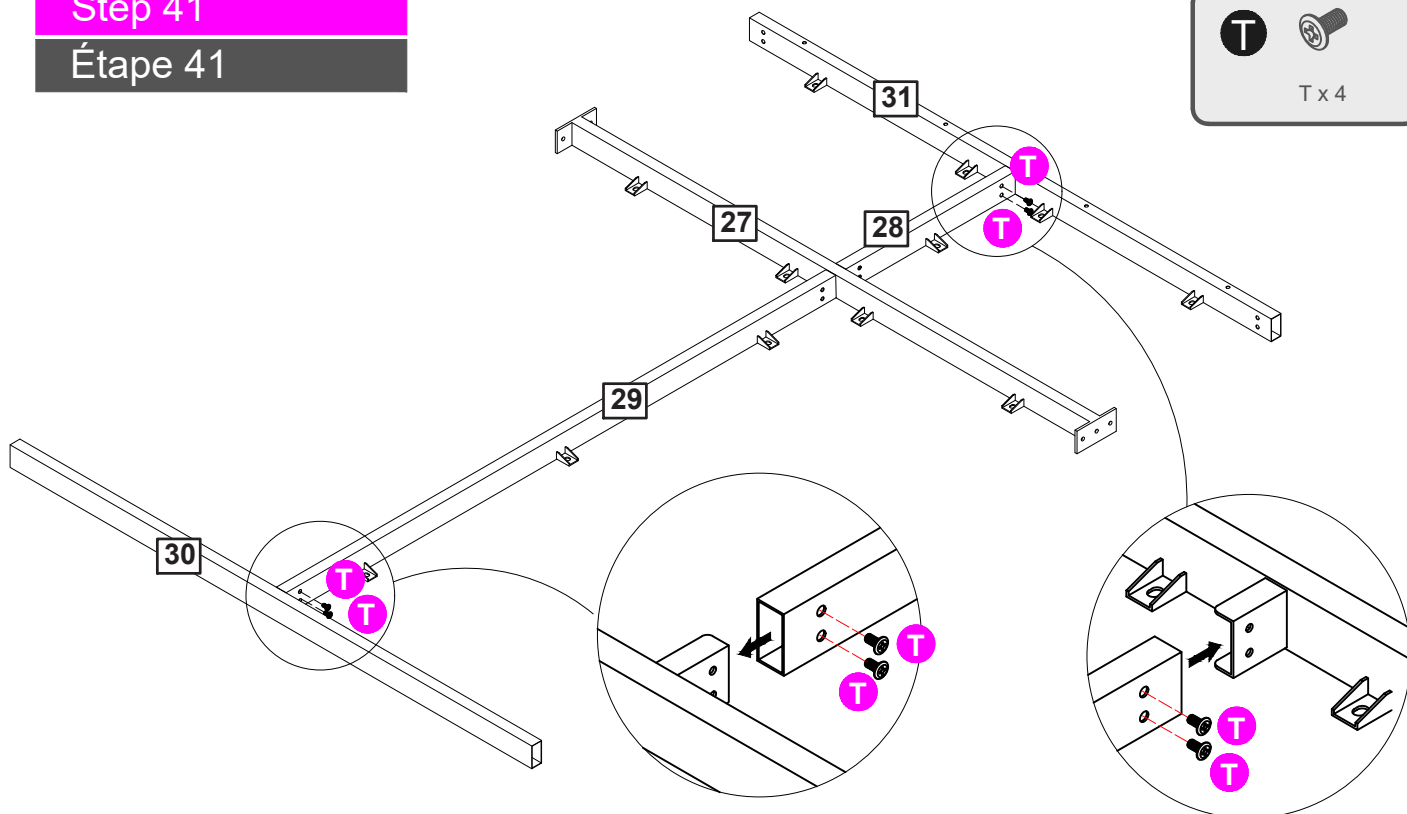

Step 42

Étape 42

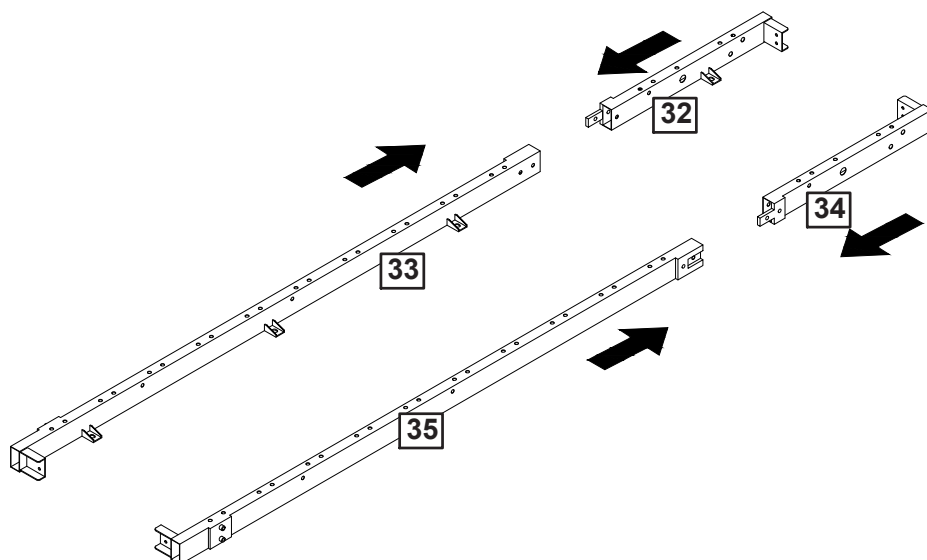

Assembly Instructions / Instructions de montage

Step 43

Étape 43

make sure the tube with mattress stopper holes is in the head position and the tube without any holes are in the foot part. after you assemble the frame, take the measurement to ensure $X=Y$

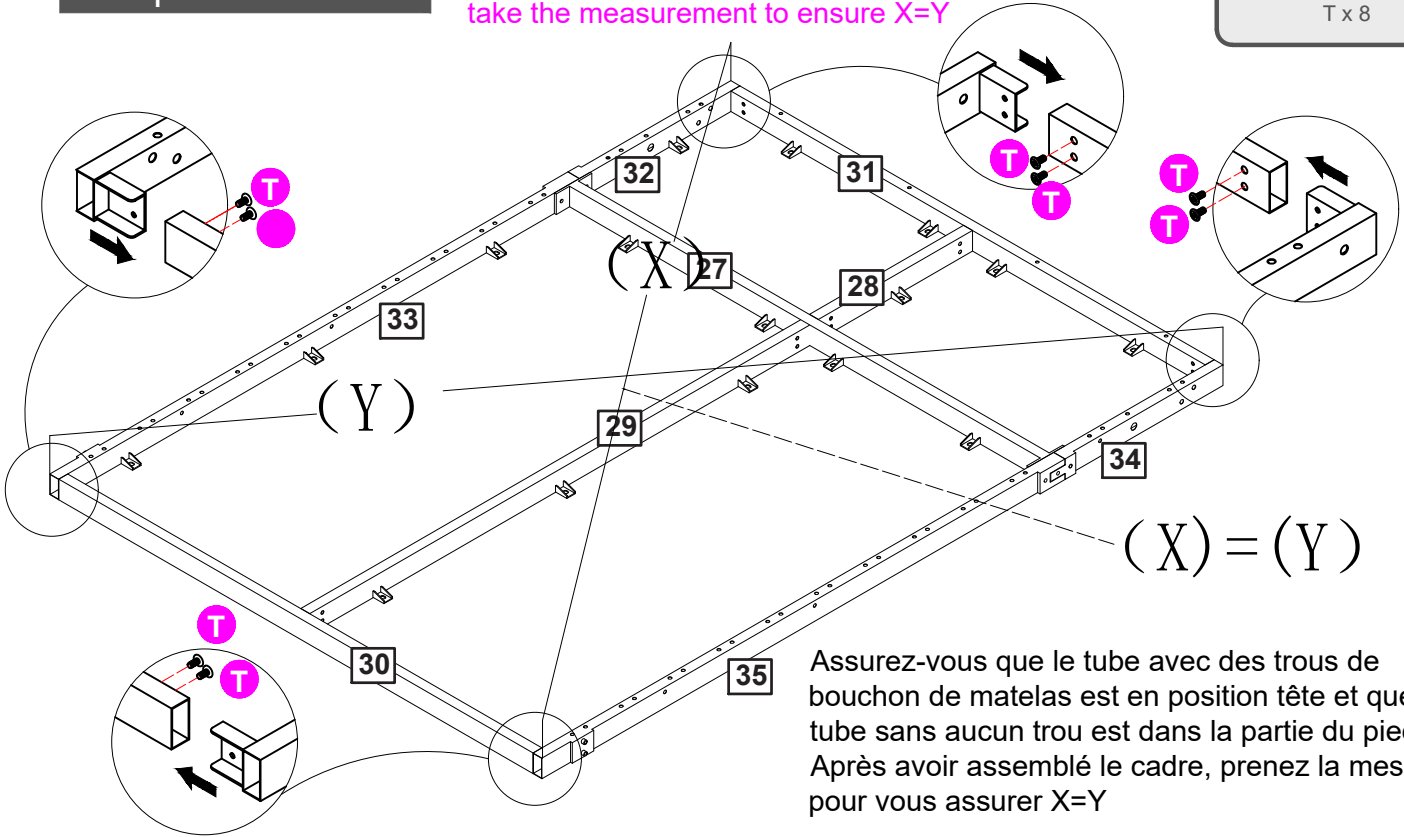

Step 44

Étape 44

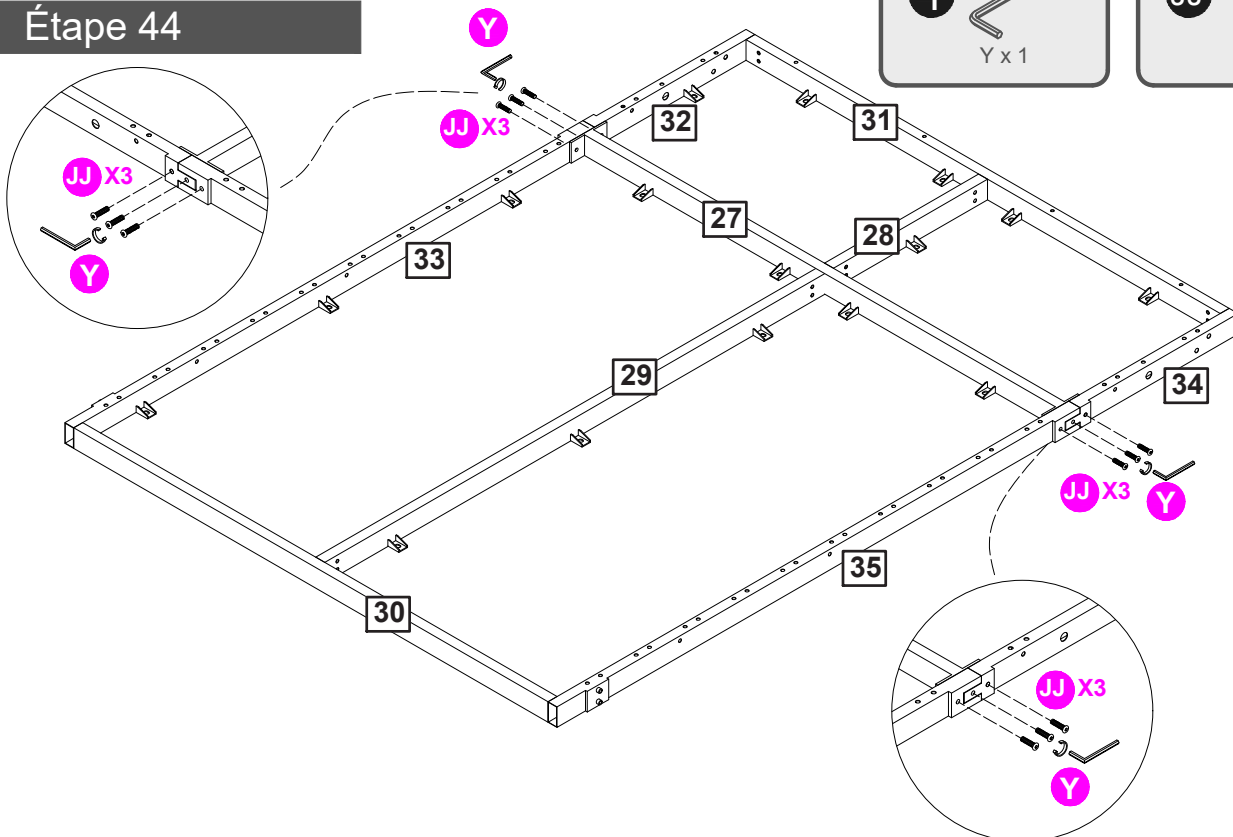

Assembly Instructions / Instructions de montage

Step 45

Étape 45

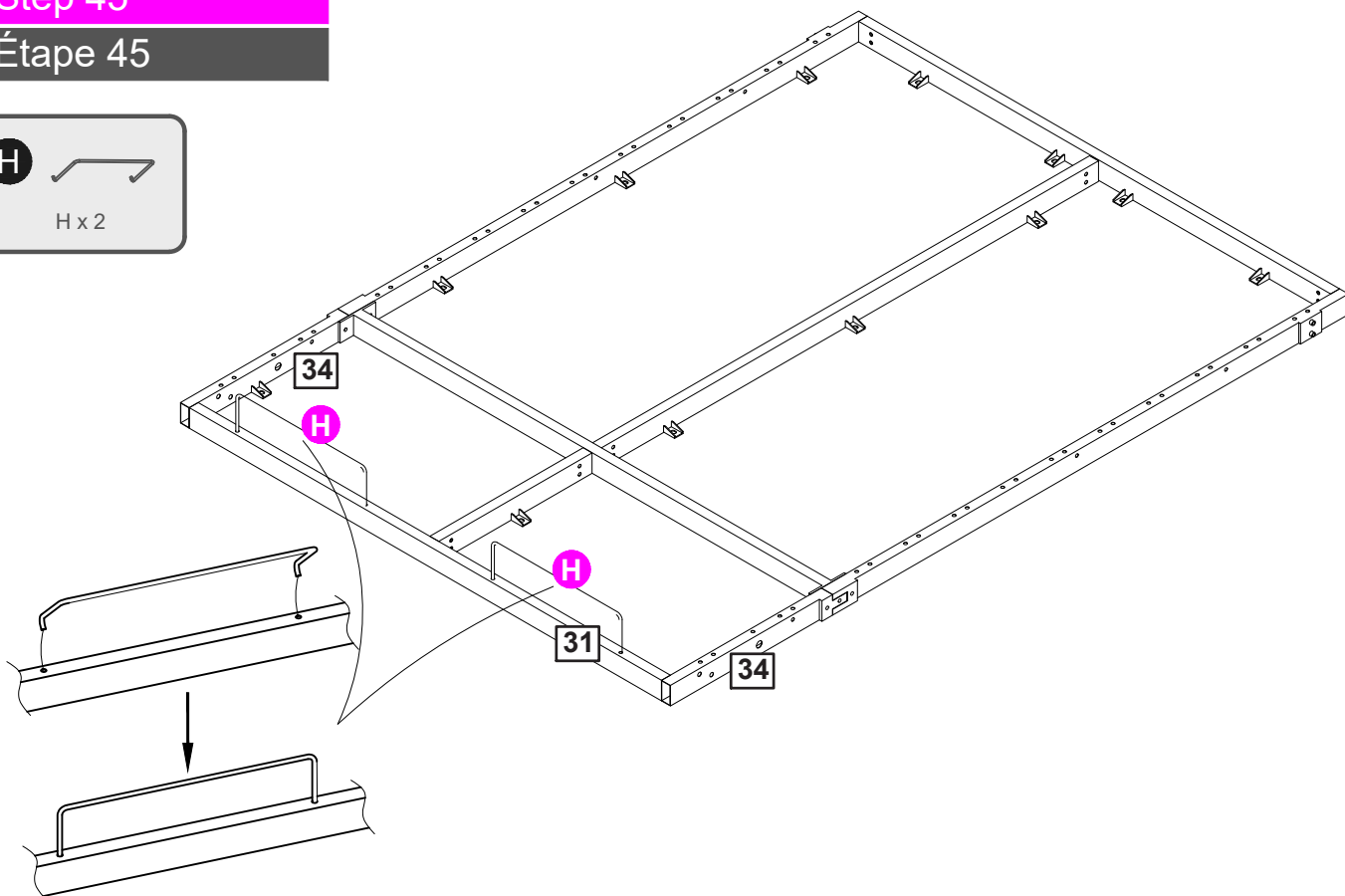
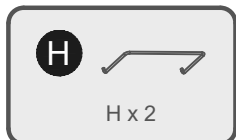

Step 46

Étape 46

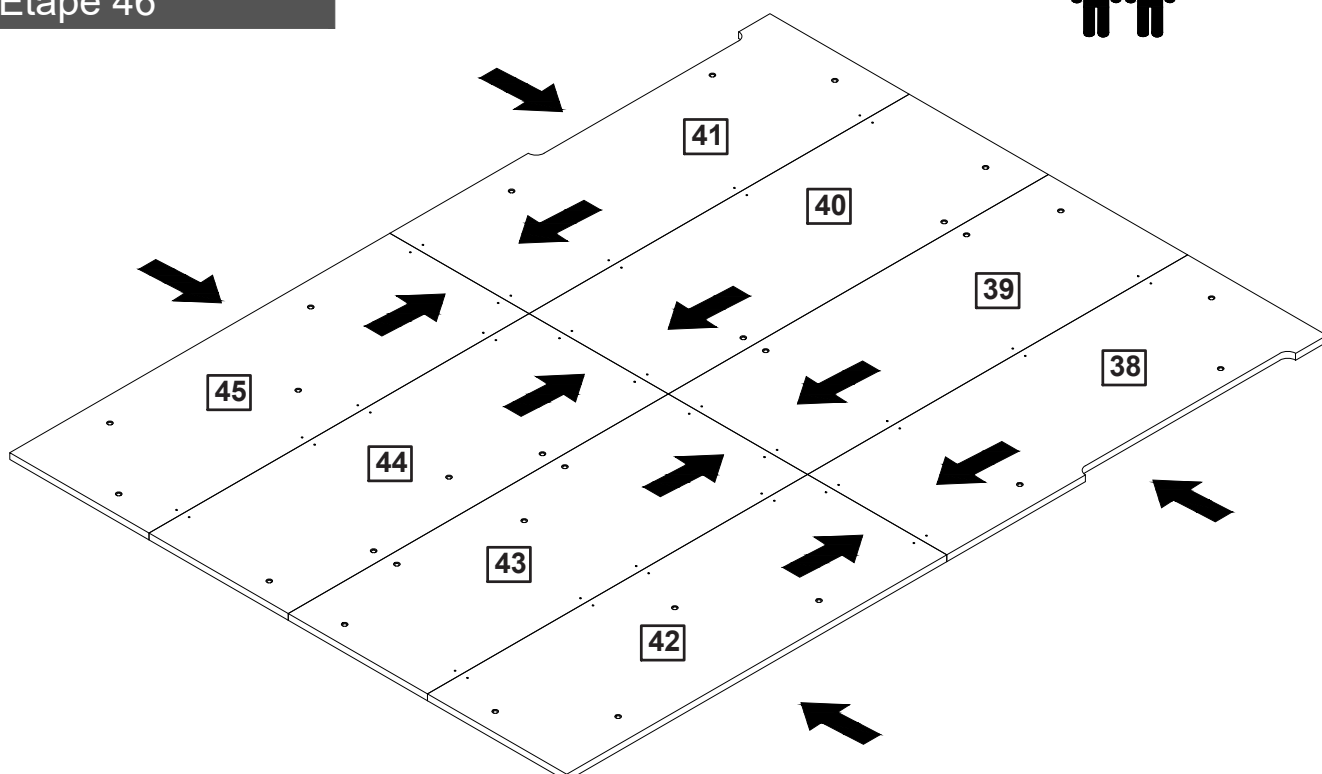

Assembly Instructions / Instructions de montage

Step 47

Étape 47

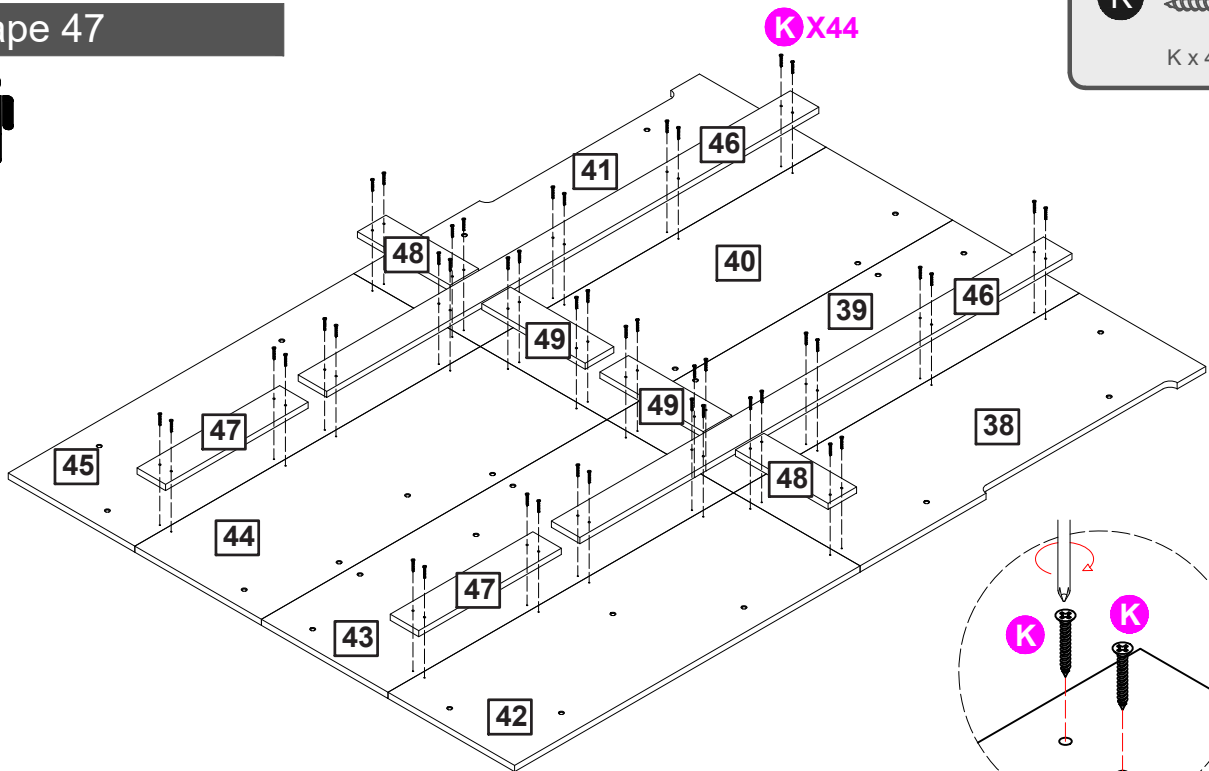

K x 44

Step 48

Étape 48

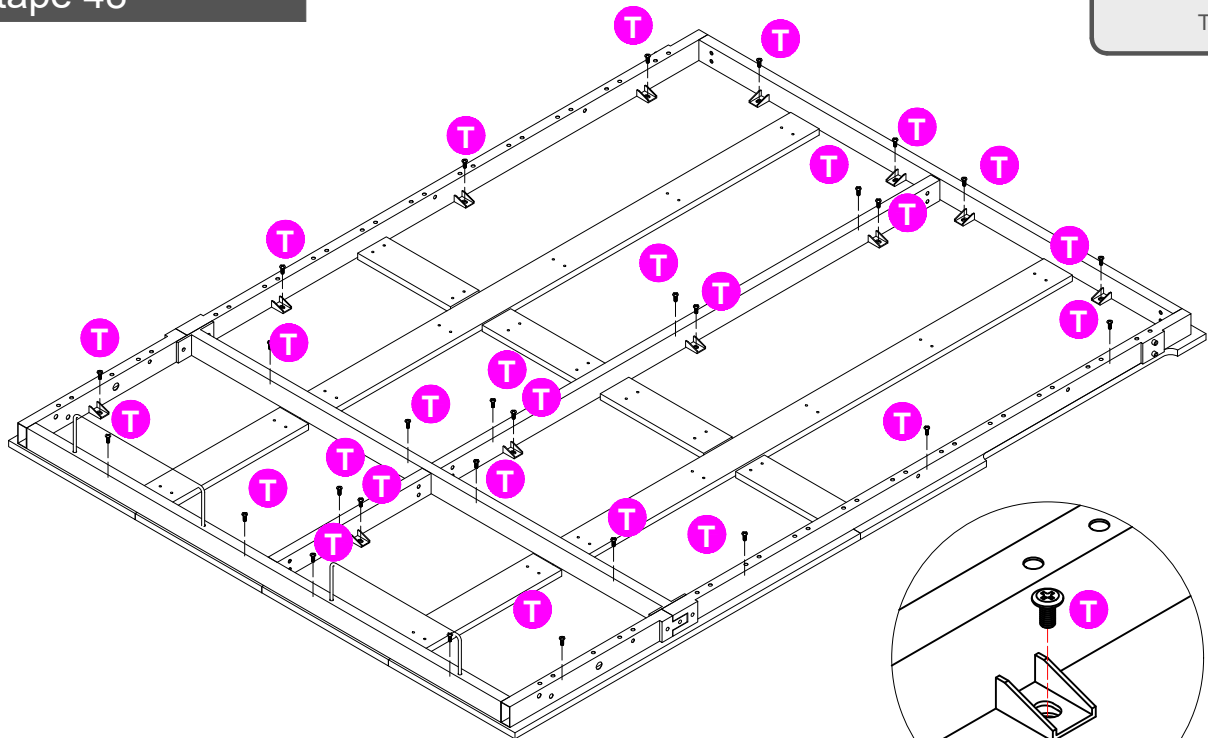

T x 28

Assembly Instructions / Instructions de montage

Step 49

Étape 49

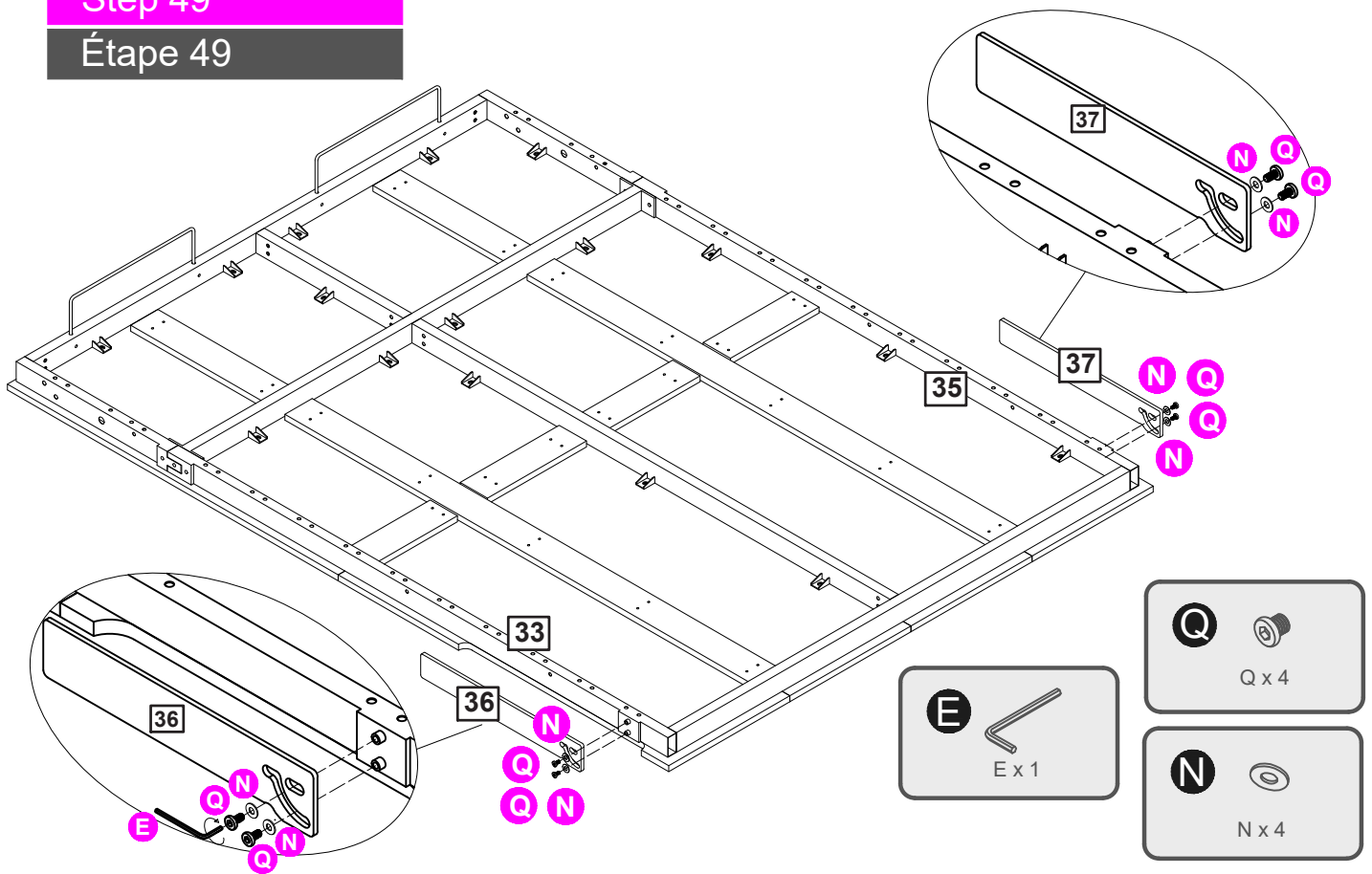

Step 50

Étape 50

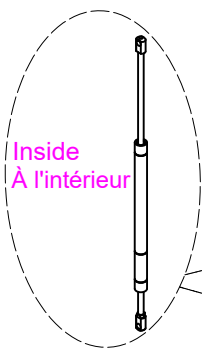
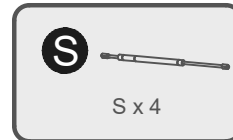

The inside hydraulic,
the thin metal rod
pointing upward
L'intérieur hydraulique,
La fine tige métallique
Pointant vers le haut

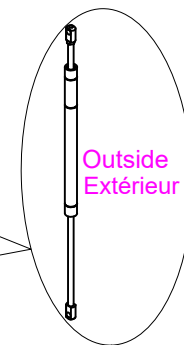

The outside hydraulic,
the thin metal rod
pointing downwards
L'hydraulique extérieure,
La fine tige métallique
Pointant vers le bas

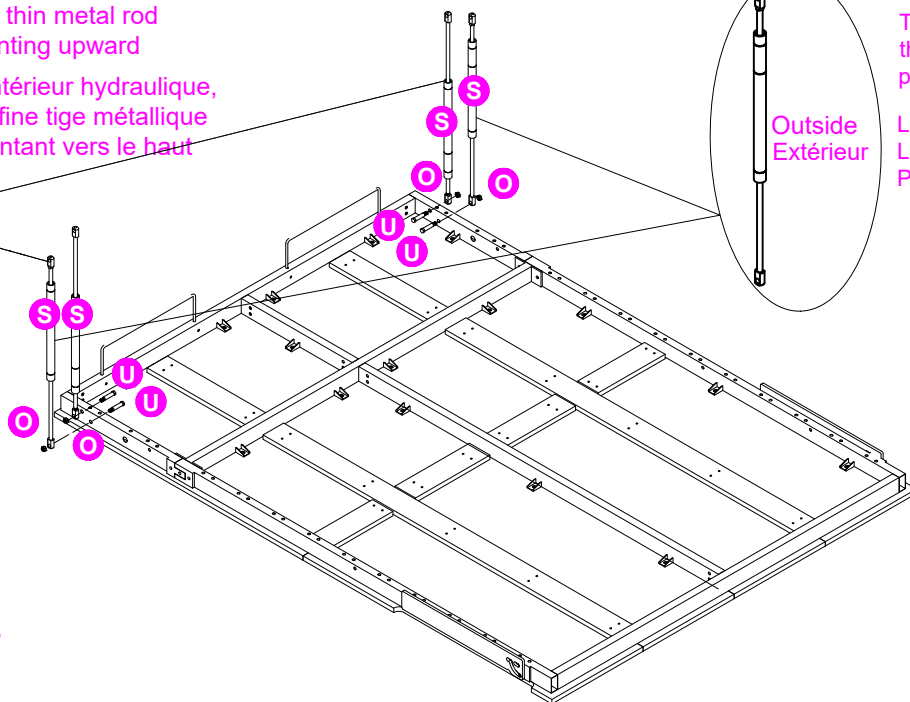
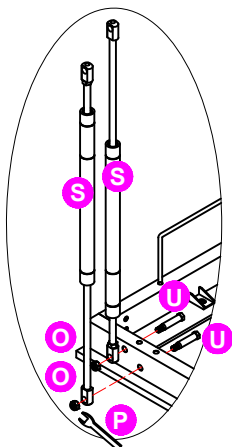

Assembly Instructions / Instructions de montage

Step 51

Étape 51

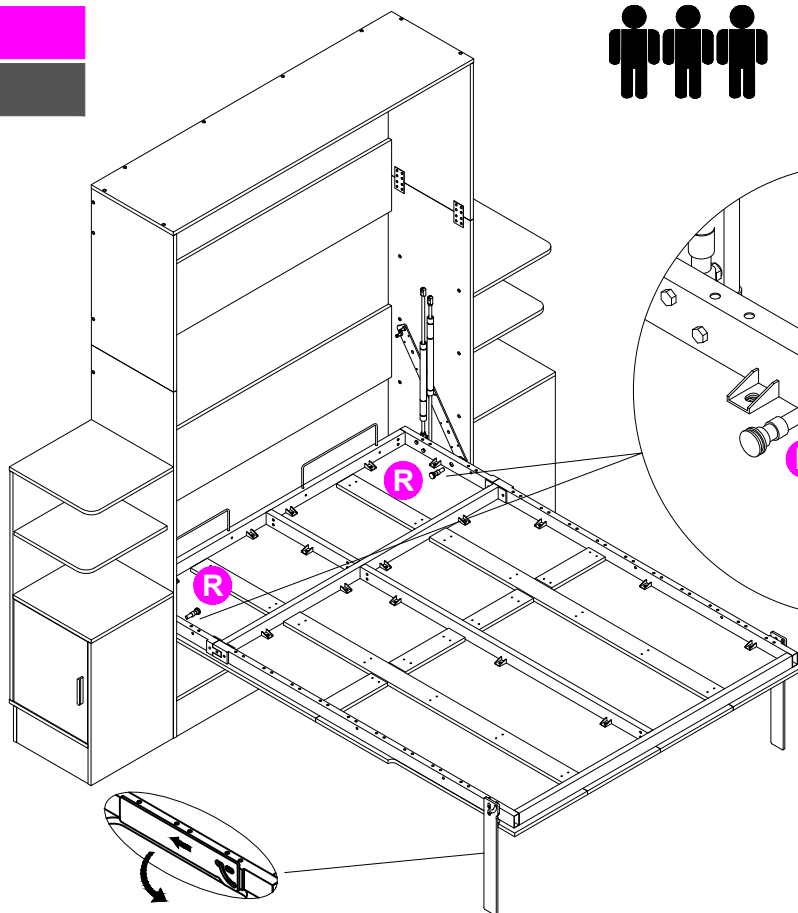

Step 52

Étape 52

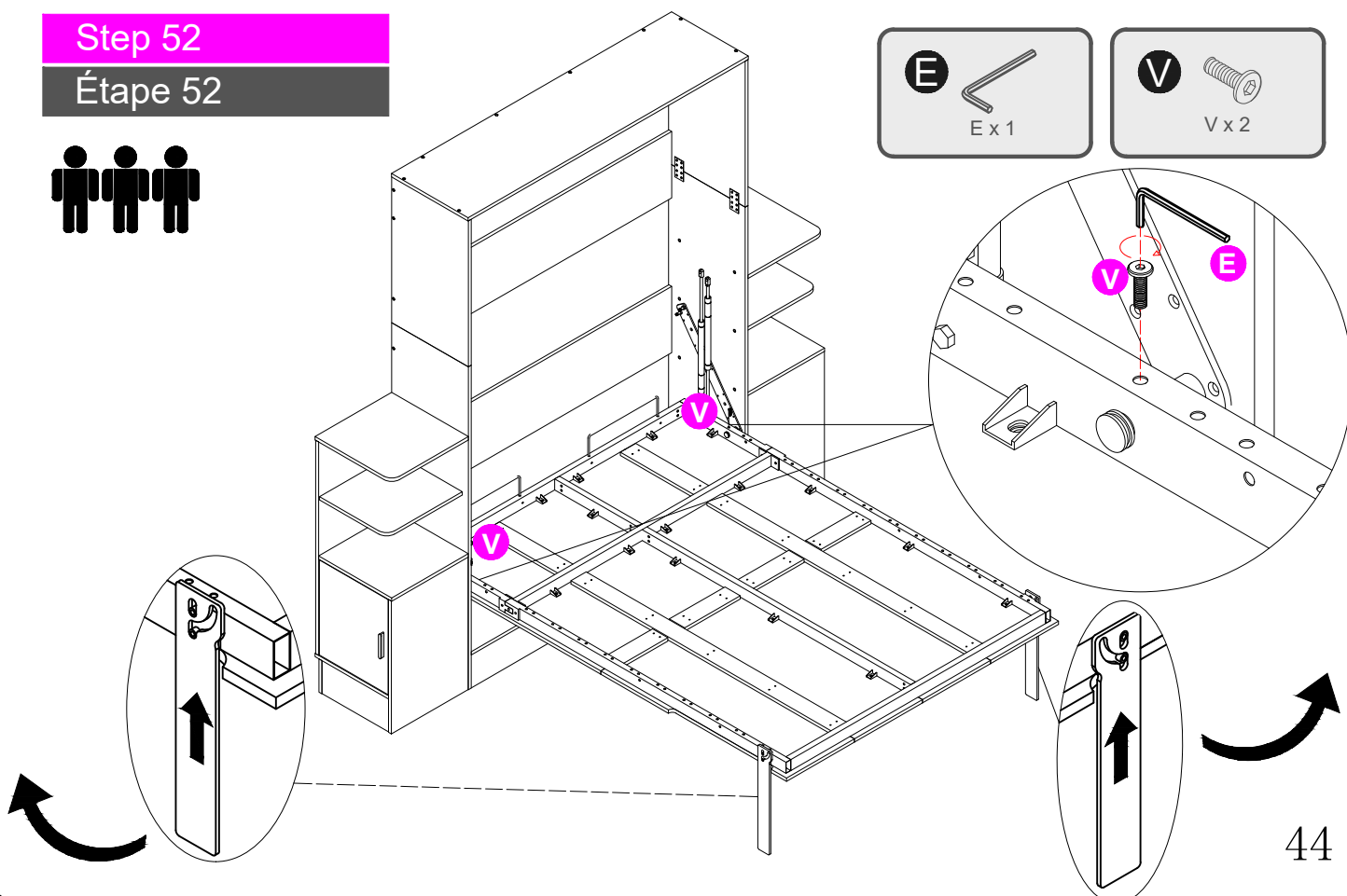
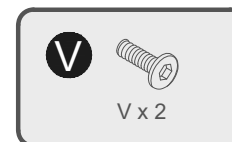

Assembly Instructions / Instructions de montage

Step 53

Étape 53

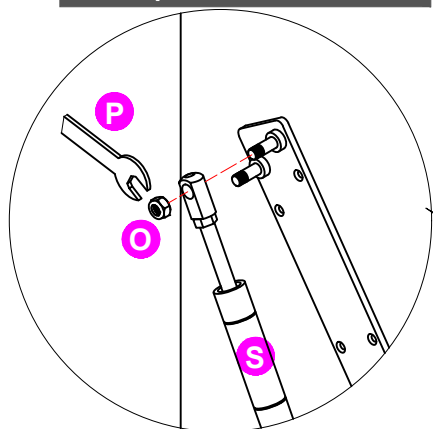

INSERT CYLINDER ON ITS STEM

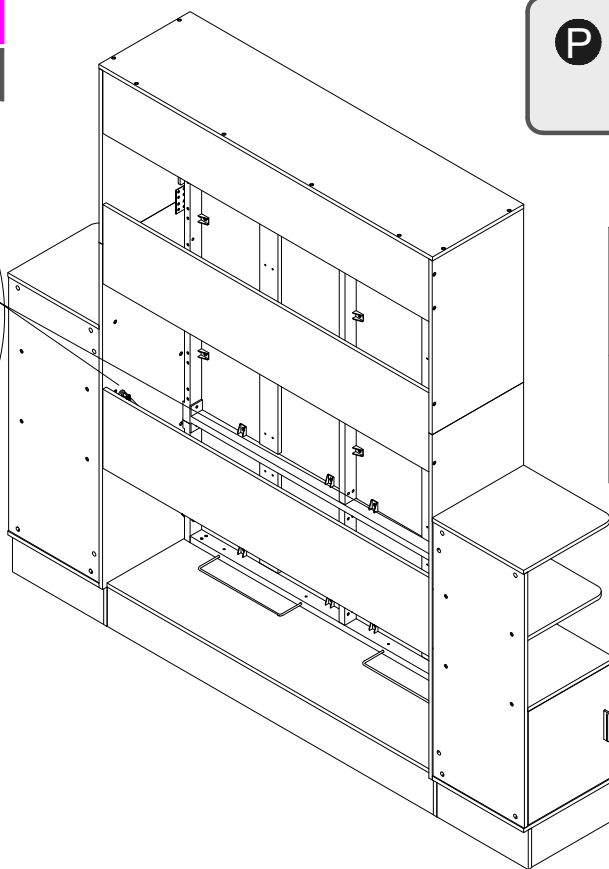
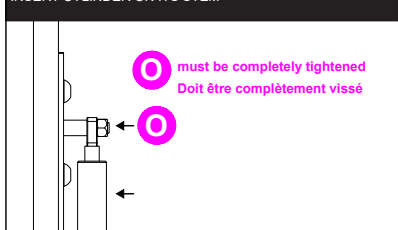

1. Push the door to the bottom
2. Push the door forward a little, let the Cylinder rod cover the screw head

1. Poussez la porte vers le bas
2. Poussez la porte un peu en avant, Laissez la tige du cylindre couvrir Tête de vis

Step 54

Étape 54

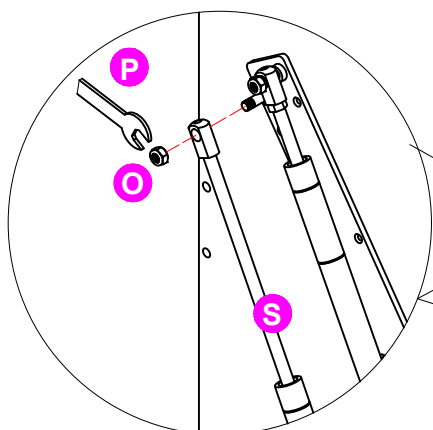

INSERT CYLINDER ON ITS STEM

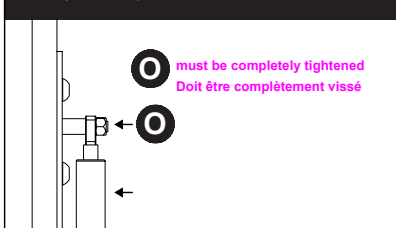

Adjust the distance of the door, let the Cylinder rod cover the screw head
Ajustez la distance de la porte, laissez Tête de vis de culasse de tige de cylindre

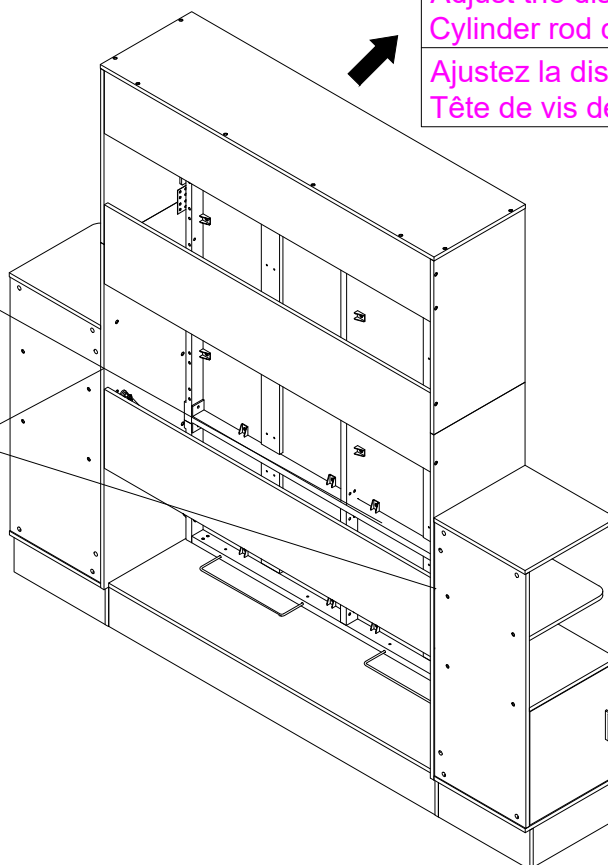

Assembly Instructions / Instructions de montage

Step 55

Étape 55

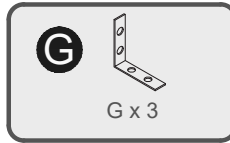

WALL
Les murs

(1)

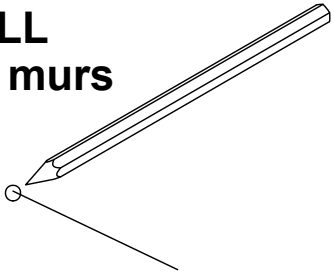

(2)

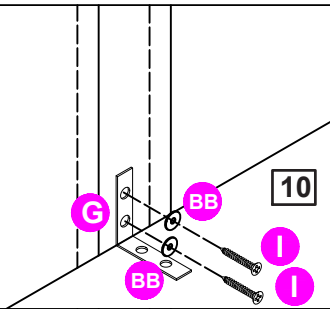

(3)

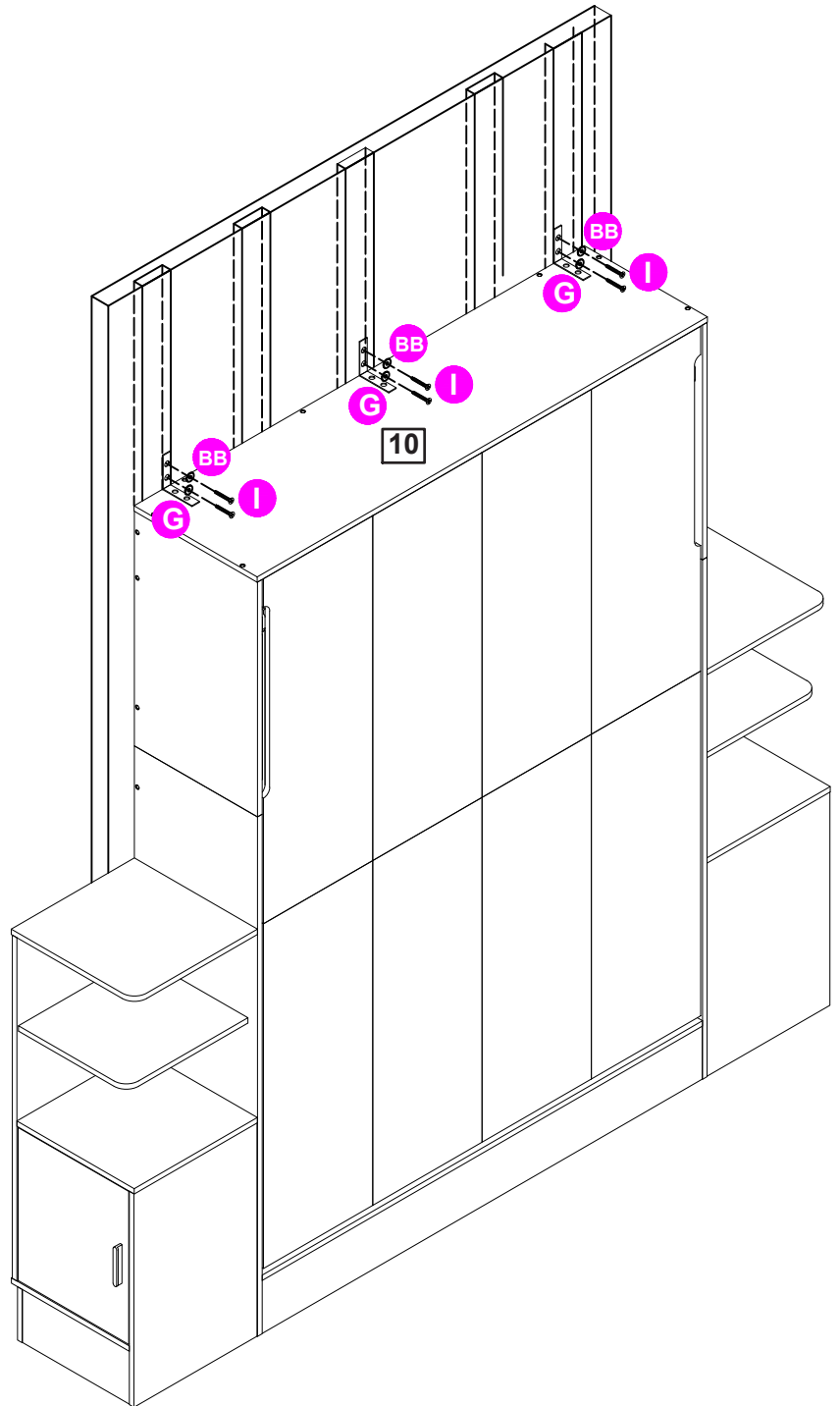
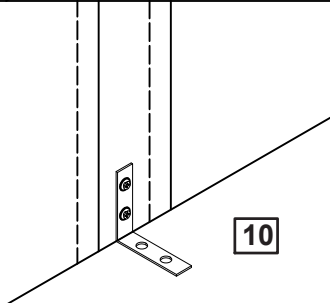

Assembly Instructions / Instructions de montage

Step 56

Étape 56

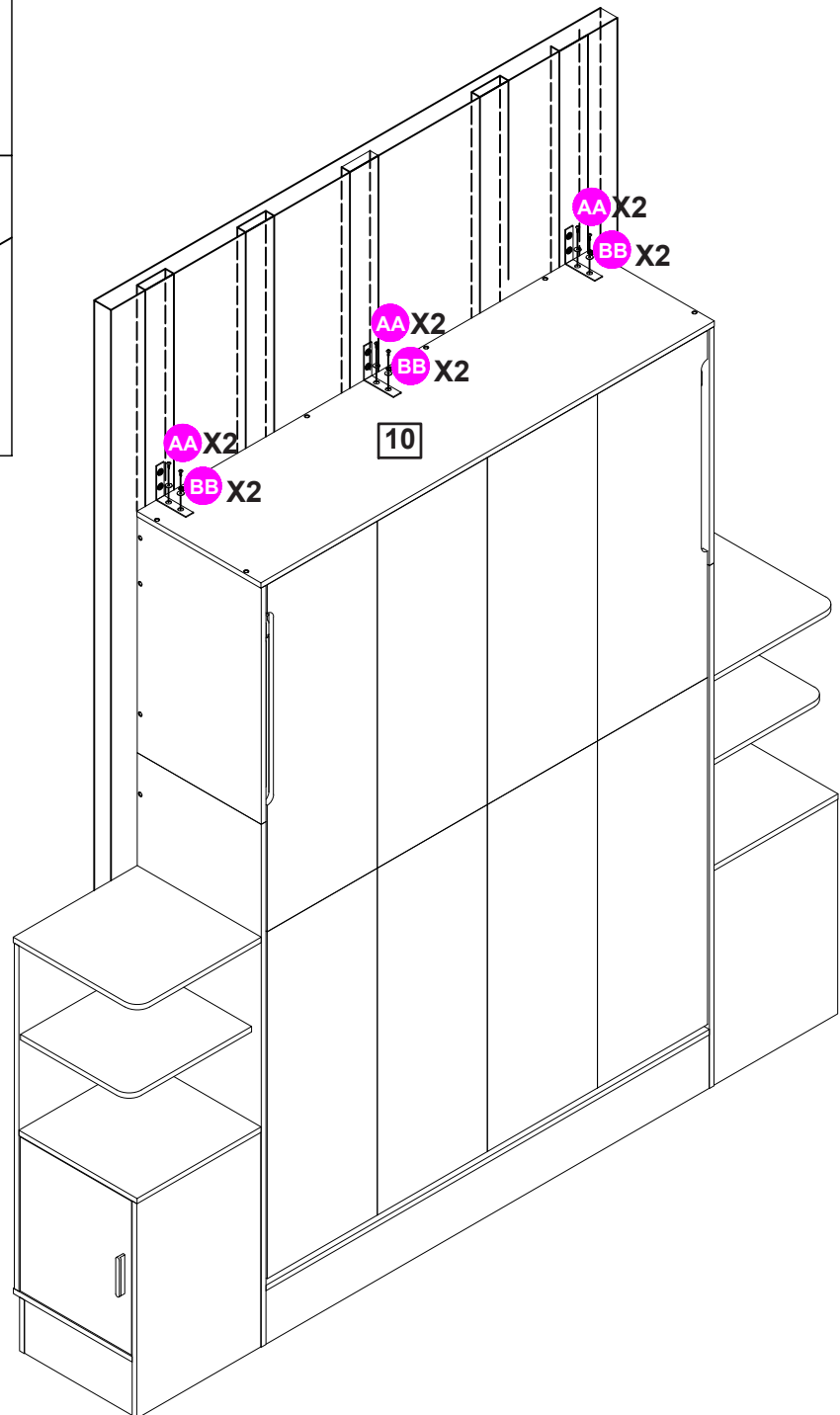
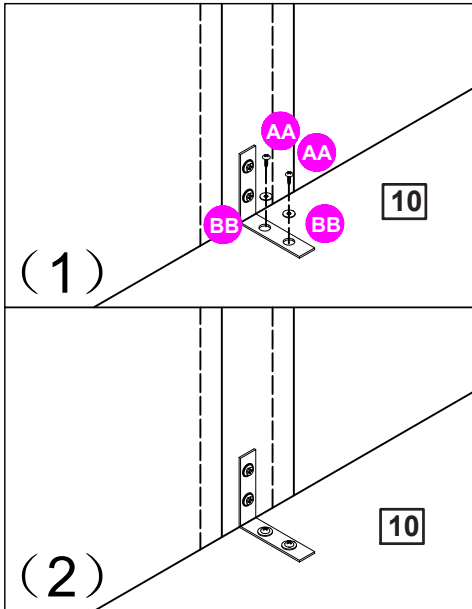
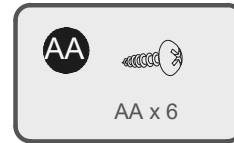

Assembly Instructions / Instructions de montage

Step 57

Étape 57

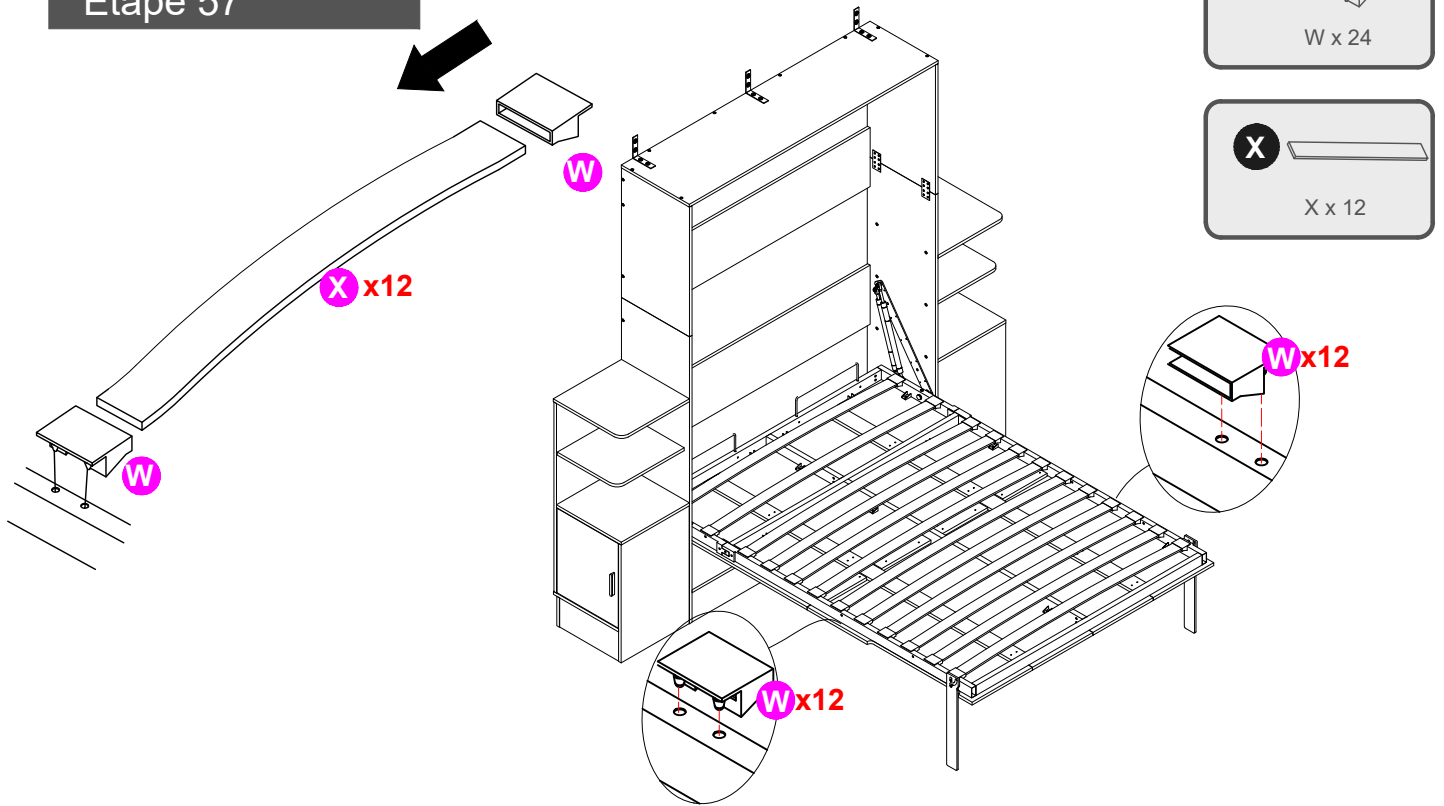

Step 58

Étape 58

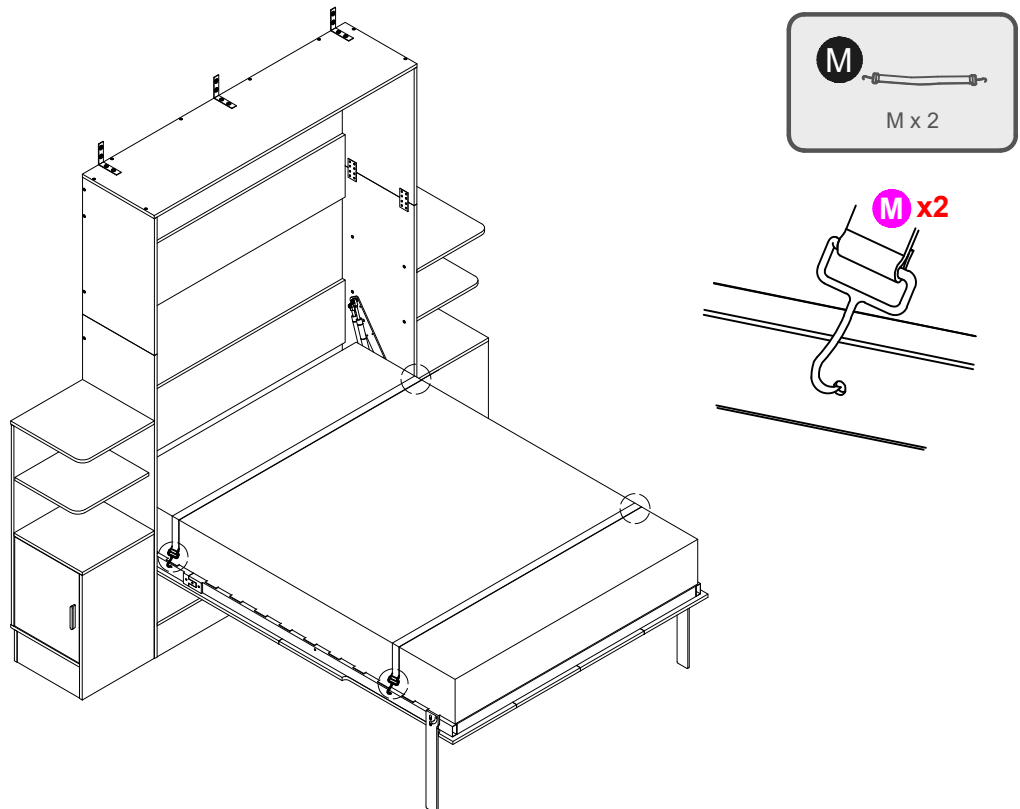

Please open the leg before completely lower the bed.
Veuillez ouvrir la jambe avant d'abaisser complètement le lit.

Assembly Instructions / Instructions de montage

Step 59

Étape 59

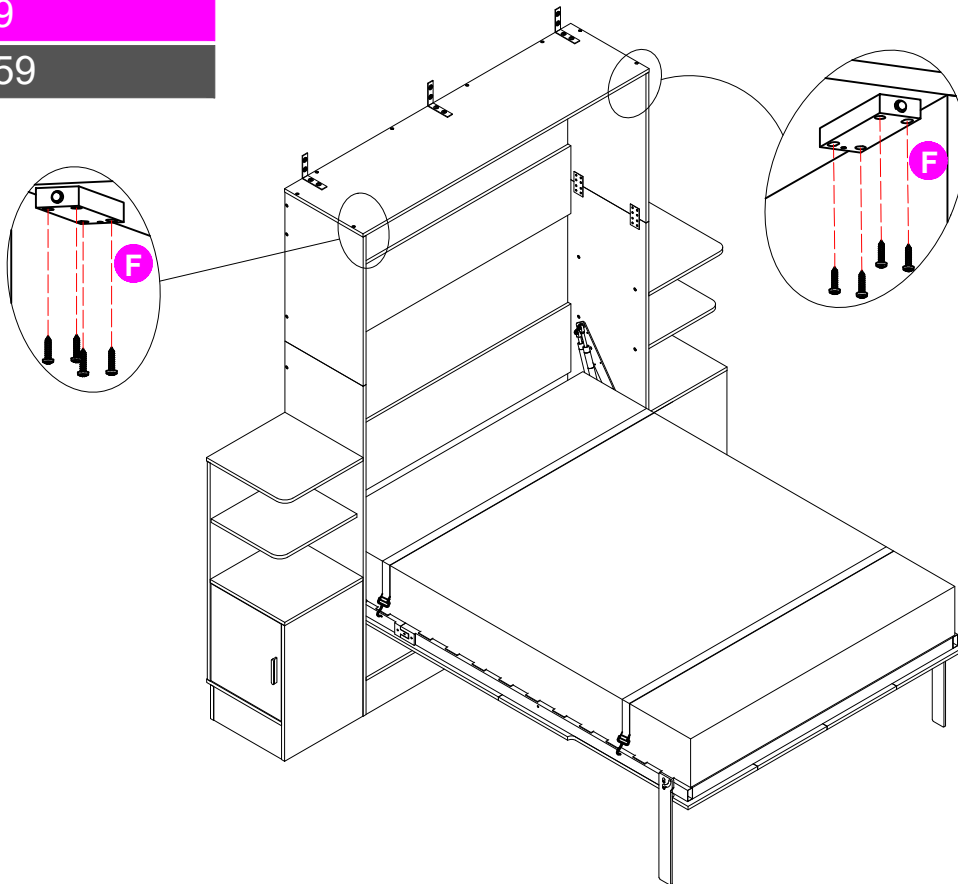

Step 60

Étape 60

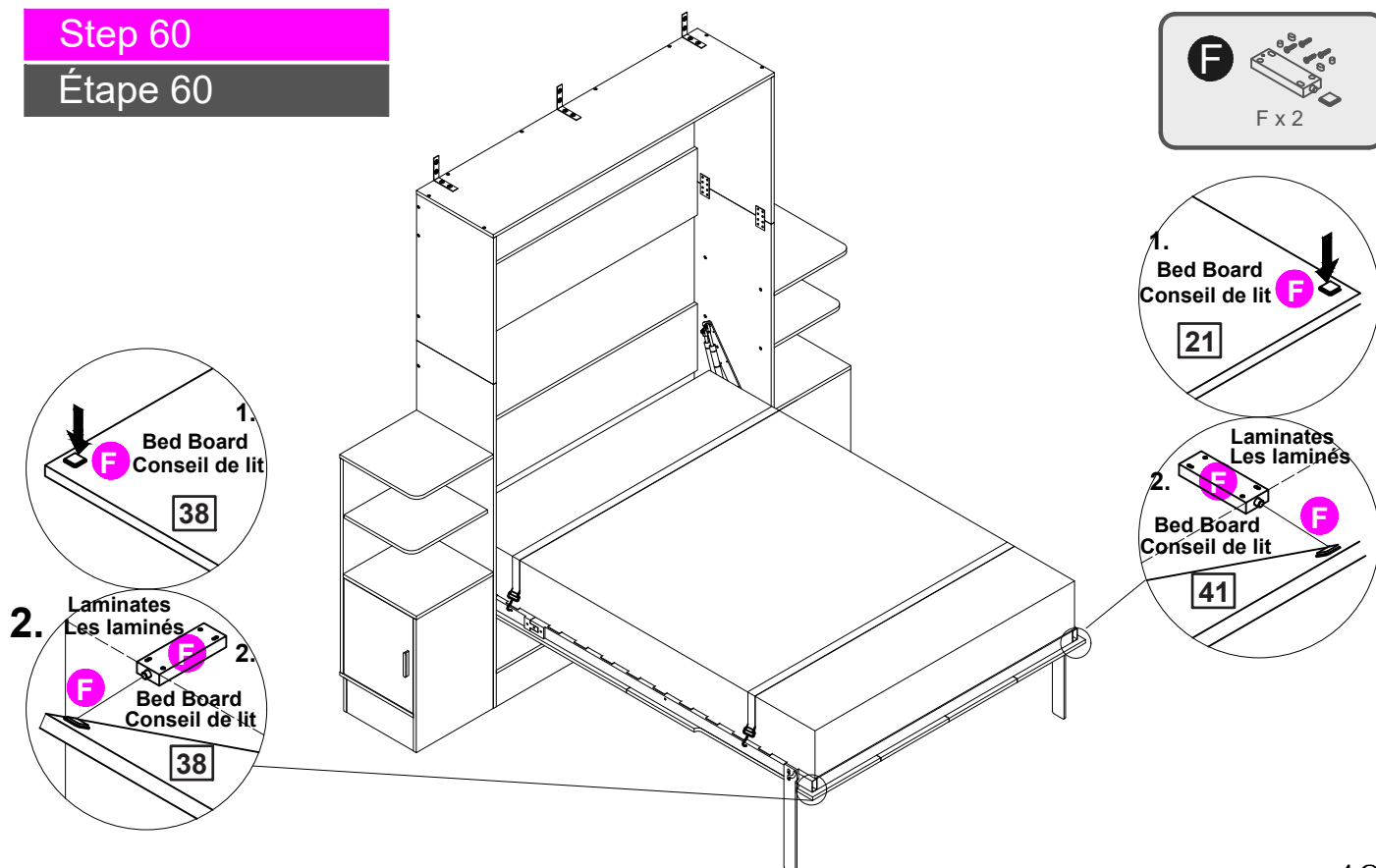

Assembly Instructions / Instructions de montage

Step 61

Étape 61

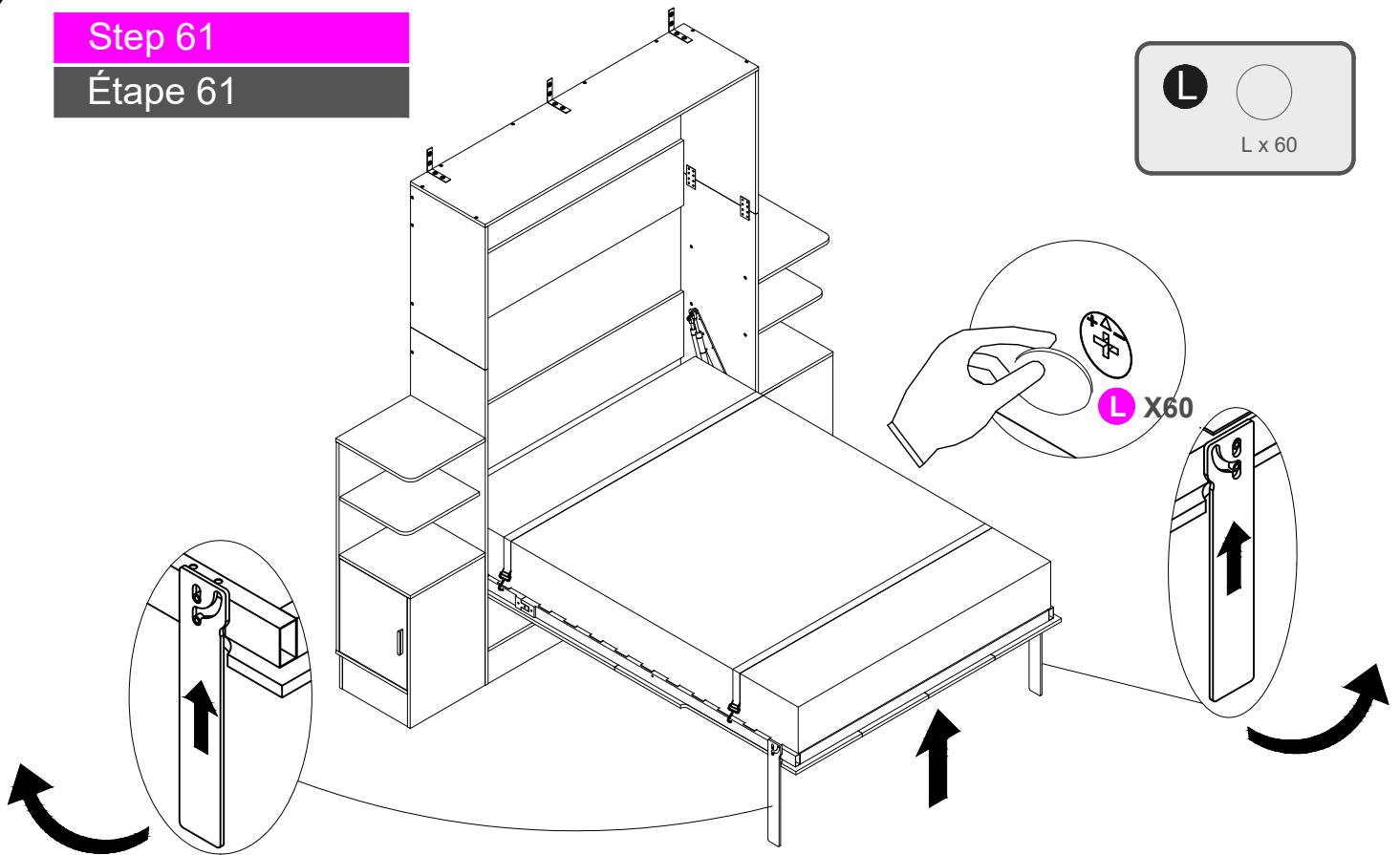

Step 62

Étape 62

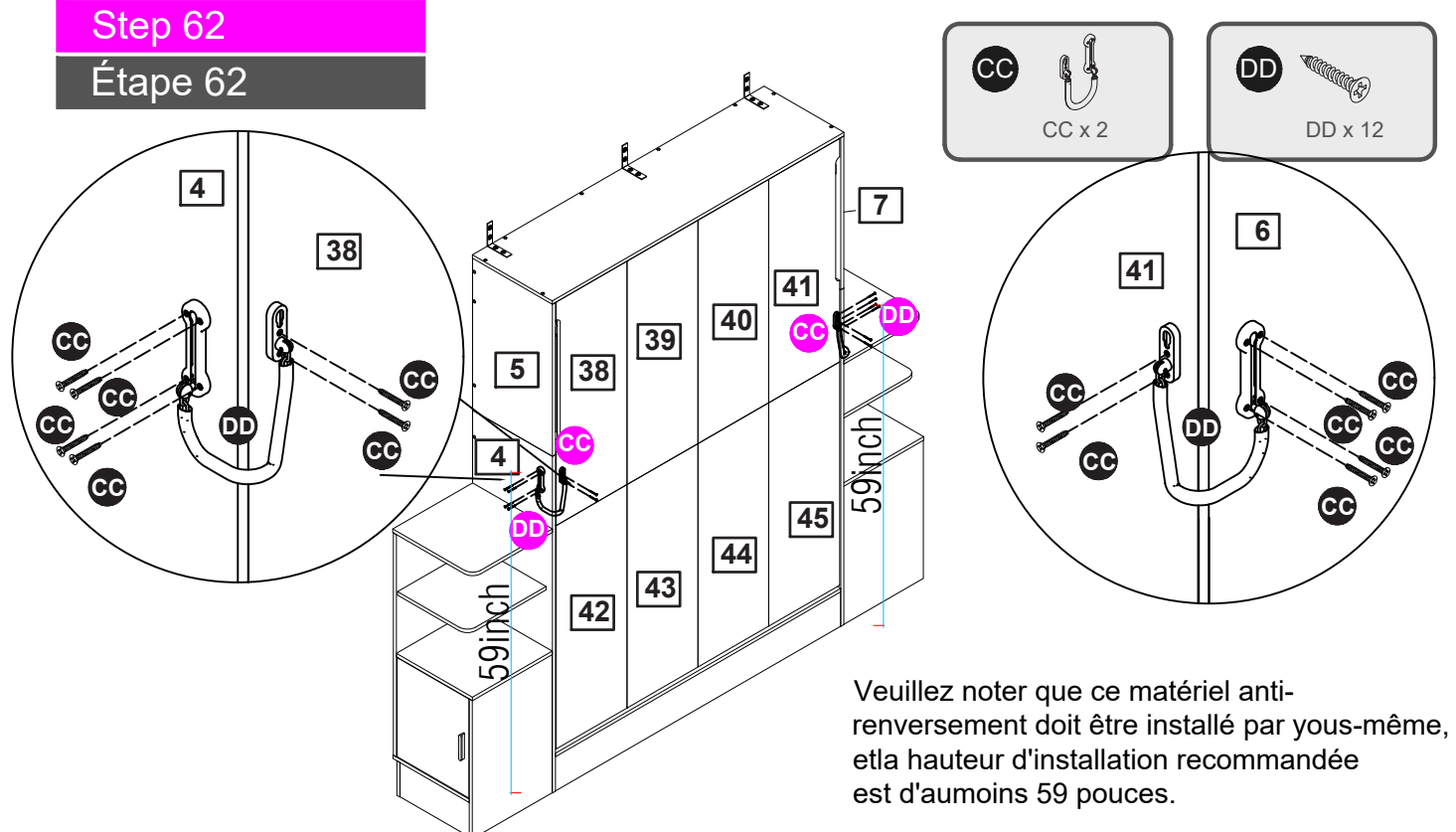

Veuillez noter que ce matériel anti-renversement doit être installé par vous-même, et la hauteur d'installation recommandée est d'au moins 59 pouces.

Please note that this anti-tip hardware should be installed by yourself, and the recommended installation height is not less than 59 inches.

Assembly Instructions / Instructions de montage

Step 63

Étape 63

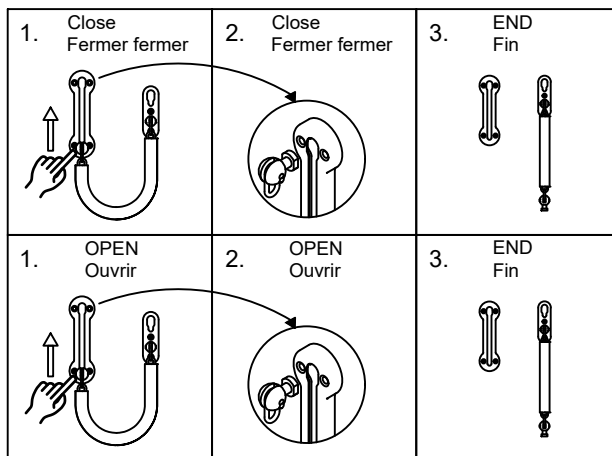
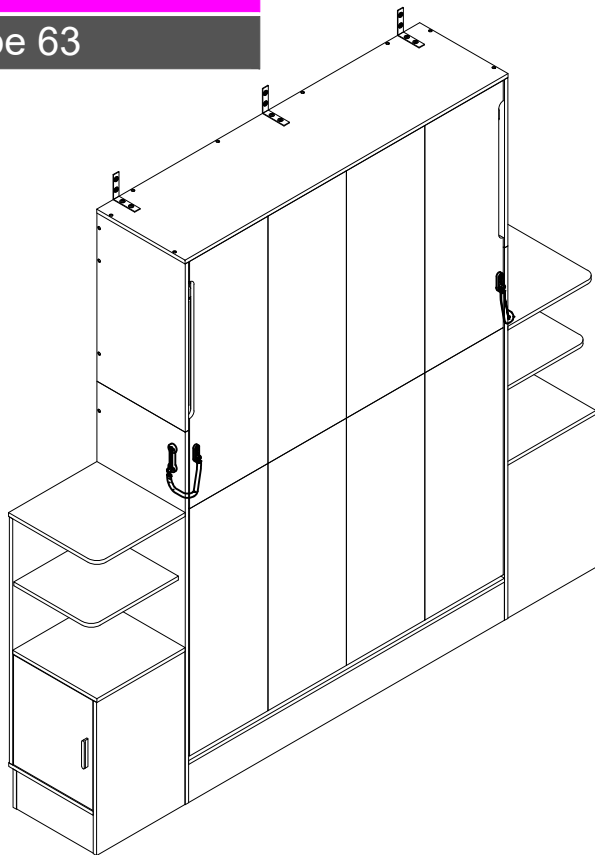

Step 64

Étape 64

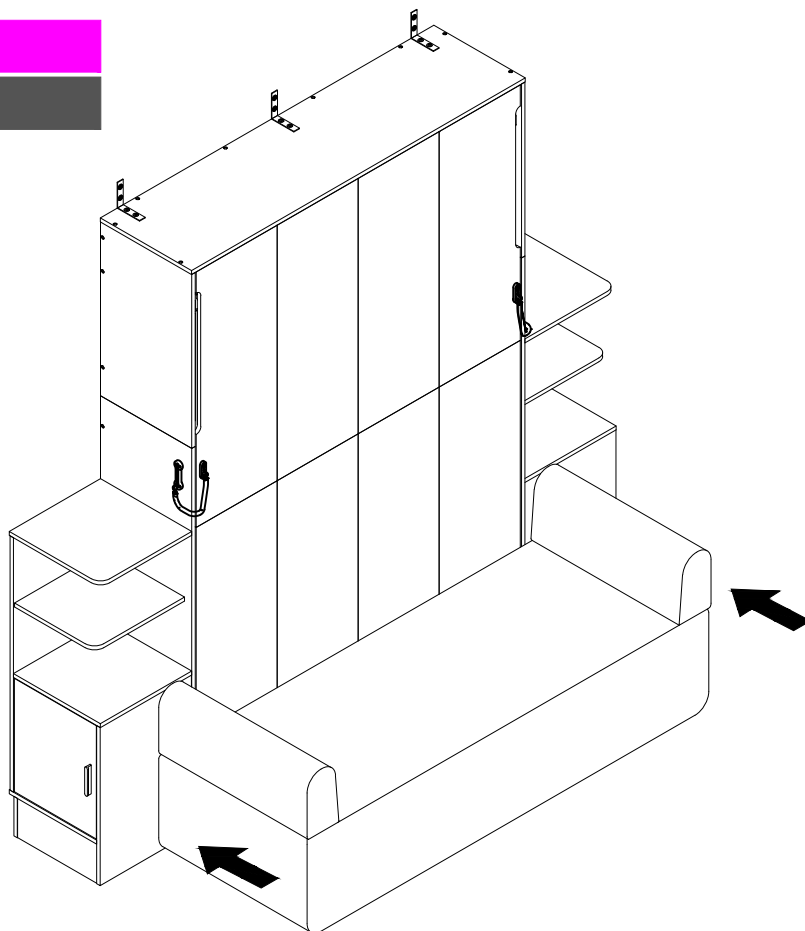

Assembly Instructions / Instructions de montage

Step 65

Étape 65

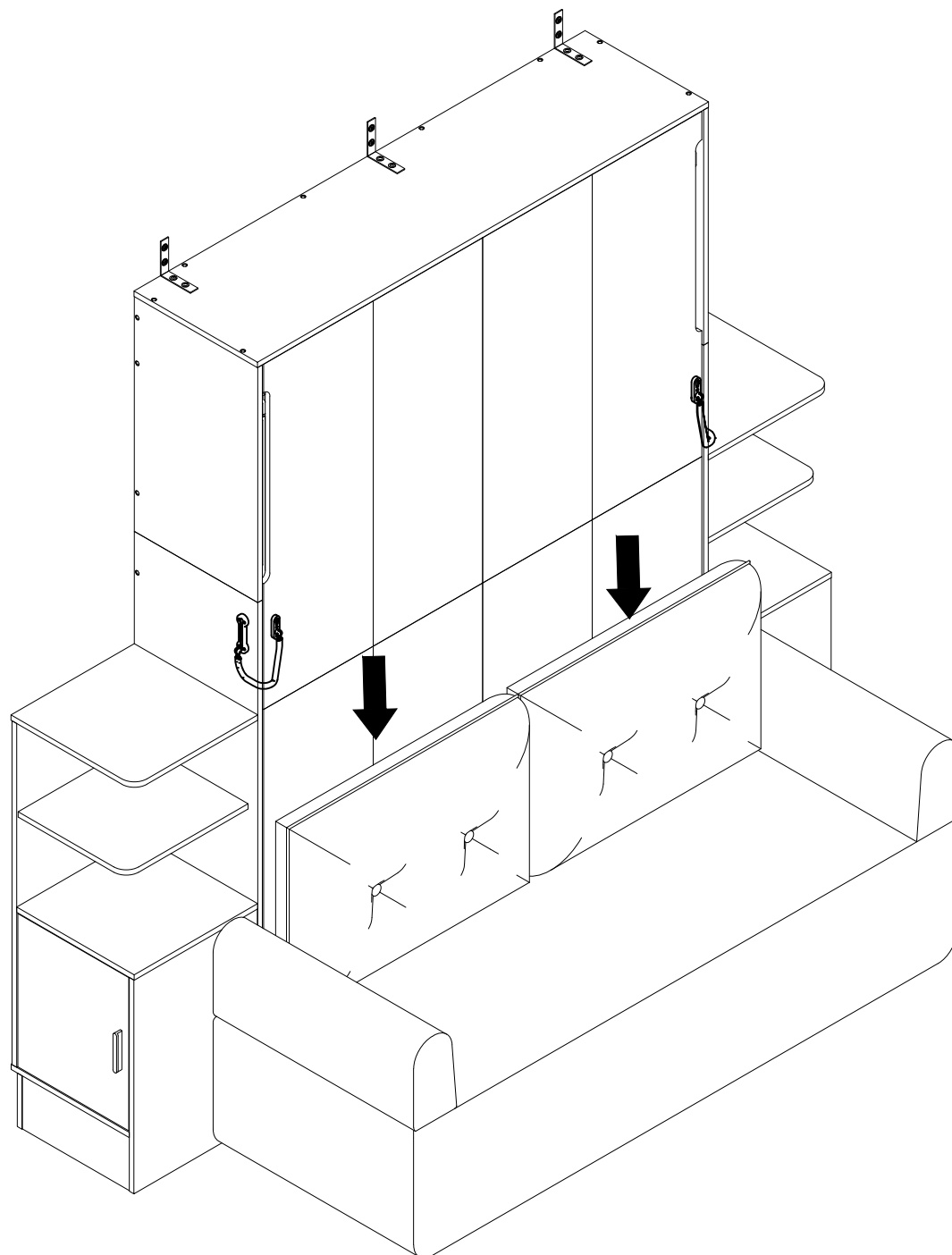

**Assembly is complete.
L'assemblage est terminé.**

The ways to adjust the door

- Before adjusting the hinge, please check whether the cabinet is skewed.
- If the skew can not be repaired, please remove the anti-tipping device first, then adjust the cabinet to vertical position.
- Please adjust the hinge with the door open.
- Please operate it with more than 2 people, one person holds the door and the other one adjusts the screw.

Components Name

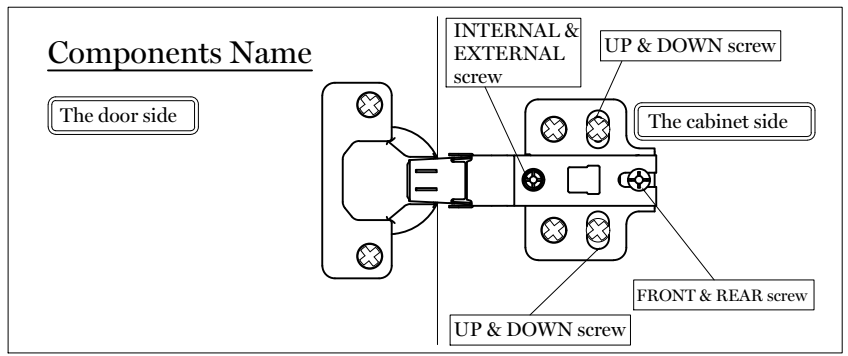

Obvious gaps between doors or Doors don't look closed

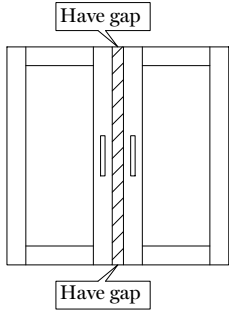

1 Turn "internal & external screw" to the right can make the door approach inside. Please adjust the doors little by little..

The left door

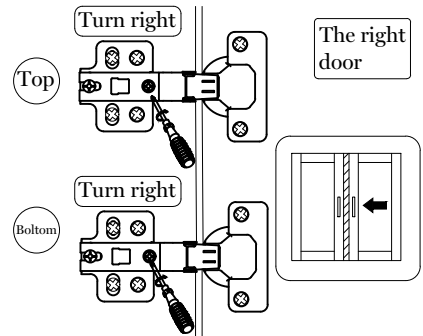
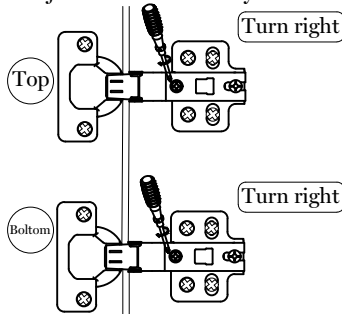

※ If the 2 doors are overlap, please turn the "internal & external screw" to the left.

When door is crooked

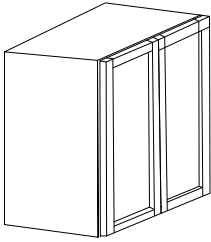

Please take the following steps to adjust first.

1 Rotate the "font and rear screws" to the left

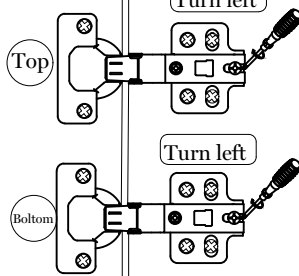

2 Push the door to the cabinet

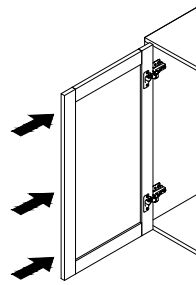

3 Rotate the "font and rear screws" to the right

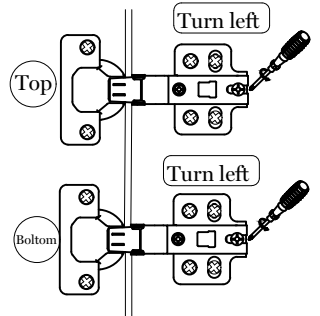

※ After adjusting the "front and rear screw", the door still does not change, please turn the "internal & external screw" to the right Slightly.

When door is leaning

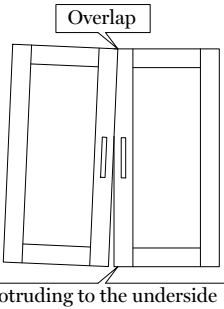

1 Turn "internal & external screw" to the left can make the top of the door tilted outward.

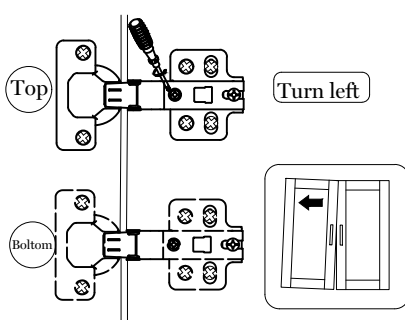

1 Turn "internal & external screw" to the left can make the top of the door tilted outward.

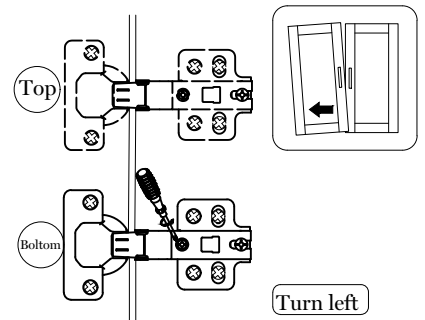
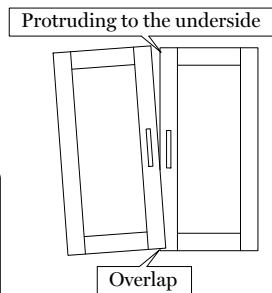

When door is higher on top

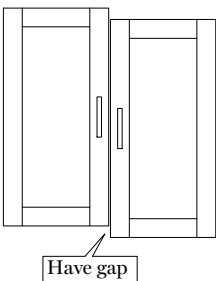

1 Turn "up & down screw" to the left

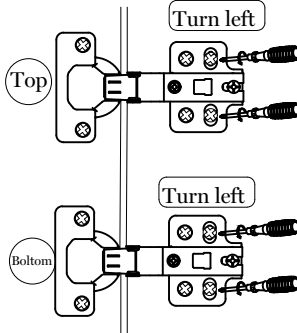

2 Lower the door's height so that 2 doors are of the same height.

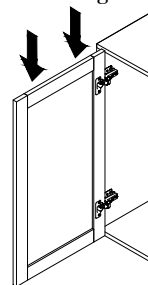

3 Turn "up & down screw" to the right

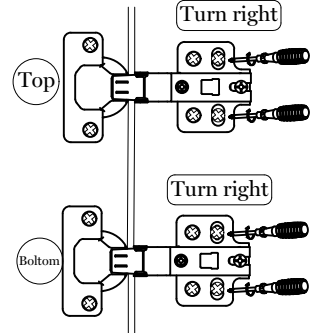

※ if the door is lower on bottom, please lift up the left door slightly on step 2