

# Assembly Instructions

## WARNING!!

Children have died from furniture tipover. Tip restraints have been included with this product; you must install the tip restraints according to these instructions in order to minimize the risk of furniture tipping. If you have any questions about this product or the tip restraint, please send us an email.

NEVER allow children to climb or hang on furniture, including drawers or cabinet doors.

In addition to installing the restraints, to help prevent tip-over:

1. NEVER put a TV or other heavy objects on top of this product.
2. Do not stand on the product.



<b>⚠ WARNING</b>	
	<p>Children have died from furniture tipover. To reduce the risk of furniture tipover:</p> <ul style="list-style-type: none"><li>• ALWAYS install tipover restraint provided.</li><li>• NEVER put a TV on this product.</li><li>• NEVER allow children to stand, climb or hang on drawers, doors, or shelves.</li><li>• NEVER open more than one drawer at a time.</li><li>• Place heaviest items in the lowest drawers.</li></ul> <p><i>This is a permanent label. Do not remove!</i></p>
	

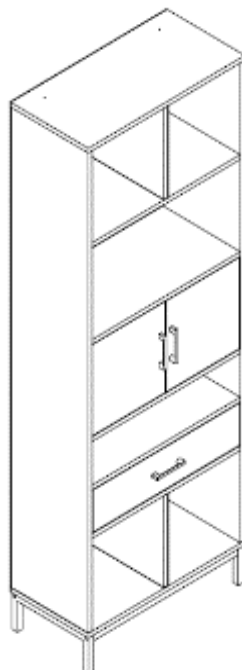

**Caution: You must read this before you proceed**



## Bookcase

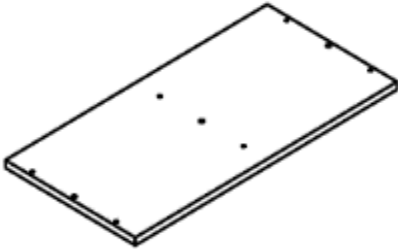
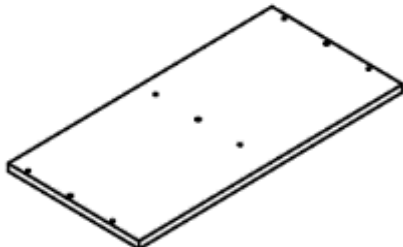
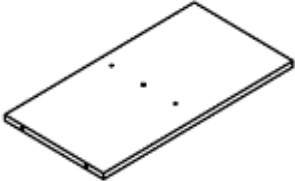
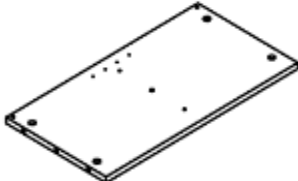
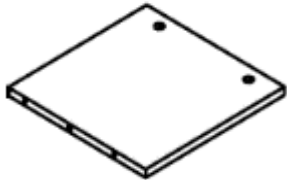
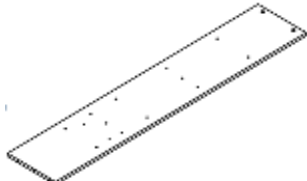

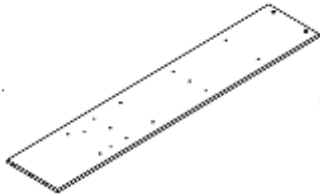
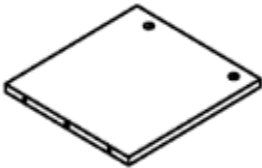
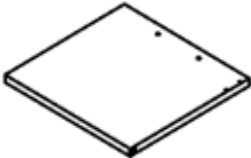
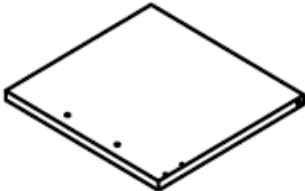
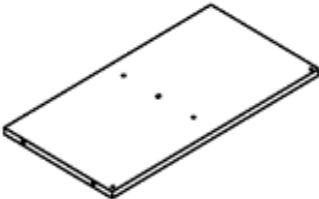
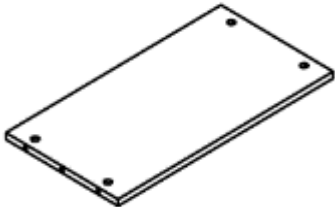
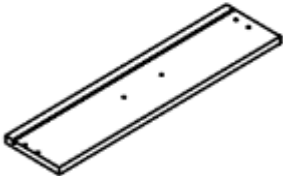

# Parts List

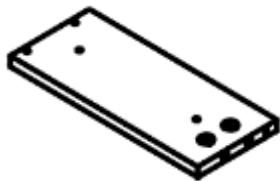

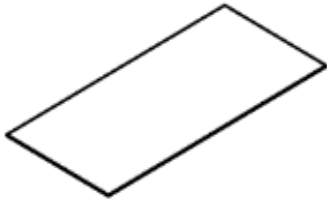
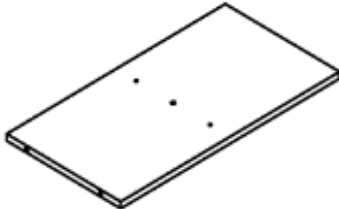
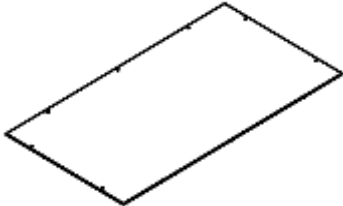
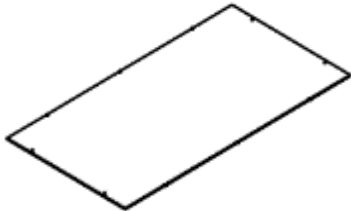









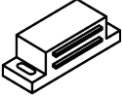

Label	Picture	Description	QTY
A		Side Frame	2
B		Transversal Tube	2
C		Top Panel	1
D		Bottom Panel	1
E		Shelf	1
F		Middle Shelf	1
G		Divider	2
H		Left Panel	1

I		Right Panel	1
J		Middle Divider	1
K		Left Door	1
L		Right Door	1
M		Shelf under Door	1
N		Shelf above Drawer	1
O		Front Panel of Drawer	1
P		Left Panel of Drawer	1



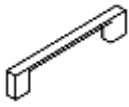



Q		Right Panel of Drawer	1
R		Back Panel of Drawer	1
S		Bottom of Drawer	1
T		Shelf under Drawer	1
U		Back Wall at Top and Bottom	2
V		Back Wall at Middle	3

## Hardware

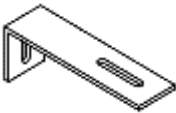
Label	Picture	Description	QTY
①		Cam Lock	23
②		Cam Bolt	23
③		Wooden Dowel	27

④		Bolt (M6*30mm)	13
⑤		Bolt (M4*20mm)	7
⑥		Screw (M4*40mm)	15
⑦		Door Hinge	5
⑧		Magnet	2
⑨		Screw (M3*16mm)	5
⑩		Screw (M3*12mm)	5
⑪		Screw (M3.5*12mm)	9
⑫		Hex Key	1
⑬		<b>Screw</b> (M3*12mm)	39
⑭		Handle	3
⑮		Holes Cover	23
⑯		Drawer Slides	<b>2</b>
⑰		Magnetic Bar	2

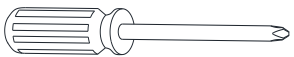
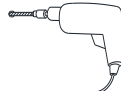







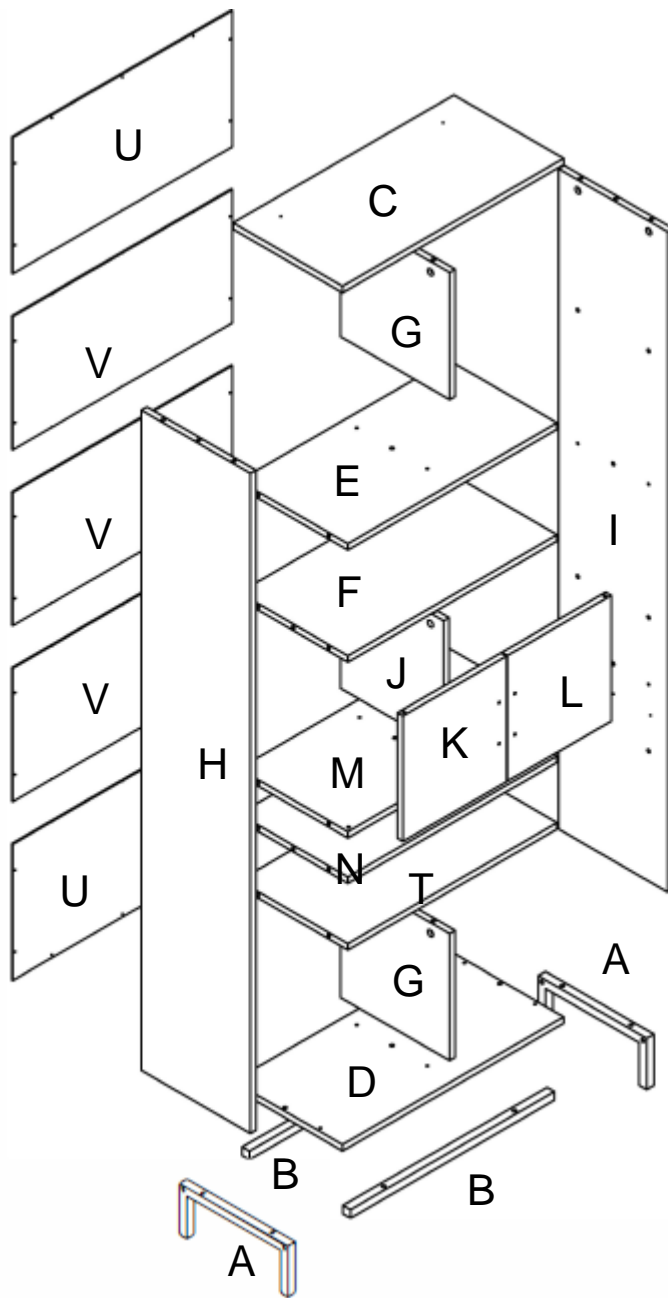







## Cabinet Restraint Device Hardware

⑱		L-shape Metal Brackets	2
⑲		Screws (M4*35mm)	3
⑳		Screws (M4*15mm)	3
㉑		Plastic Dowel	3
㉒		Screwdriver (Not provided)	1
㉓		Power Drill (Not provided)	1
㉔		Hammer (Not provided)	1

# Assembly Preparation

Before Beginning Assembly:



-  \*23
-  \*5
-  \*23
-  \*5
-  \*27
-  \*9
-  \*13
-  \*1
-  \*7
-  \*39
-  \*15
-  \*3
-  \*5
-  \*23
-  \*2
-  \*2
-  \*2

-  \*2
-  \*3
-  \*3
-  \*3



- Read instructions, cover to cover-
- Have 2 adults on hand for assembly-
- Do not assemble on flooring or carpet-
- Assemble on a clean non-marring surface (packing foam)-
- Save all packaging until finished-

# Assembly Steps

## Overview

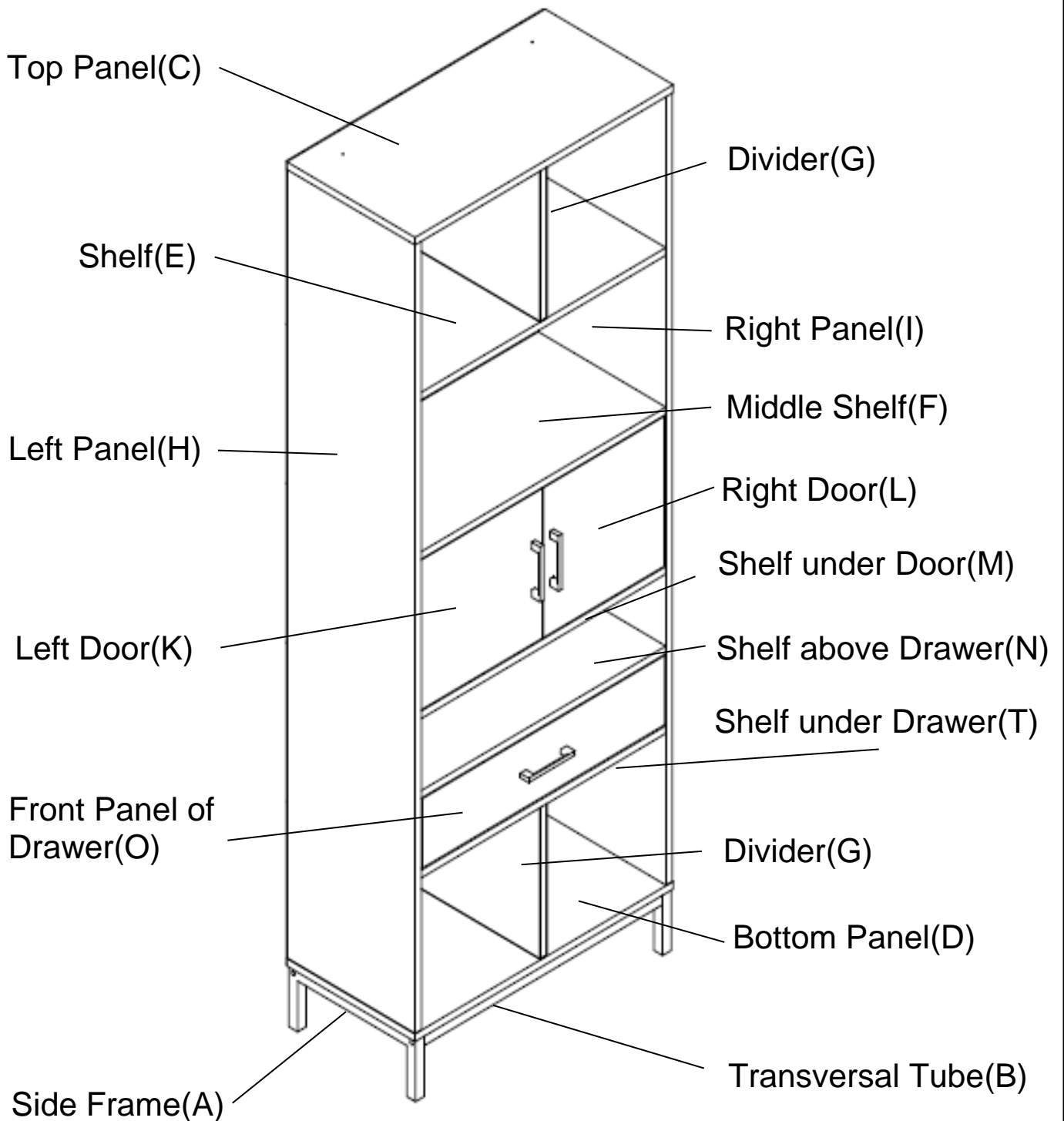

This Bookcase has multiple parts and may require up to 30 minutes to assemble. To give you an overview of the Bookcase parts, the above picture is to help you put the various parts into perspective. Please read through the instructions herebelow to familiarise the parts and steps before assembly.

## Step 1

- 1) Pull toward arrow to open the slide until its stops and then flip it over.



- 2) Push plastic lever down and pull apart.



Cabinet member

**a**



Drawer member

**b**



Open the carton and place all parts onto a clean, non-marring surface.  
Split up the Drawer Slides(16) into a and b.

## Step 2

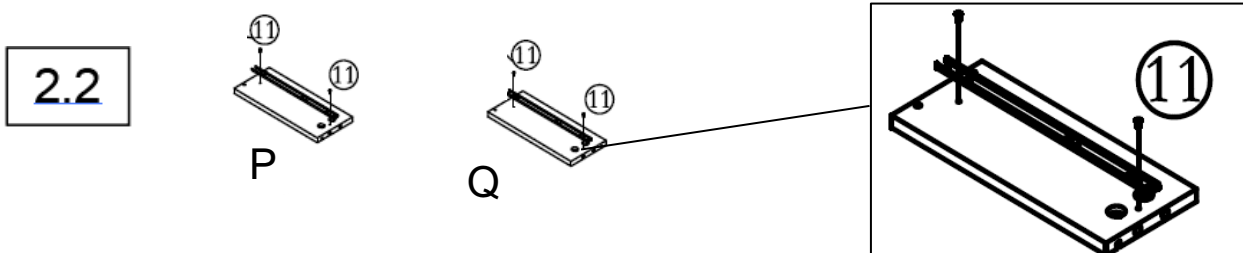
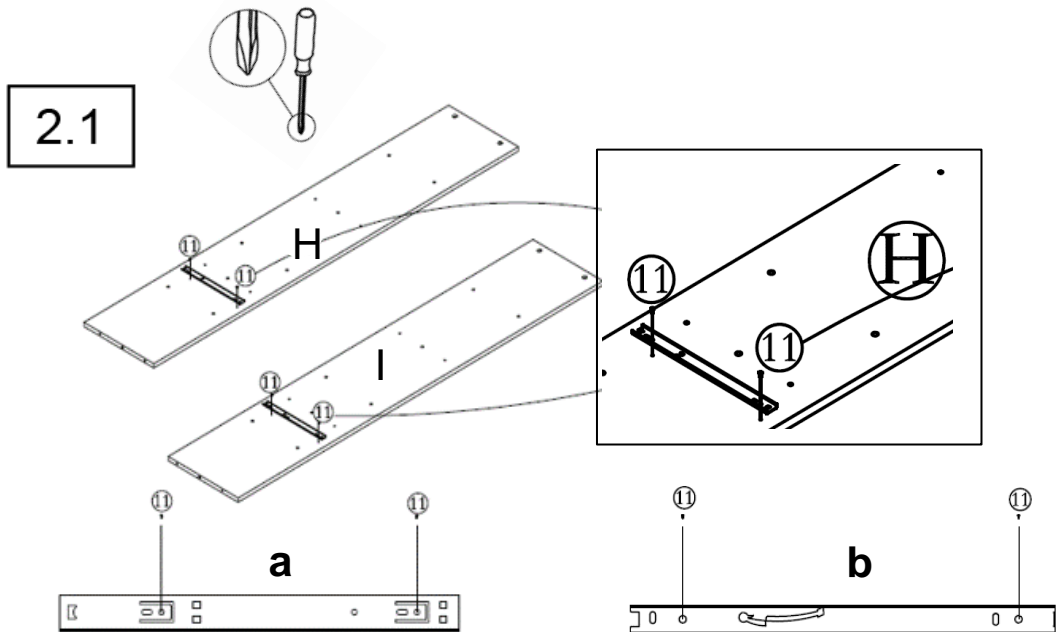

2.1) Attach part a of Drawer Slides (16) to Left panel(H) and Right panel(I) using screw(11)with Screwdriver(22)

2.2) Attach part b of Drawer Slides(16) to Left Panel of Drawer(P) and Right Panel of Drawer(Q) using screw(11) with Screwdriver(22)

### Step 3

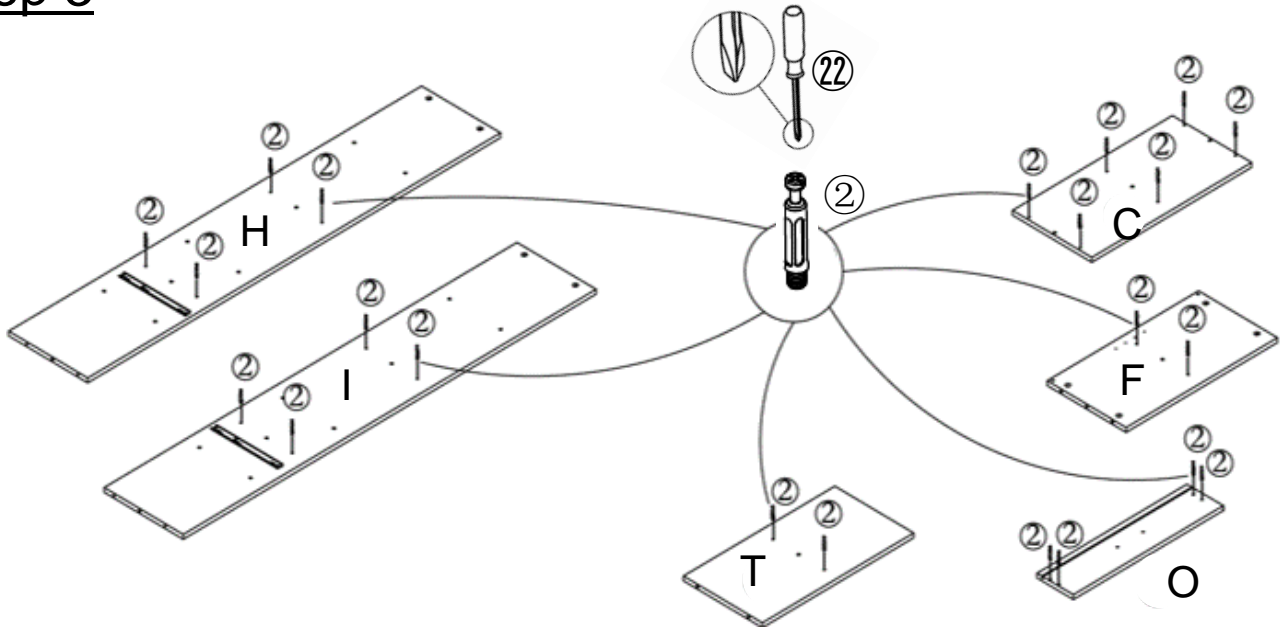

Insert Cam Bolt(2) into the mounting positions of H,I,C,F,O,T,as shown, lock by turning Cam Bolt(2) with Screwdriver(22)

### Step 4

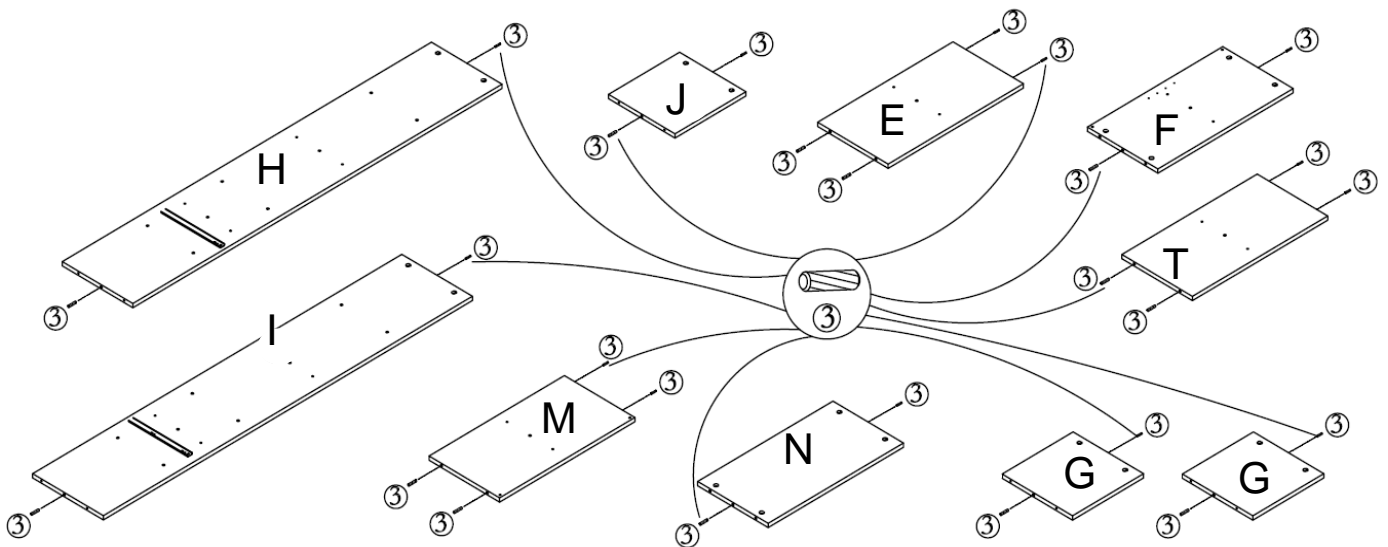

Insert Wooden Dowel(3) into mounting positions on E,F,G,H,I,J,M,N,T as shown.

## Step 5

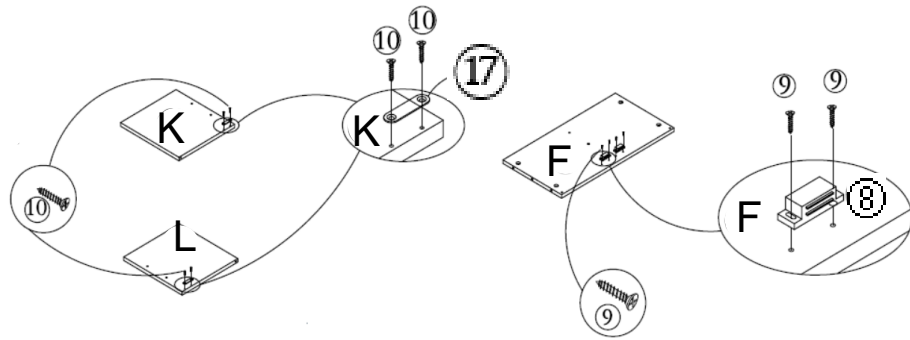

- 5.1) Attach Magnet(⑧) to Middle Panel(F) using Srew(⑨) with Screwdriver(②②) .
- 5.2) Attach Magnet(⑰) to Left Door(K) and Right Door(L) using Srew(⑩) with Screwdriver(②②).

## Step 6

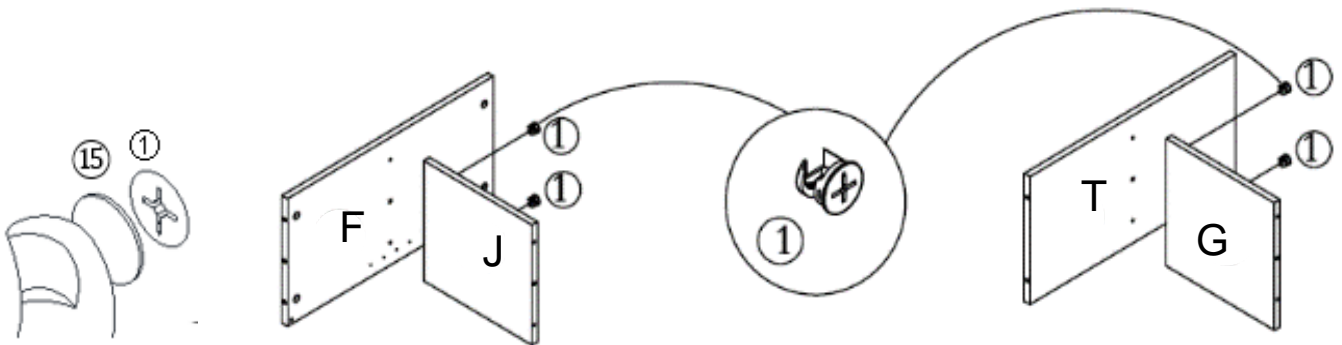

- 6.1) Insert Wooden Dowel on Divider(J) into the mounting positions on Middle Shelf(F), and Insert Cam Bolt on Middle Shelf(F) into the mounting positions on Divider(J), then Insert Cam Lock(①) into the mounting positions of Middle Divider(J). Lock by turning Cam Lock(①) with Screwdriver(②②). Use Holes cover(⑮) to cover the mounting position of Cam Lock(①).
- 6.2) Insert Wooden Dowel on Divider(G) into the mounting positions on Shelf under Drawer(T), and Insert Cam Bolt on Shelf under Drawer(T) into the mounting positions on Divider(G), then Insert Cam Lock(①) into the mounting positions of Divider(G). Lock by turning Cam Lock(①) with Screwdriver(②②). Use Holes cover(⑮) to cover the mounting position of Cam Lock(①).

**Note: Ensure the arrows on Cam Locks head points towards the Cam Bolt mounting positions.**

## Step 7

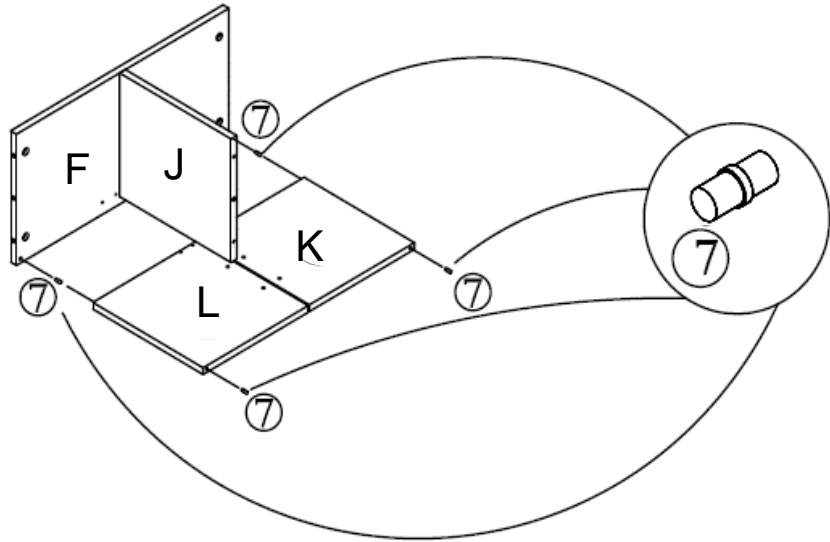

7.1) Attach Door Hinge(⑦) to the two sides of Left door(K) and Right door(L) as shown.

7.2) Insert one side of Door Hinge on Left door(K) and Right door(L) into the mounting position on Middle Shelf(F).

## Step 8

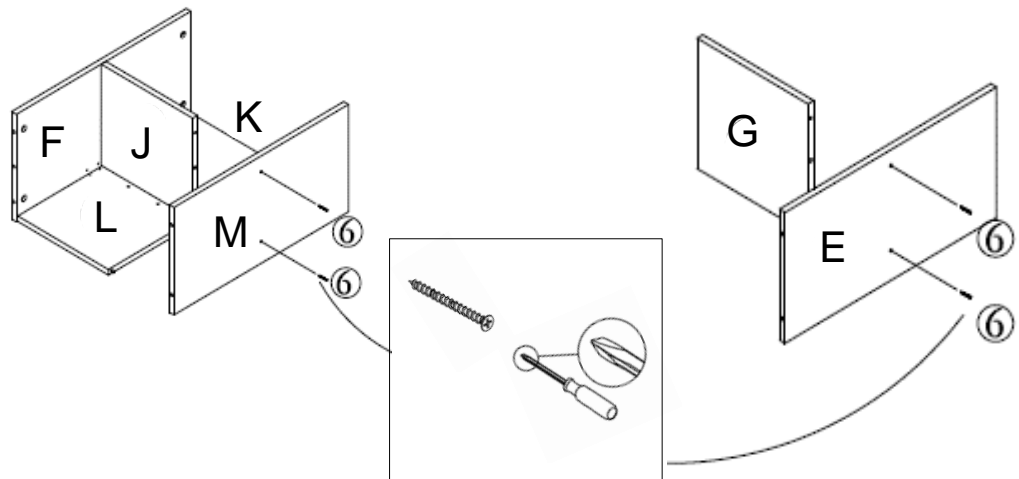

8.1) Insert the other side of Door Hinge on Left door(K) and Right door(L) into the mounting position on Shelf under Door(M). And insert the Wooden dowel on Shelf under Door(M) into Middle Divider(J) at the same time. Attach Shelf under Door(M) to Middle Divider(J) using Screw(⑥) with Screwdriver(⑳).

8.2) Insert the Wooden dowel on Divider(G) into Shelf(E), attach Shelf(E) to Divider(G) using Screw(⑥) with Screwdriver(⑳).

## Step 9

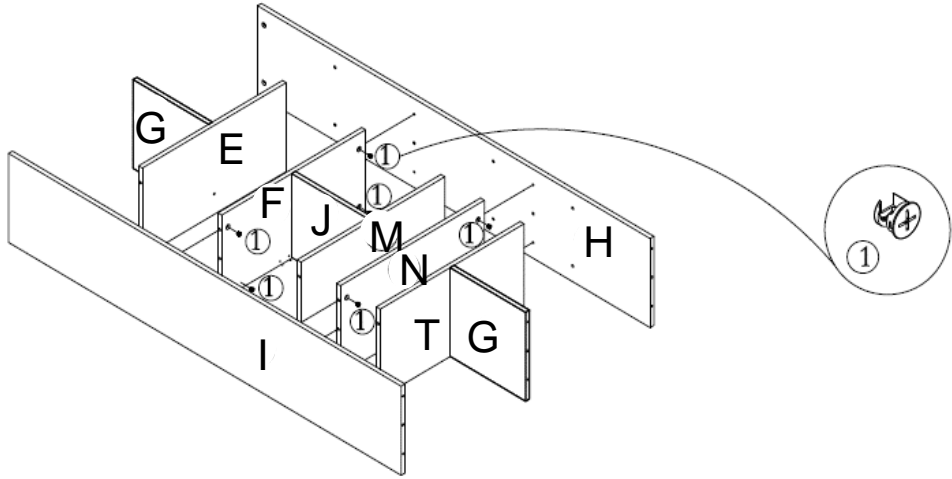

9.1) Insert Wooden Dowel on Shelf(E),Middle Shelf(F),Shelf under Door(M),Shelf above Drawer(N),Shelf under Drawer(T) into the mounting positions on Left Panel(H) and Right Panel(I),and insert Cam Bolt on Left panel(H) and Right panel(I) into the mounting positions on Middle Shelf(F), Shelf above Drawer(N). Insert Cam Lock(①) into the mounting positions on Middle Shelf(F), Shelf above Drawer(N), lock by turning Cam Lock(①) with Screwdriver(⑳) as shown.

9.2) Use Holes cover(⑮) to cover the mounting position of Cam Lock(①).

## Step 10

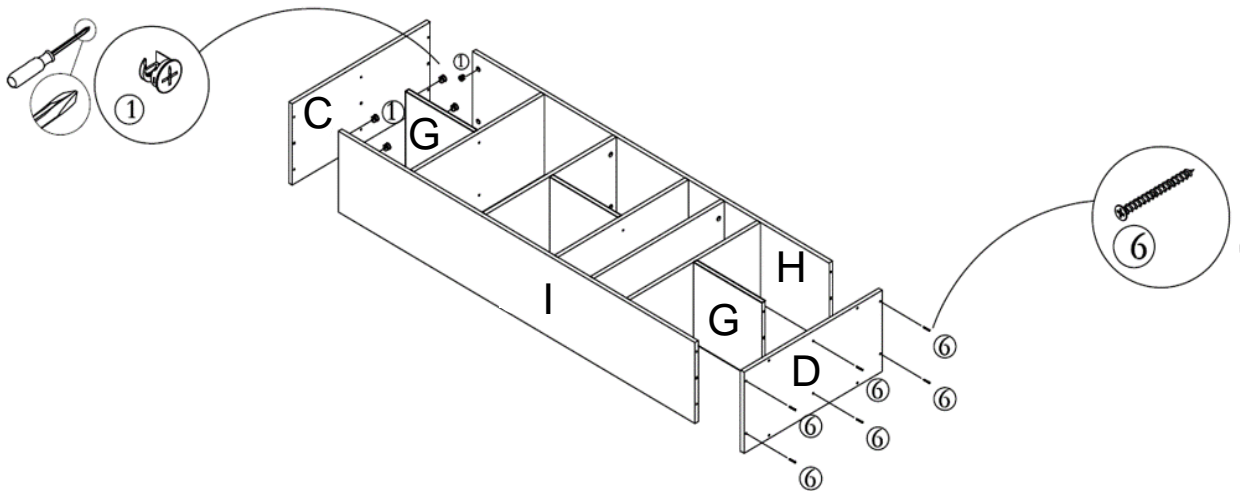

10.1) Insert Wooden Dowel on Left panel(H),Right Panel(I) and Divider(G) into the mounting positions on Top panel(C) and Insert Cam Bolt on Top panel(C) into the mounting positions on Left panel(H), Right Panel(I) and Divider(G). Lock by turning Cam Lock(①) with Screwdriver(⑳).

10.2) Insert Wooden Dowel on Left panel(H),Right Panel(I) and Divider(G) into the mounting positions on Bottom panel(D). Attach Bottom panel(D) to Left panel(H),Right Panel(I) and Divider(G) by using Screw(⑥) with Screwdriver(⑳).

10.3) Use Holes cover(⑮) to cover the mounting position of Cam Lock(①).

## Step 11

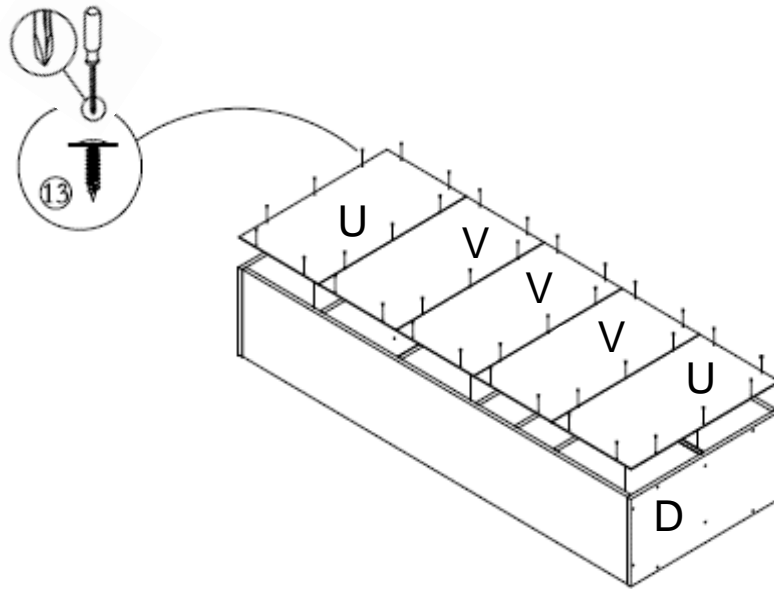

Attach Back Wall at Top and Bottom(U) and Back Wall at Middle to the frame of bookcase using Screw(13) with Screwdriver(22).

## Step 12

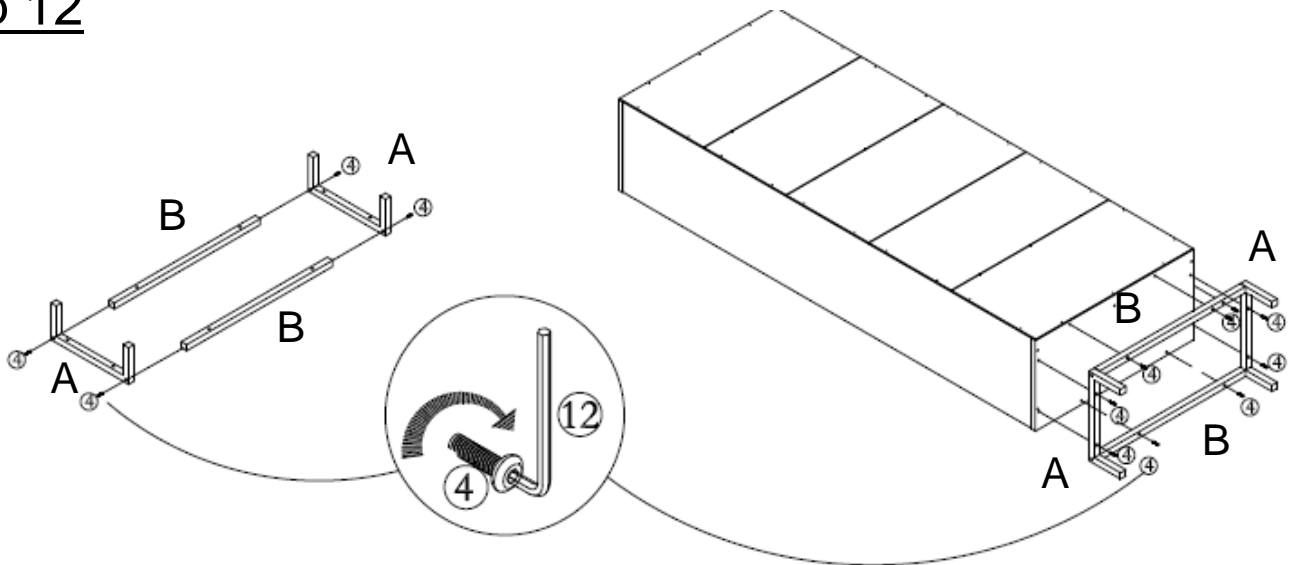

12.1) Attach Side Frame(A) to Transversal Tube(B) using Bolt(4) with Hex Key(12).  
12.2) Attach Transversal Tube(B) to Bottom Panel(D) using Bolt(4) with Hex Key(12) as shown.

## Step 13

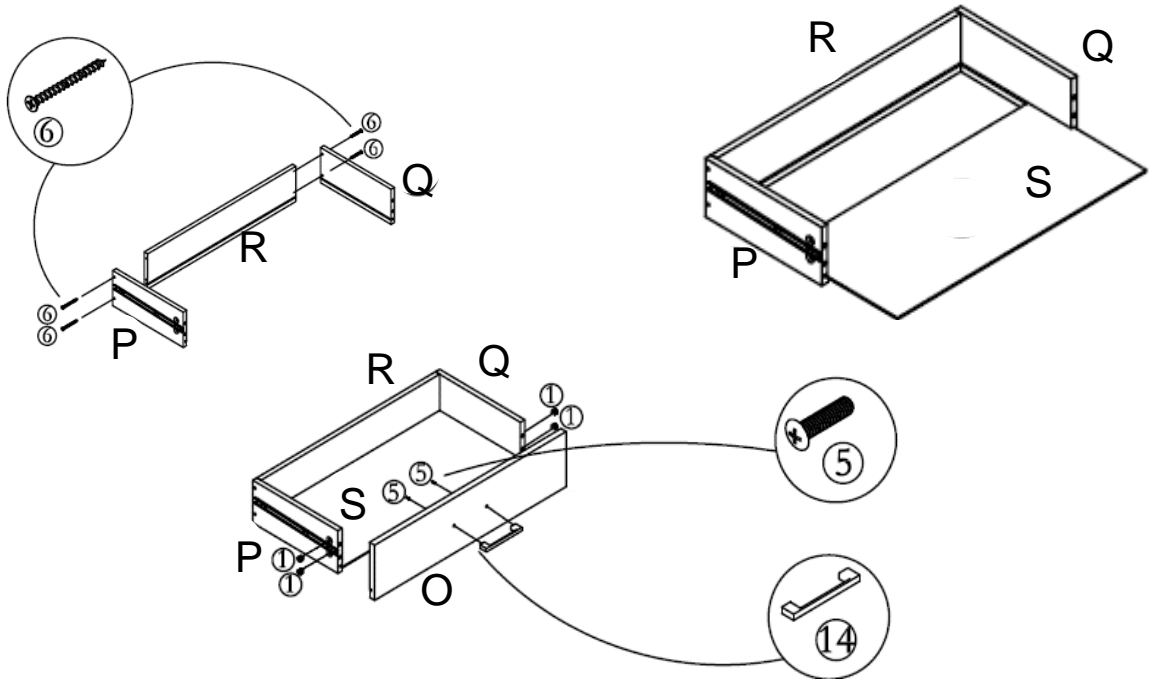

13.1) Attach Left Panel of Drawer(P) and Right Panel of Drawer(Q) to Back Panel of Drawer(R) using Screw(⑥) with Screwdriver(②).

13.2) Insert Bottom of Drawer(S) into the grooves between Left Panel of Drawer(P) and Right Panel of Drawer(Q).

13.3) Insert Cam Bolt on Front Panel of Drawer(O) into the mounting positions on Left Panel of Drawer(P) and Right Panel of Drawer(Q). Insert Cam Lock(①) into the mounting positions on Left Panel of Drawer(P) and Right Panel of Drawer(Q). Lock by turning Cam Lock(①) with Screwdriver(②).

13.4) Use Holes Cover(⑮) to cover the mounting positions of Cam Lock(①).

13.5) Attach Handle(⑭) to Front Panel of Drawer(O) using Bolt(⑤) with Screwdriver(②)

## Step 14

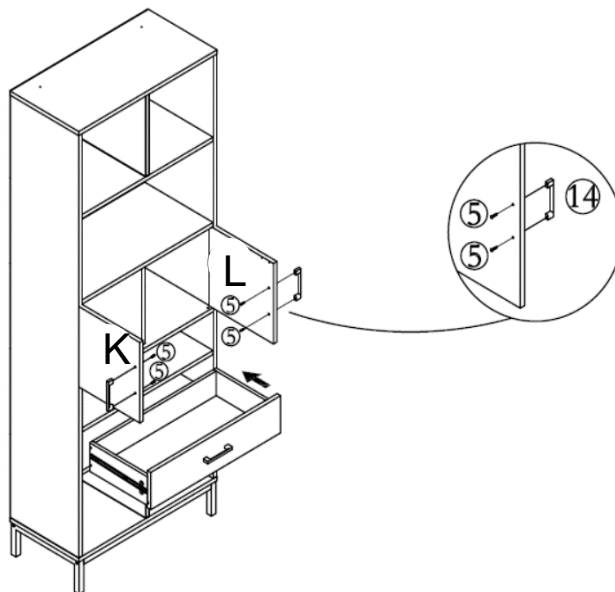

14.1) Attach Handle(⑭) to Left Door(K) and Right Door(L) using Bolt(⑤) with Screwdriver(②).

14.2) Put the Drawer Member on the Drawer to Cabinet Member on the Bookcase, then carefully push Drawer into the Bookcase.



## WARNING

Serious or fatal crushing injuries can occur from tipping furniture. To help prevent tip-over: **ALWAYS** secure this furniture to the wall using Cabinet Restraint Device.

See product instructions for more ways to help prevent furniture tip-over.

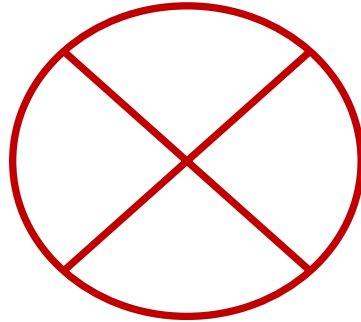

### Usage For Cabinet Restraint Device:

#### Step 15

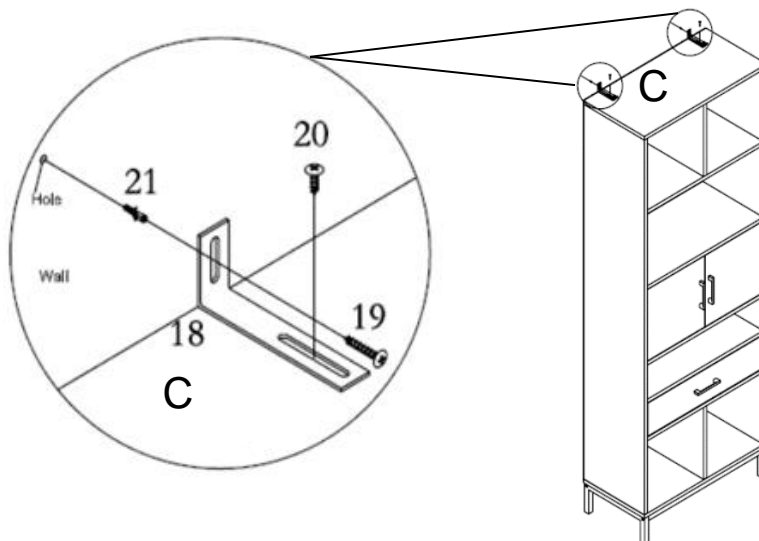

15.1) Use Power Drill(23) Drill two mounting positions on wall at same height, insert Plastic Dowel(21) into the mounting position with a Hammer(24)(Not provided).

13.2) Attach L-shape Metal Sheet(18) to plastic Dowel(21) using Screw(19) with Screwdriver(22).

Note: The Metal sheet need to be secured to solid, load bearing surface. Please use a Stud Finder(not supplied) if needed to locate the Wall Frame.

13.3) Attach L-shape Metal Sheet(18) to Top Panel(A) using Screw(20) with Screwdriver(22).

Your Bookcase is ready for use.

This Bookcase can only be used on a flat, level surface.

## Care & Maintenance



- Furniture may scratch floors. We recommend using furniture pads to protect your floors.



- Do not put hot items directly on furniture surface.



- Do not clean furniture with harsh cleansers or polish.



- Do not place furniture under direct sunlight.



- Do not place furniture near heating or cooling vents.



- Do not write on furniture without a padded barrier to protect the surface.



- Do not place furniture outside . For indoor use only.



- Not for commercial use. For residential use only.



- Stains may be removed with mild soap solution and damp cloth.



- Children should not climb or jump on the furniture.



- Dust and pick-up spills using a clean, non-colored, lint-free cloth.