

Installation & Assembly

Vanity Light

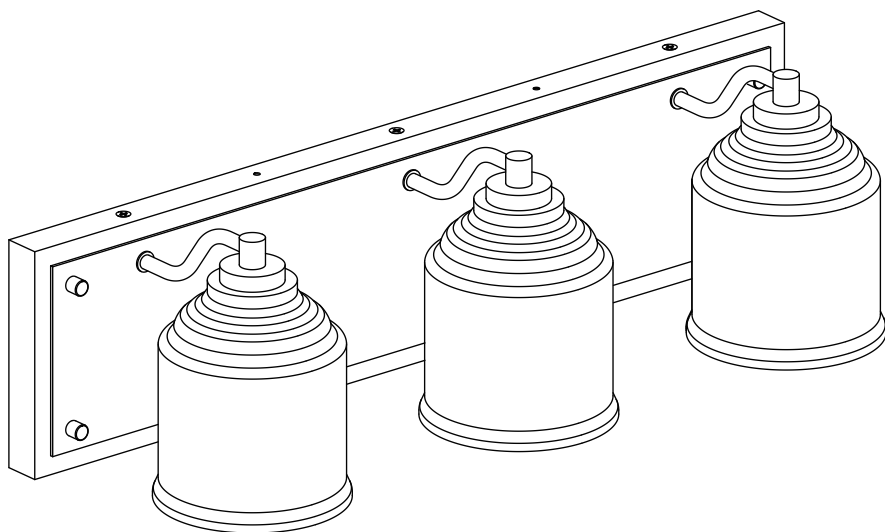

General Guidelines

- Please pay attention to the warning signs.
- Please read the instructions with caution before operating and keep it properly.
- This summary may not include every detail of all variations and considered steps. Please feel free to contact us if further information and help are needed.

Warning

1. Inspect the wire insulation for any cuts, abrasions, or exposed copper that may have resulted during shipping. If there is a defect in the wire, do not attempt installation.
2. Before starting installation of this fixture or removal of a previous fixture, disconnect the power by turning off the circuit breaker or by removing the fuse at the fuse box.

Please follow the below steps:

FIG. 1. Place the wall switch to the "OFF" position.

Depending on which type of fuse box you have in your home.

FIG. 2. Place either the main (Master) switch to the "OFF" position, cutting off power to your entire home OR turn off the individual switch that provides power to where the fixture will be installed.

OR

FIG. 3. Place either the main (Master) switch to the "OFF" position, cutting off power to your entire home OR unscrew the fuse that provides power to where the fixture will be installed.

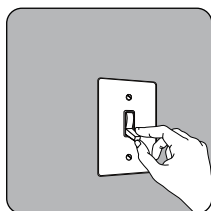

FIG.1 WALL SWITCH

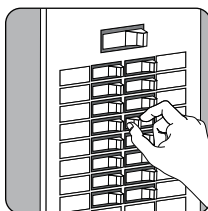

FIG.2 BREAKER PANEL

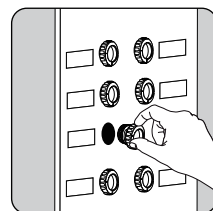
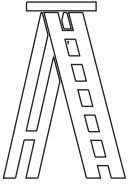

FIG.3 FUSE BOX

3. Before cleaning the fixture, turn off the switch or power source. Wipe the fixture with a soft and dry cloth.

4. DO NOT try to repair or disassemble the unit. Doing so could damage the unit and cause possible electrical shock. Consult a qualified electrician if needed. Seller assumes no responsibility or liability for any damage caused by incorrect assembly, improper operation or improper use.
5. Keep packing materials away from children to prevent choking and suffocation.

TOOLS REQUIRED



Ladder

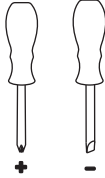

Screwdriver

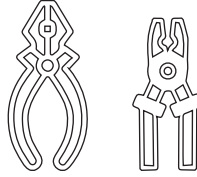

Pliers/Wire strippers

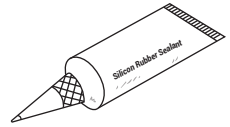

Silicon Rubber Sealant



Safety goggles



Electrical tape

PARTS INCLUDED

<p>Fixture</p>	<p>Glass Shades</p>	<p>Mounting Bracket</p>	<p>Socket Rings</p>	
<p>Outlet Box Screws</p>	<p>Expansion Screws</p>	<p>Screws</p>	<p>Ball Nuts</p>	<p>Wire Connectors</p>

Please check if the parts are intact before starting the assembly.

Exploded

