

Hall Tree - Arbre à

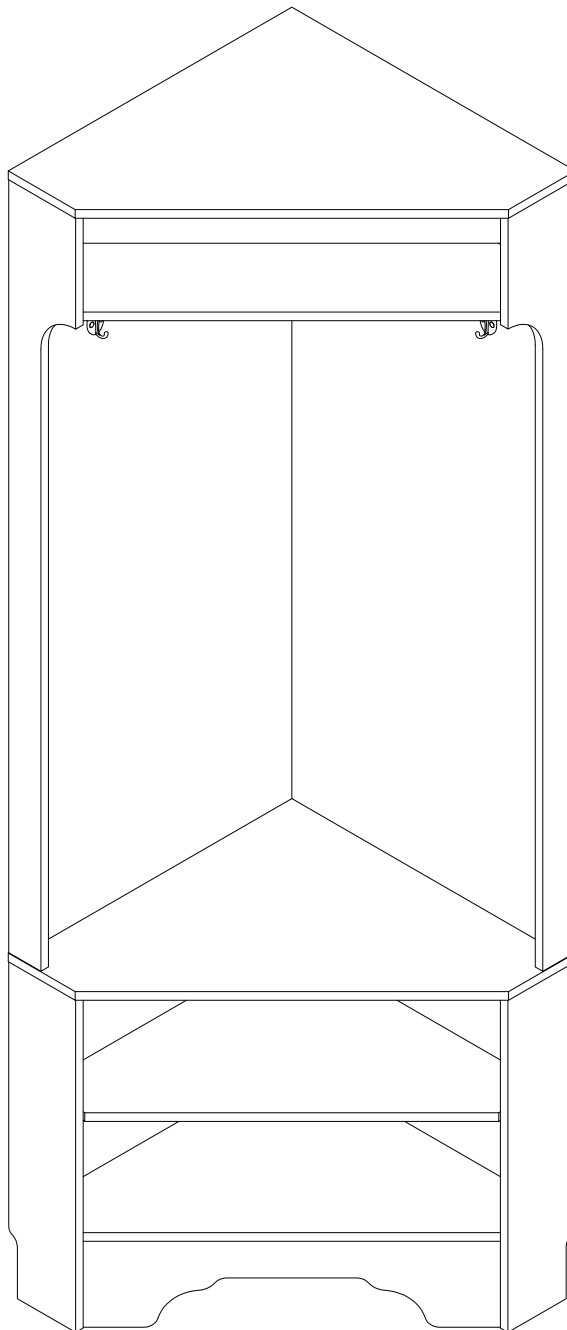

Dimensions

Width/Largeur: 53.9inch/pouce
Depth/Profondeur: 24.8inch/pouce
Height/Hauteur: 5.7inch/pouce

⚠ WARNING/AVERTISSEMENT



This product is NOT a Clothing Storage Unit (CSU).
Ce produit n'est PAS une unité de rangement pour vêtements (CSU).
DO NOT use it for clothing storage.
NE PAS utiliser pour ranger des vêtements.
Improper use may cause furniture tipover.
Une utilisation incorrecte peut entraîner le basculement des meubles.

Important - Please read these instructions fully before starting assembly
Important - Veuillez lire attentivement ces instructions avant de commencer l'assemblage.



Safety and Care Advice

Important – Please read these instructions fully before starting assembly

- Check you have all the components and tools listed on the following pages.
- Remove all fittings from the plastic bags and separate them into their groups.
- Keep children and animals away from the work area, small parts could choke if swallowed.
- Make sure you have enough space to layout the parts before starting.

- During assembly do not stand or put weight on the product, this could cause damage.
- Assemble the item as close to its final position (in the same room) as possible.
- Assemble on a soft level surface to avoid damaging the unit or your floor.
- Parts of the assembly will be easier with 2 people.



power drill is set on a low torque setting.

- To reduce the likelihood of damaging your product please ensure that your

Care and maintenance

- Only clean using a damp cloth and mild detergent, do not use bleach or abrasive cleaners.
- From time to time check that there are no loose screws on this unit.
- This product should not be discarded with household waste. Take to your local authority waste disposal centre.

Handy Hints

- Assemble all parts and bolts loosely during assembly, only once the product is complete should you fully tighten the bolts
- Regularly check and ensure That all bolts and fittings are tightened properly.

WARNING
In order to help prevent overturning – please follow these instructions

To help prevent product toppling over please follow the below steps:-

- Use the anti tip stap or wall fixing method provided (if applicable)
- Do not allow children to climb or hang on the furniture
- Do not open more than one drawer at a time
- Do not place heavy items in the top drawers
- Do not place heavy items on top of the furniture, unless the furniture has been designed for this purpose

A



Cam bolt /Boulon à came
46+1(Pcs)

B

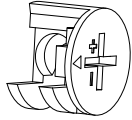

Cam lock/Verrou à came
46+1(Pcs)

C



Dowel/Goujon
36+3(Pcs)

D

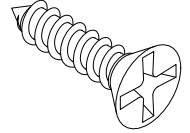

Ø3.5x15(mm)Screws/vis
24+2(Pcs)

E

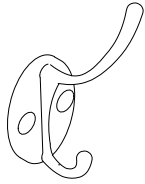

Cloth hook/Crochet à tissu
4(Pcs)

F

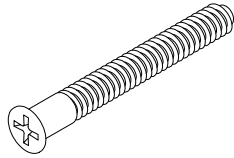

Confimart screws/Vis Confimart
14(Pcs)

G

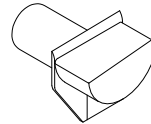

Moveable partition/Cloison mobile
6(Pcs)

I

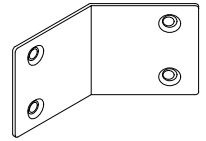

Steel connection/Assemblage en
acier
4(Pcs)

H

Anti-tipping/ Dispositif anti-basculement

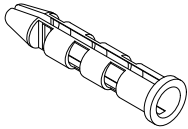

(H1)
2(Pcs)

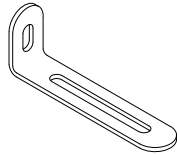

(H2)
2(Pcs)

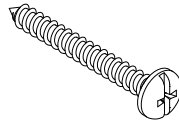

(H3)
2(Pcs)

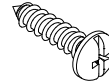

(H4)
2+2(Pcs)

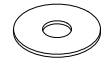

(H5)
4(Pcs)

J

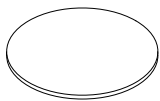

Sticker cover
Couverture autocollante
10+3(Pcs)

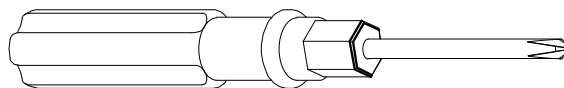

ASSEMBLY TOOLS REQUIRED (NOT INCLUDED)

PLEASE BE CAREFUL DO NOT DAMAGE THE HOLE POSITION
WHEN YOU USE POWER TOOLS !

ATTENTION À NE PAS ENDOMMAGER LA POSITION DU TROU
LORSQUE VOUS UTILISEZ DES OUTILS ÉLECTRIQUES !

Using Camlocks

Step 1

Connect the male camlock as directed in the assembly instructions using a screwdriver.

1

DO NOT OVER TIGHTEN.
NE PAS SERRER EXCESSIVEMENT.

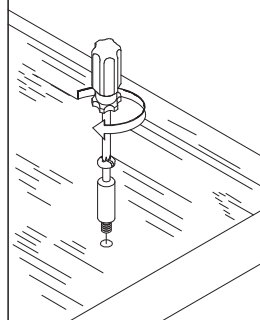

Step 2

Push the male camlock into the entry hole.

2

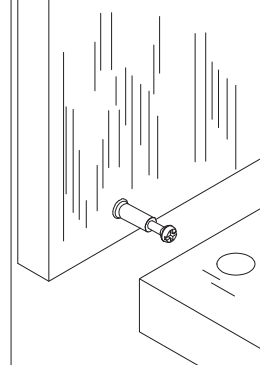

Step 3

Insert the female camlock as shown in the instruction.

Note: ensure that the arrow on the top of the camlock points towards the entry hole for the male camlock.

3

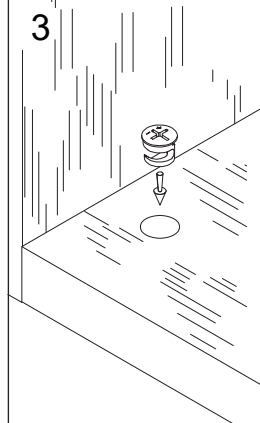

Step 4

Turn the female camlock clockwise with a screwdriver.

You should feel a click when the camlock is locked in place.

The joint is now secure.

4

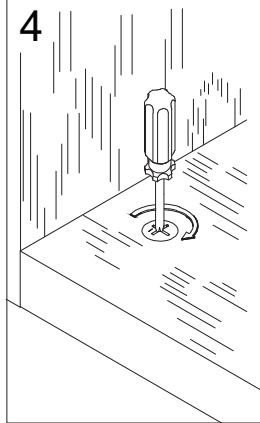

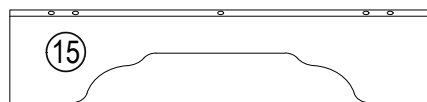
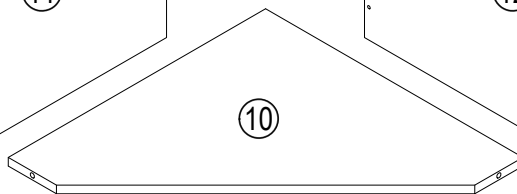
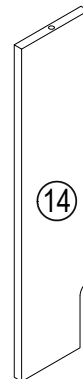
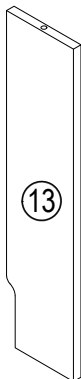
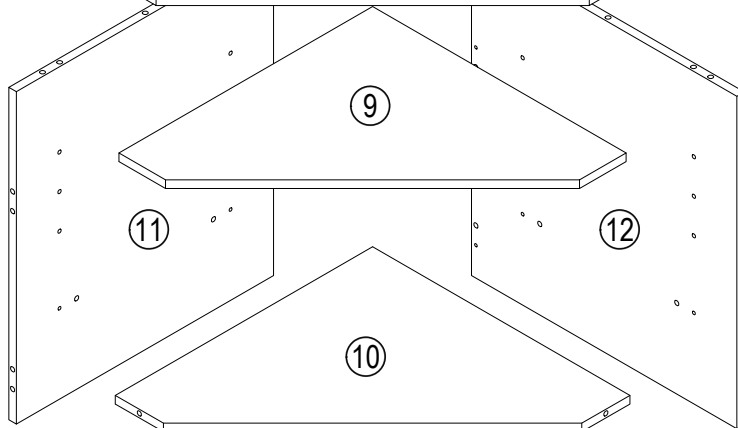
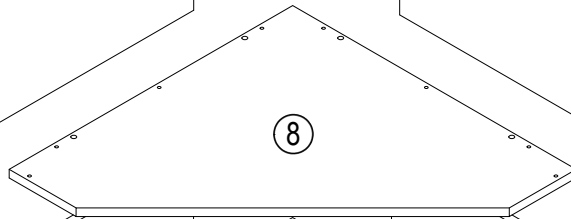
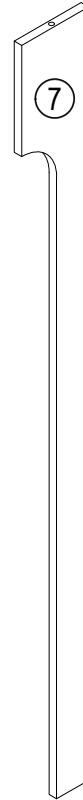
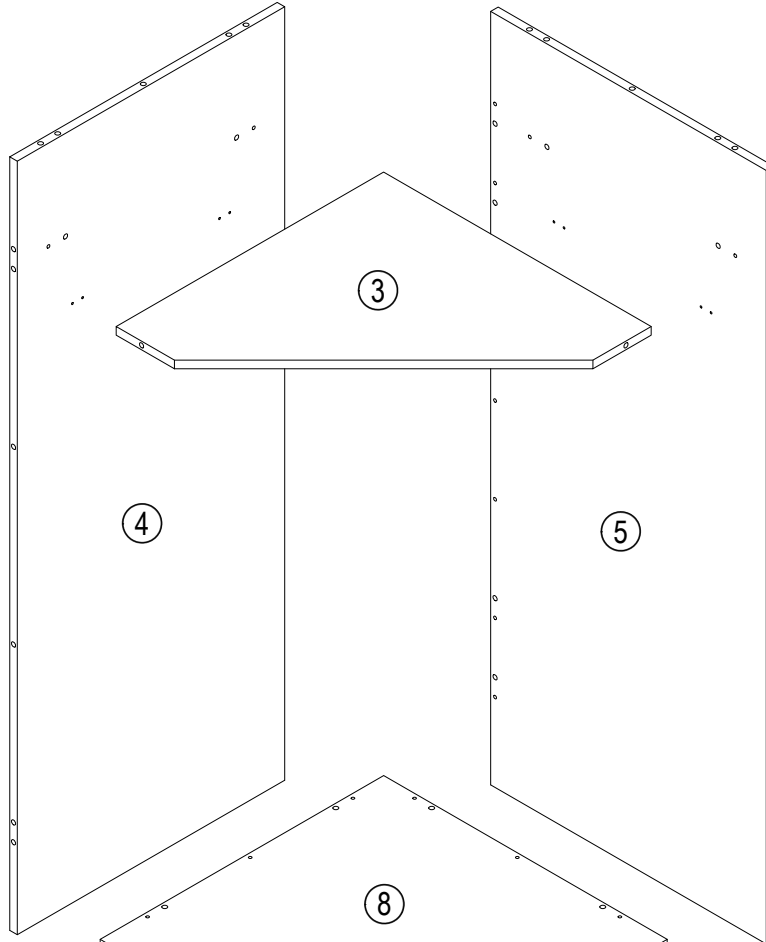
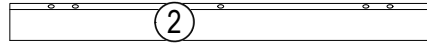
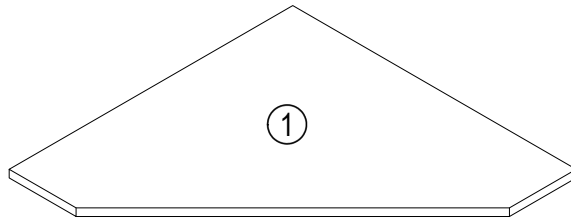

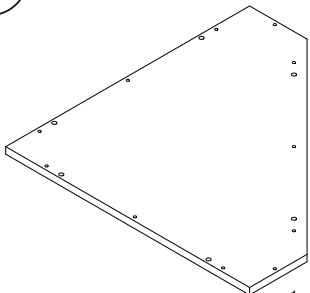
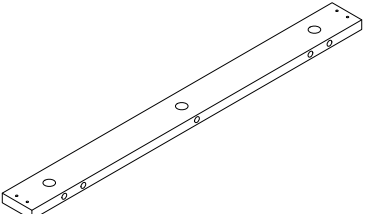
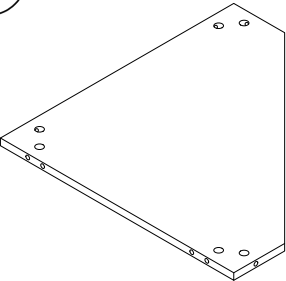
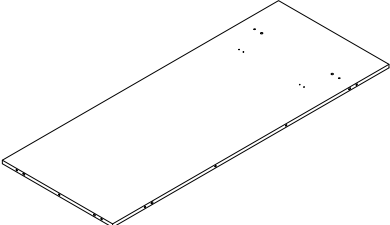
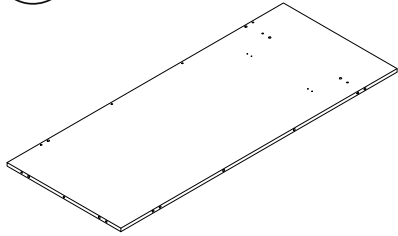
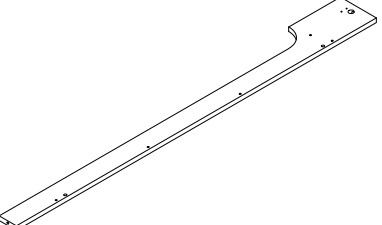
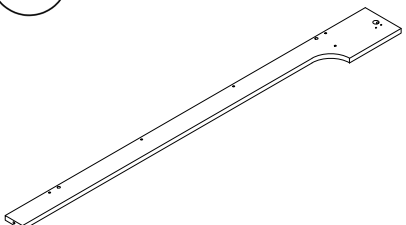
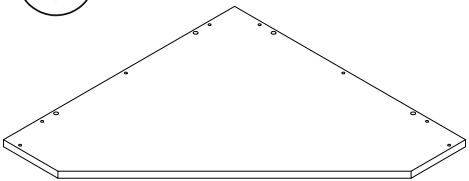
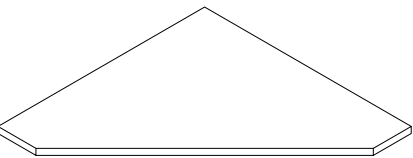
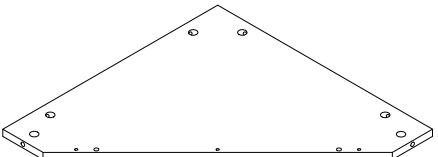
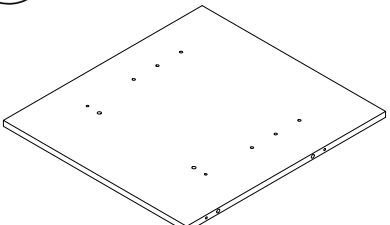
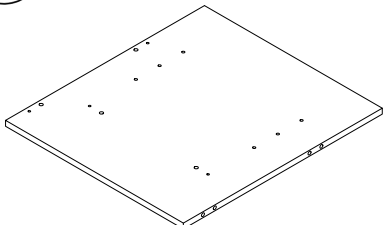
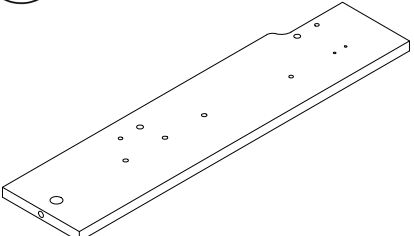
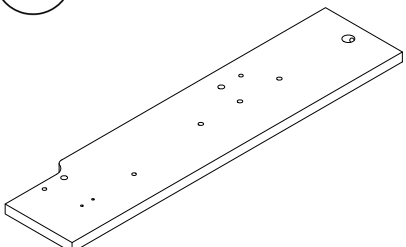
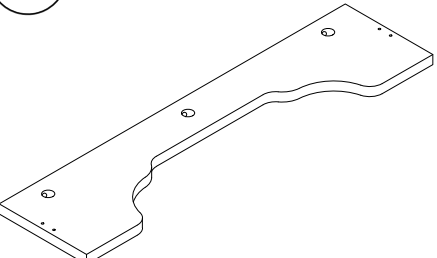

<p>1 530x530x14(mm)</p>  <p>1 (Pcs)</p>	<p>2 557x50x14(mm)</p>  <p>1 (Pcs)</p>	<p>3 500x500x14(mm)</p>  <p>1 (Pcs)</p>
<p>4 1252x500x14(mm)</p>  <p>1 (Pcs)</p>	<p>5 1252x515x14(mm)</p>  <p>1 (Pcs)</p>	<p>6 1252x125x14(mm)</p>  <p>1 (Pcs)</p>
<p>7 1252x125x14(mm)</p>  <p>1 (Pcs)</p>	<p>8 530x530x14(mm)</p>  <p>1 (Pcs)</p>	<p>9 480x480x14(mm)</p>  <p>1 (Pcs)</p>
<p>10 481x481x14(mm)</p>  <p>1 (Pcs)</p>	<p>11 538x481x14(mm)</p>  <p>1 (Pcs)</p>	<p>12 538x496x14(mm)</p>  <p>1 (Pcs)</p>
<p>13 538x125x14(mm)</p>  <p>1 (Pcs)</p>	<p>14 538x125x14(mm)</p>  <p>1 (Pcs)</p>	<p>15 557x140x14(mm)</p>  <p>1 (Pcs)</p>

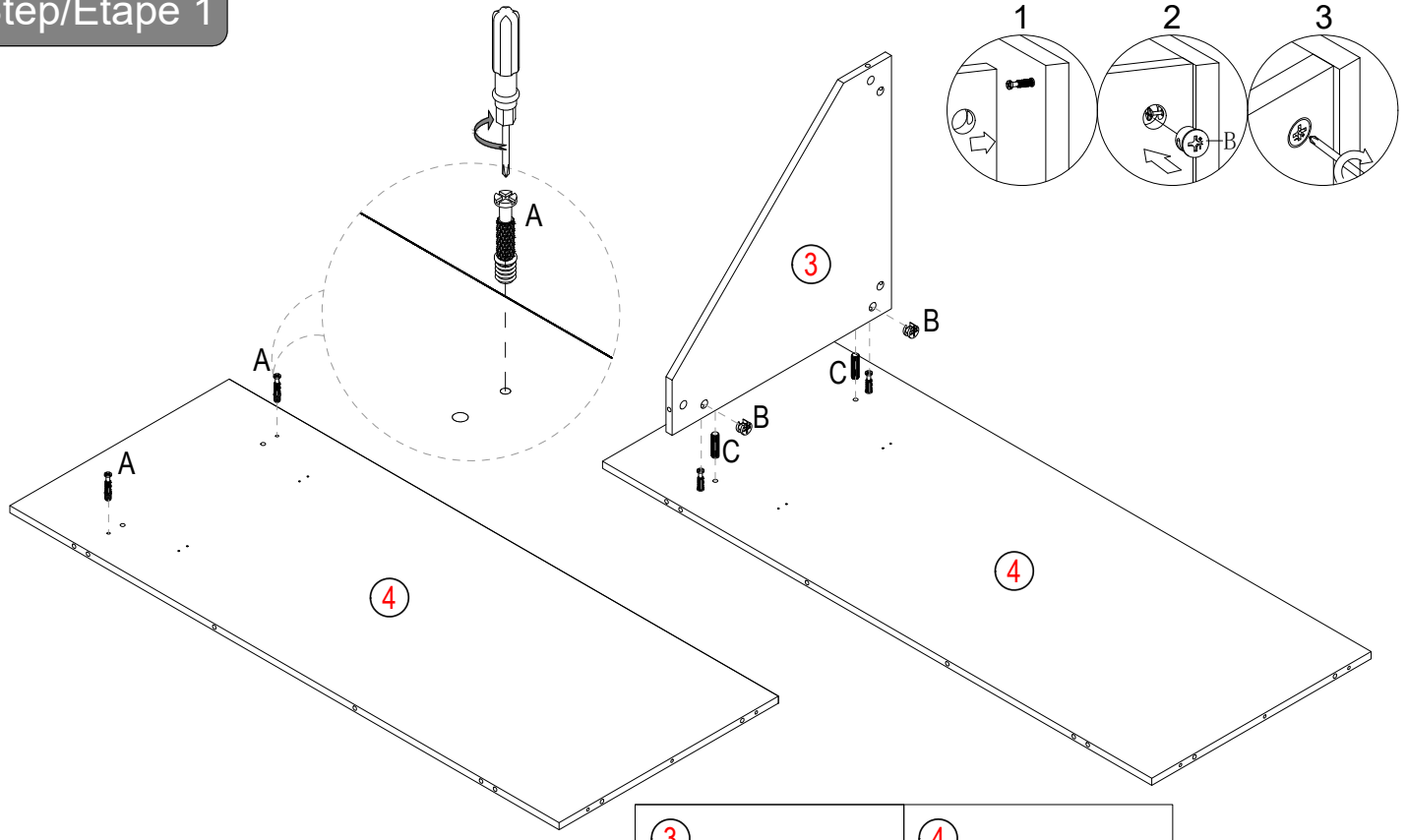
Step/Étape 1



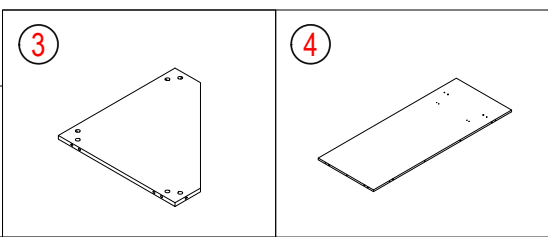

- (A)**  Cam Bolt (x2)
- (B)**  Cam Lock (x2)
- (C)**  Dowel (x2)

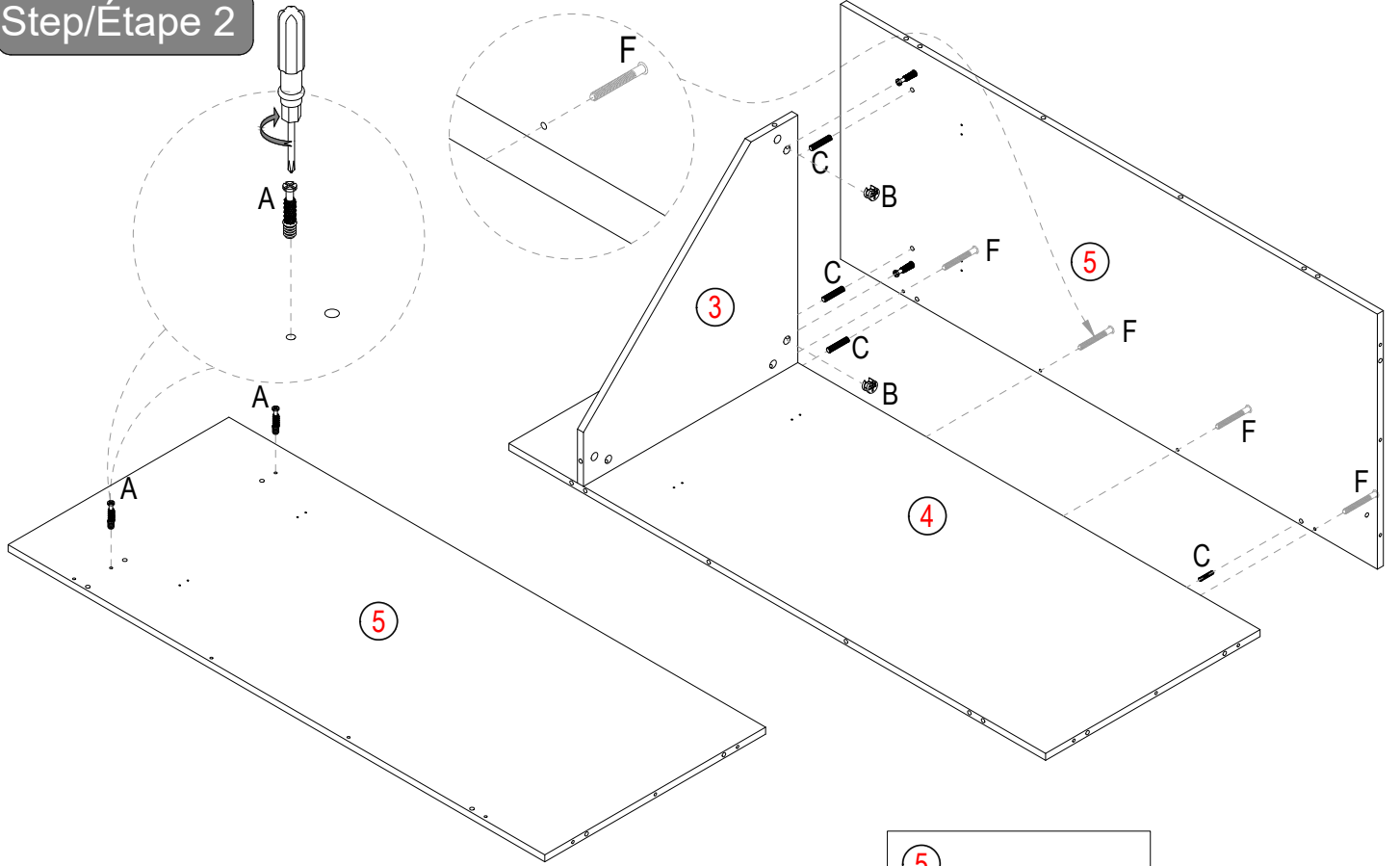

Step/Étape 2



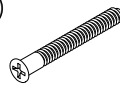

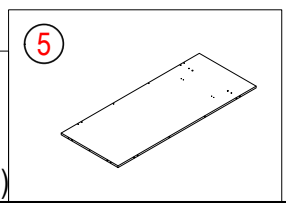
- (A)**  Cam Bolt (x2)
- (B)**  Cam Lock (x2)
- (C)**  Dowel (x4)
- (F)**  Confimat Screw(x4)



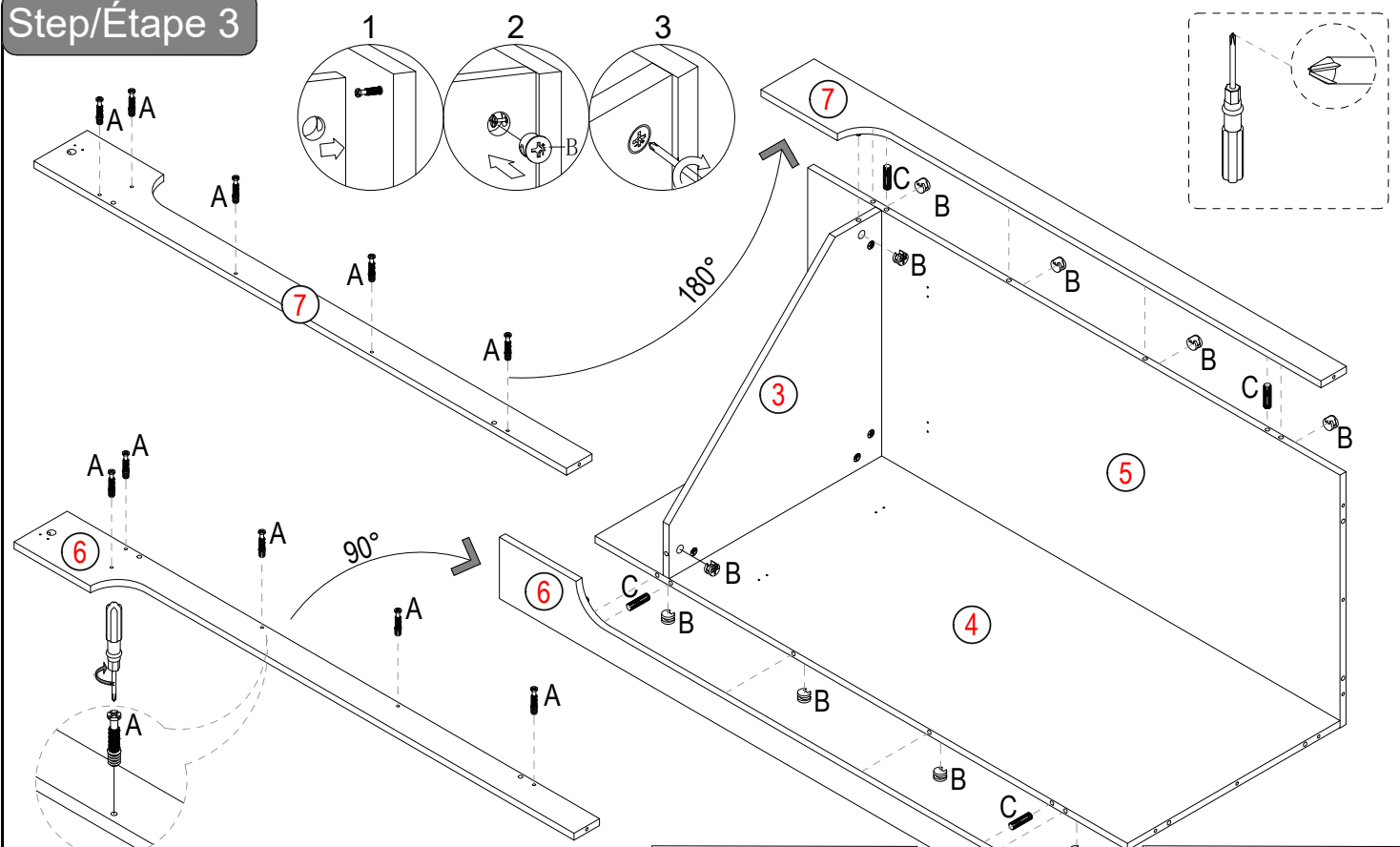



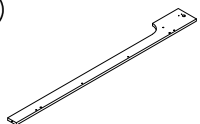
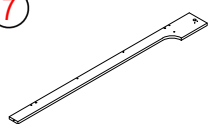

Step/Étape 3

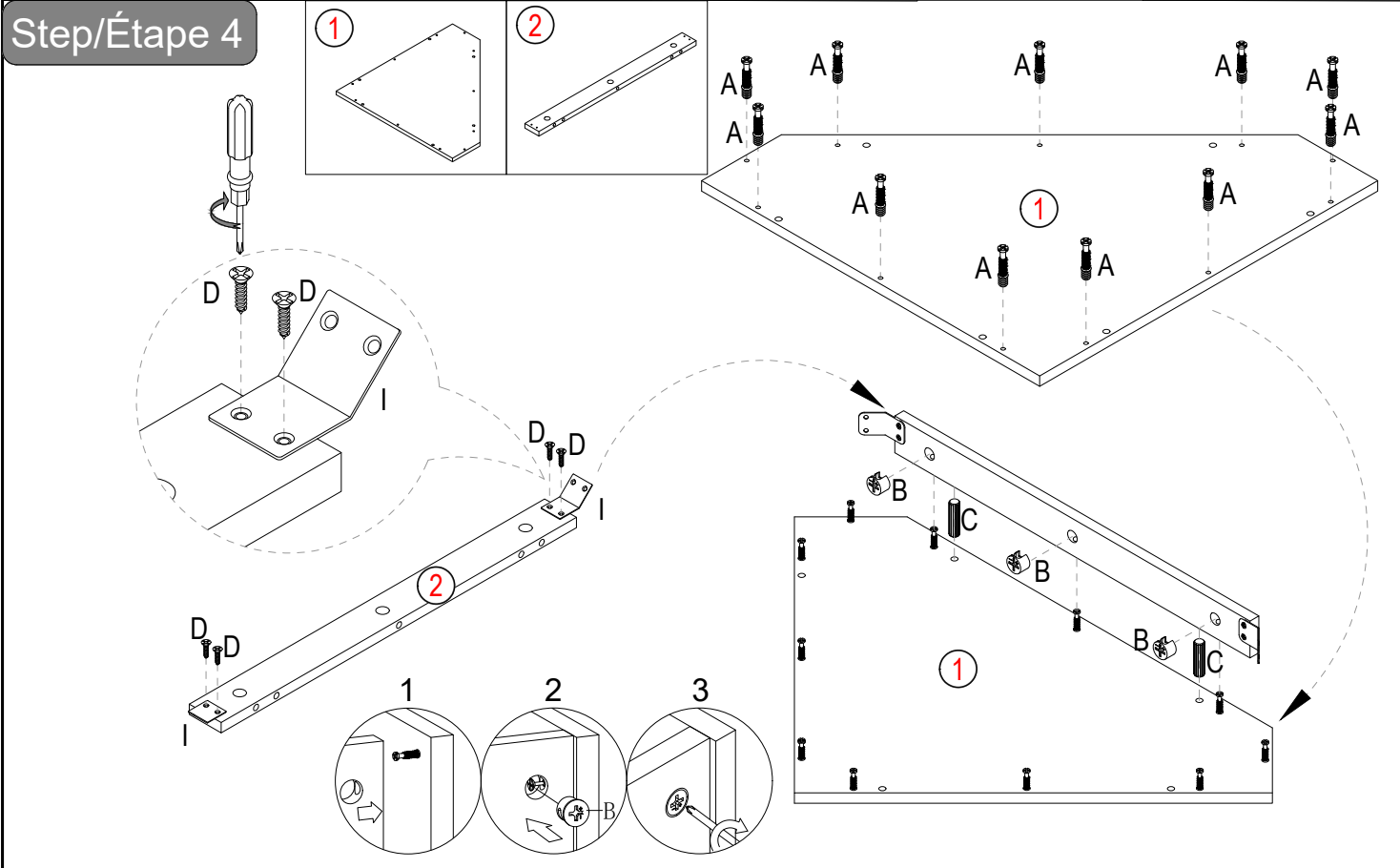

- | | | | | |
|---|---|---|---|--|
| <p>(A)</p>  <p>Cam Bolt (x10)</p> | <p>(B)</p>  <p>Cam Lock (x10)</p> | <p>(C)</p>  <p>Dowel (x4)</p> | <p>(6)</p>  | <p>(7)</p>  |
|---|---|---|---|--|

Step/Étape 4

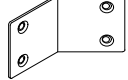

- | | | | | |
|---|--|---|---|--|
| <p>(A)</p>  <p>Cam Bolt (x11)</p> | <p>(B)</p>  <p>Cam Lock (x3)</p> | <p>(C)</p>  <p>Dowel (x2)</p> | <p>(I)</p>  <p>Connection(x2)</p> | <p>(D)</p>  <p>3.5x15 (x4)</p> |
|---|--|---|---|--|

Step/Étape 5

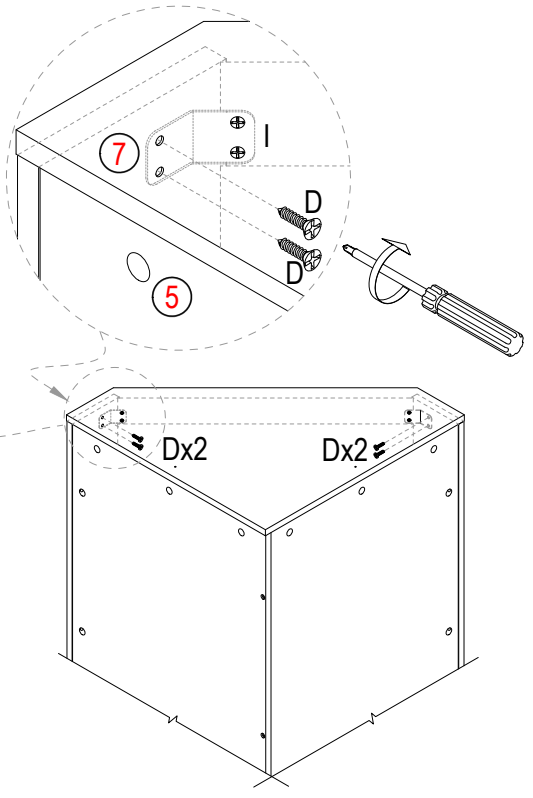
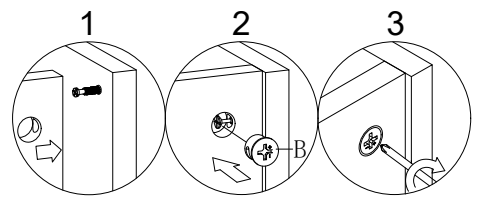
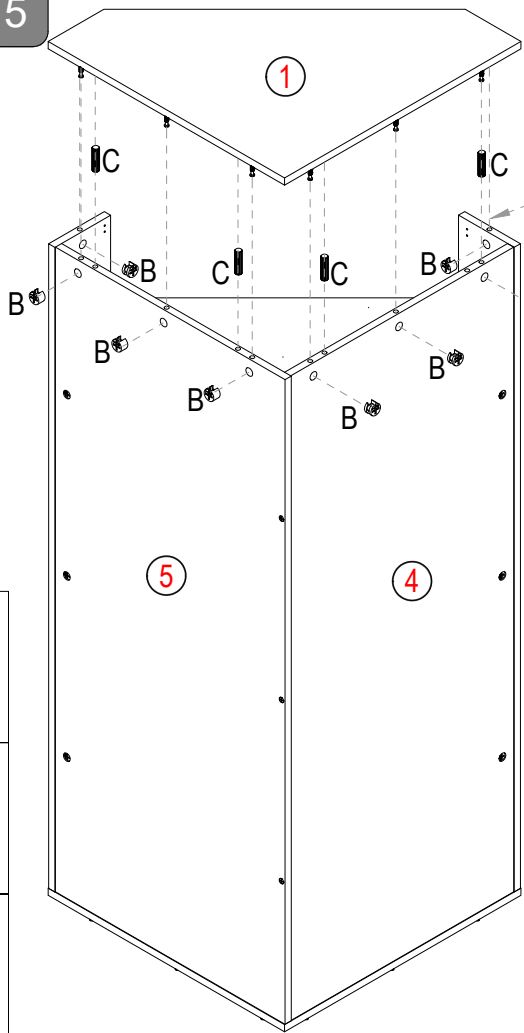

- (B) Cam Lock (x8)
- (C) Dowel (x4)
- (D) 3.5x15 (x4)

Step/Étape 6

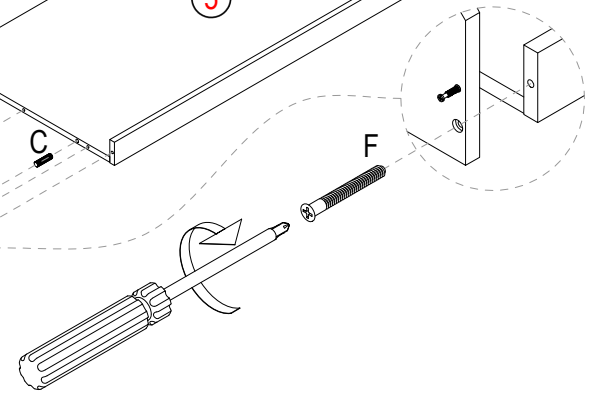
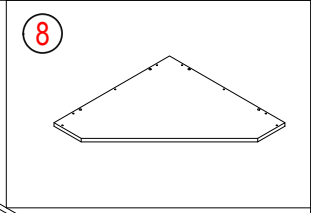
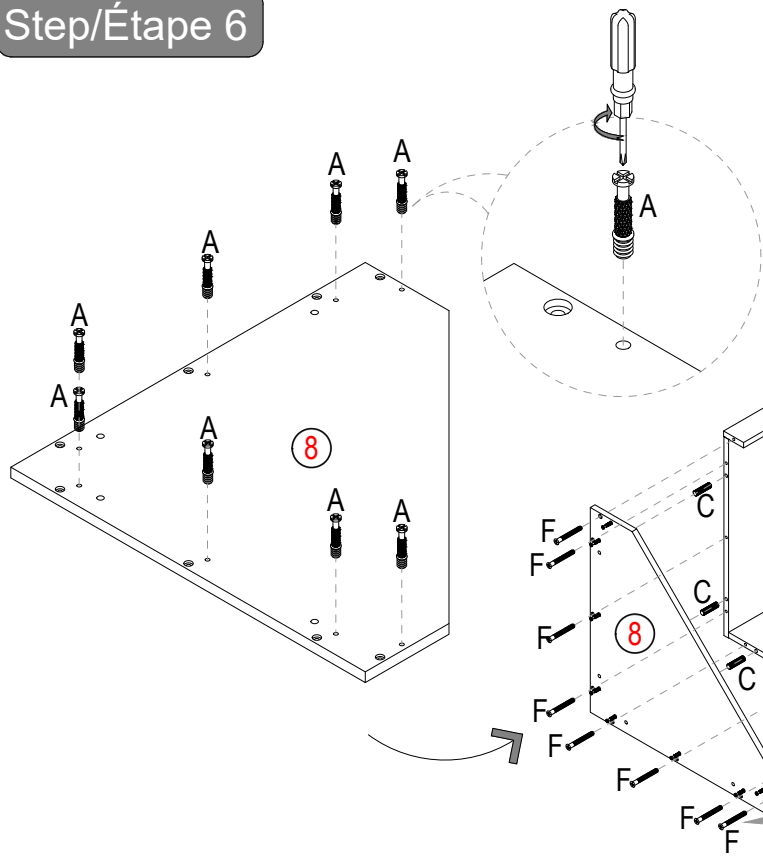

- (A) Cam Bolt (x8)
- (C) Dowel (x4)
- (F) Conformat Screw(x8)

Step/Étape 7

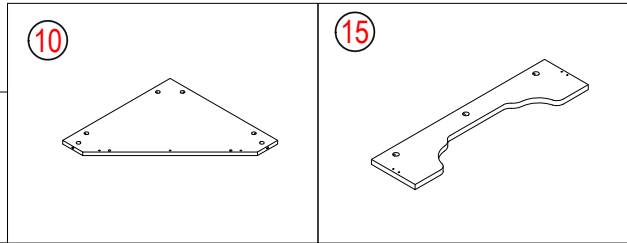
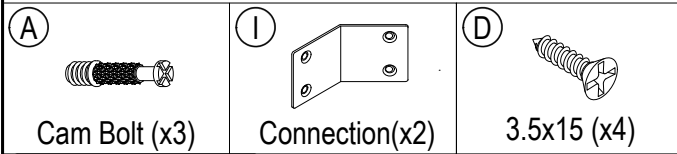
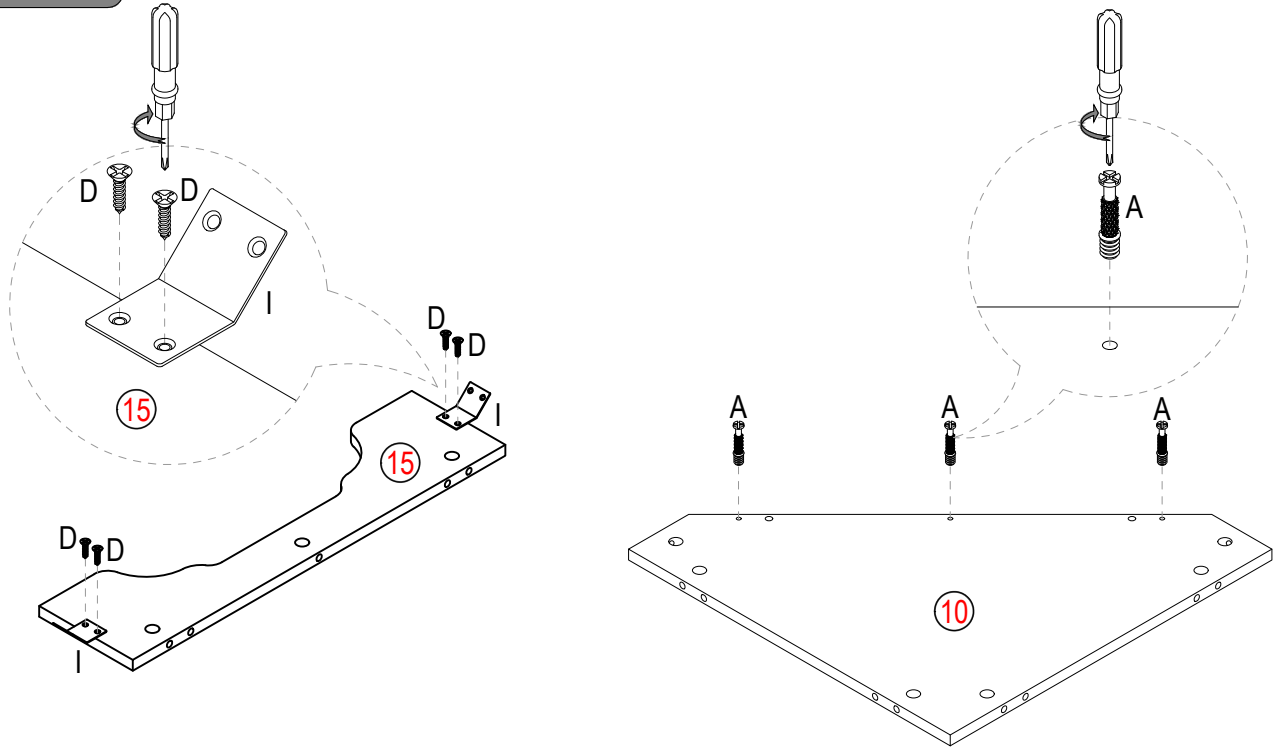

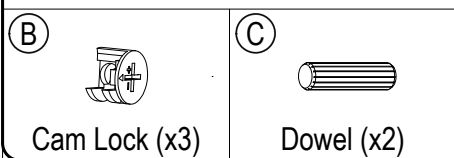
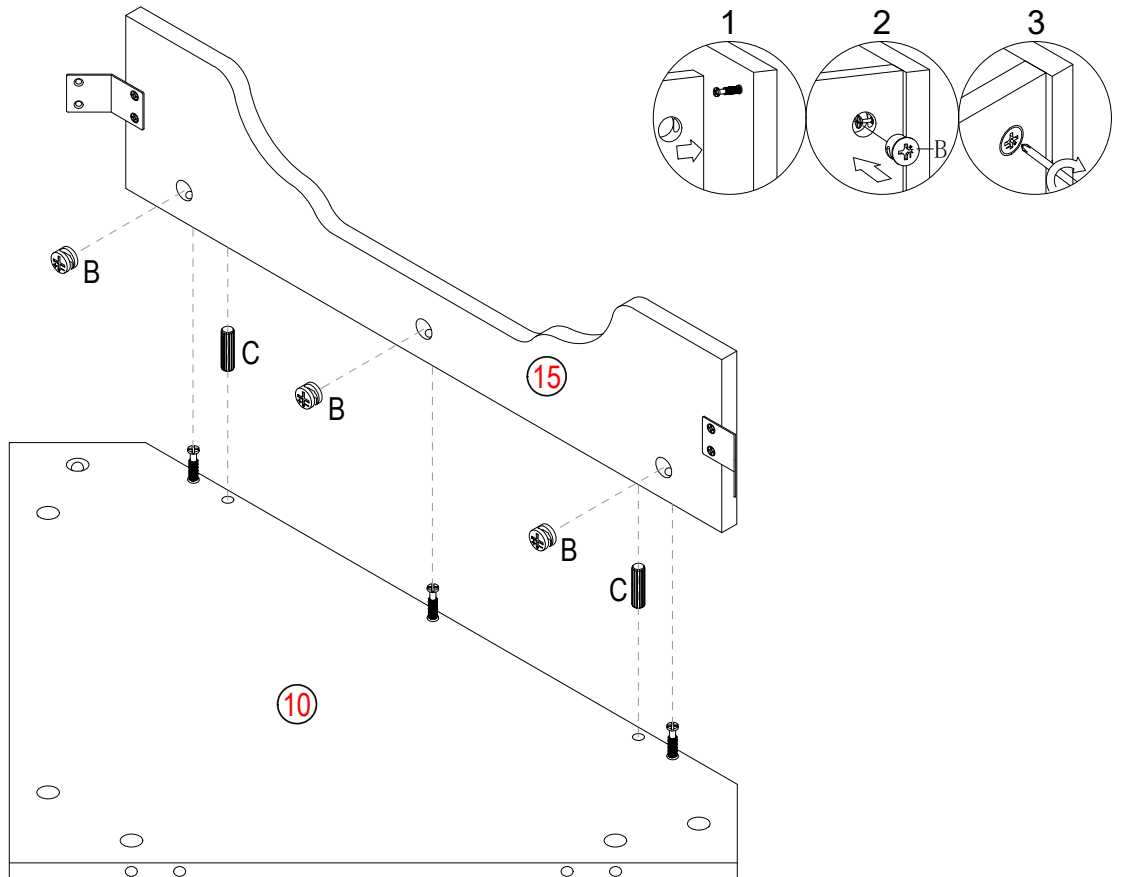

Step/Étape 8

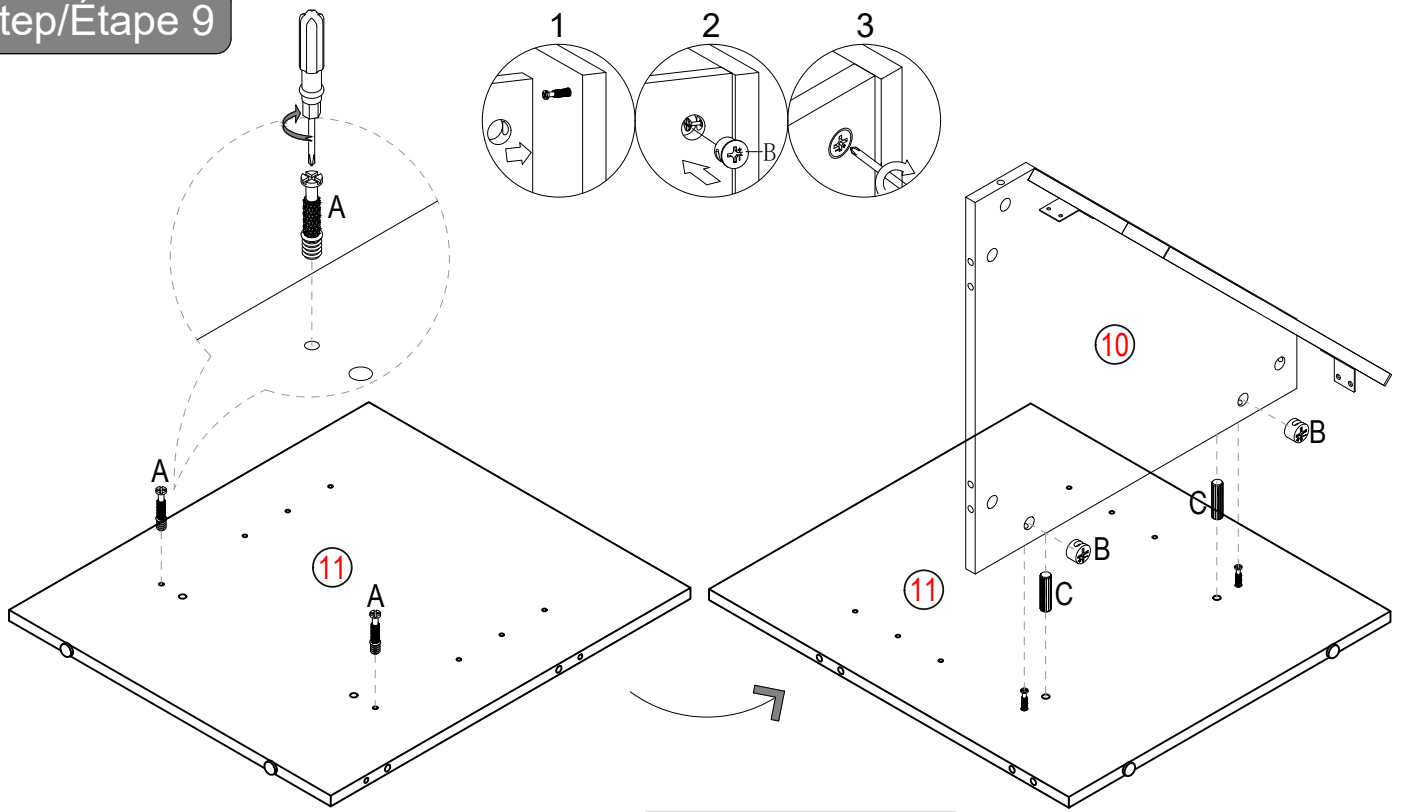

Step/Étape 9





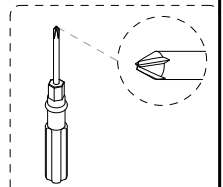
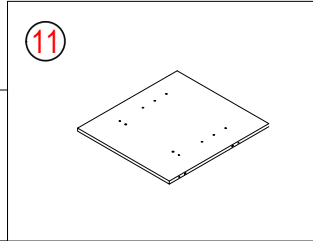

- | | | |
|--|---|---|
| <p>(A)</p>  <p>Cam Bolt (x2)</p> | <p>(B)</p>  <p>Cam Lock (x2)</p> | <p>(C)</p>  <p>Dowel (x2)</p> |
|--|---|---|

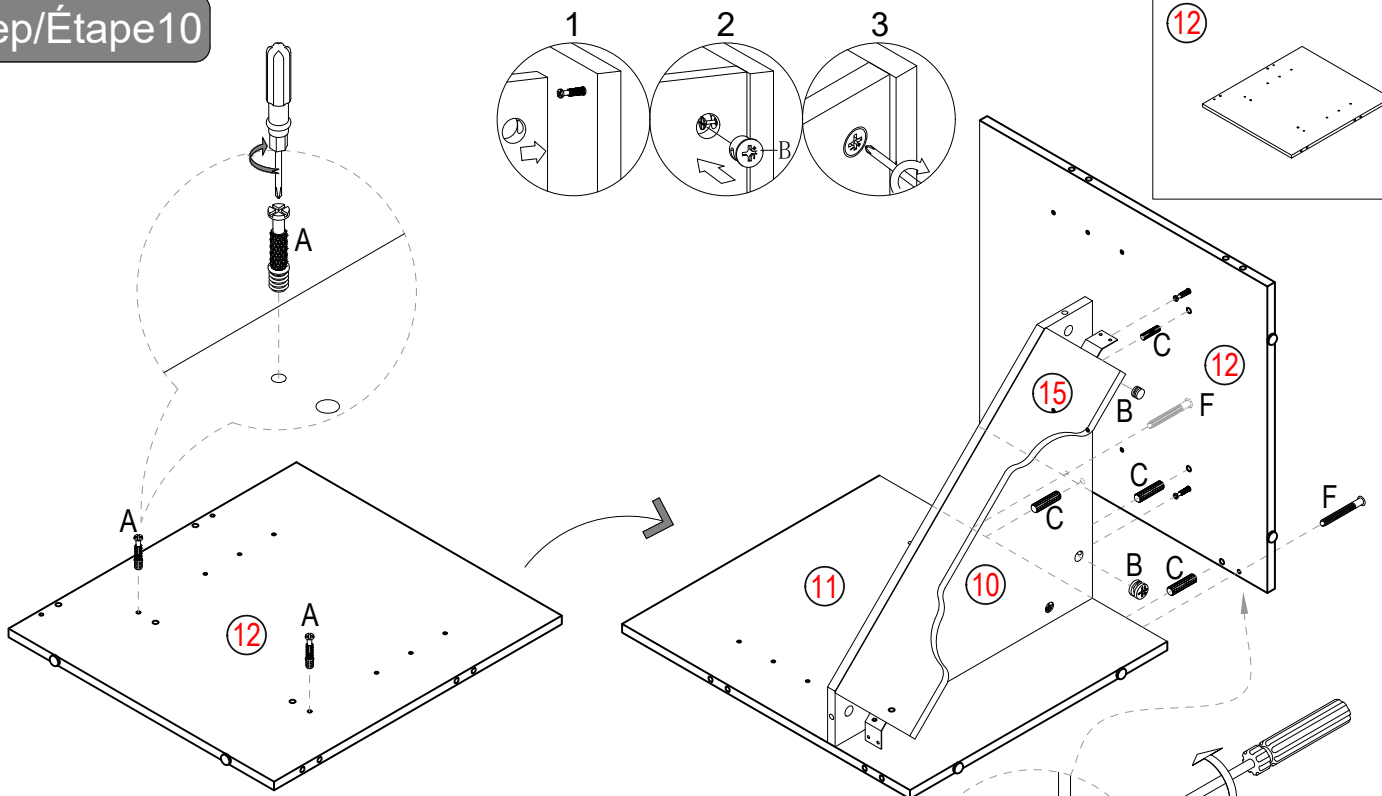

Step/Étape 10



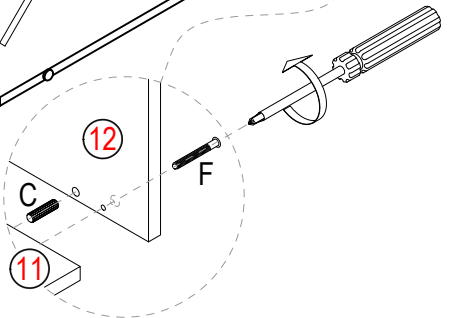

- | | | | |
|--|--|---|---|
| <p>(A)</p>  <p>Cam Bolt (x2)</p> | <p>(B)</p>  <p>Cam Lock (x2)</p> | <p>(C)</p>  <p>Dowel (x4)</p> | <p>(F)</p>  <p>Confimat Screw(x2)</p> |
|--|--|---|---|



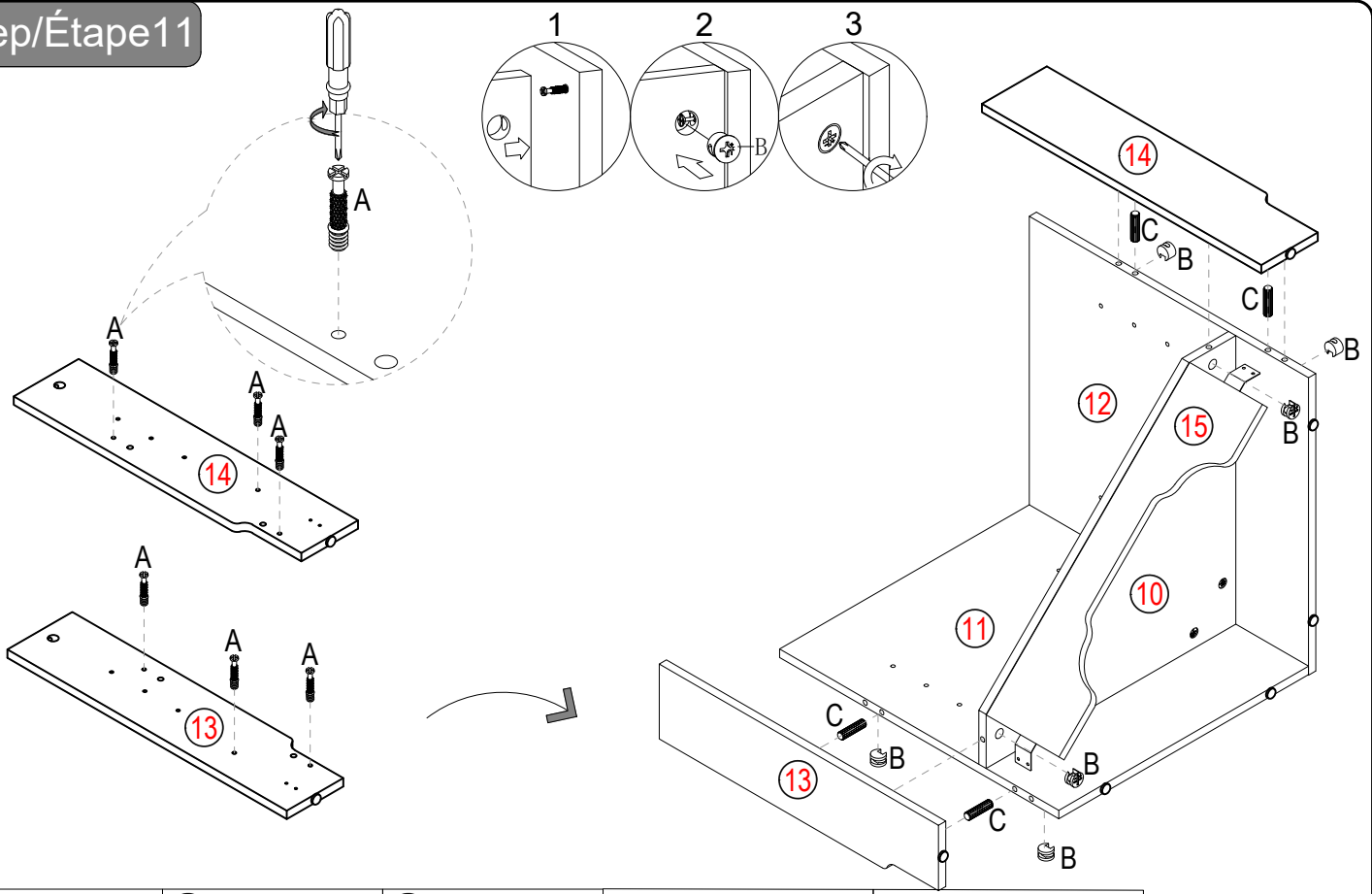

Step/Étape 11

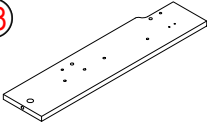
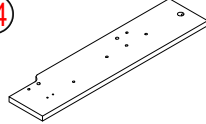

- | | | | | |
|---|--|--|--|--|
| <p>(A) </p> <p>Cam Bolt (x6)</p> | <p>(B) </p> <p>Cam Lock (x6)</p> | <p>(C) </p> <p>Dowel (x4)</p> | <p>(13) </p> | <p>(14) </p> |
|---|--|--|--|--|

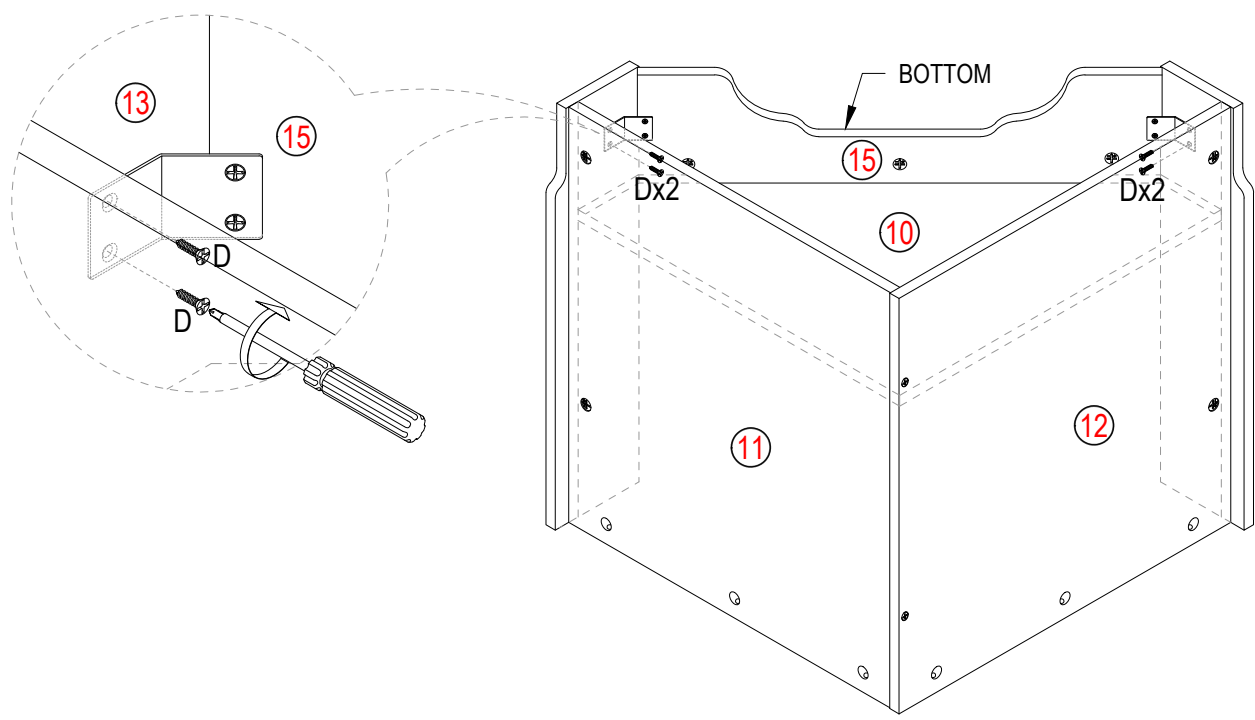
Step/Étape 12





- | |
|---|
| <p>(D) </p> <p>3.5x15 (x4)</p> |
|---|

Step/Étape 13

180°

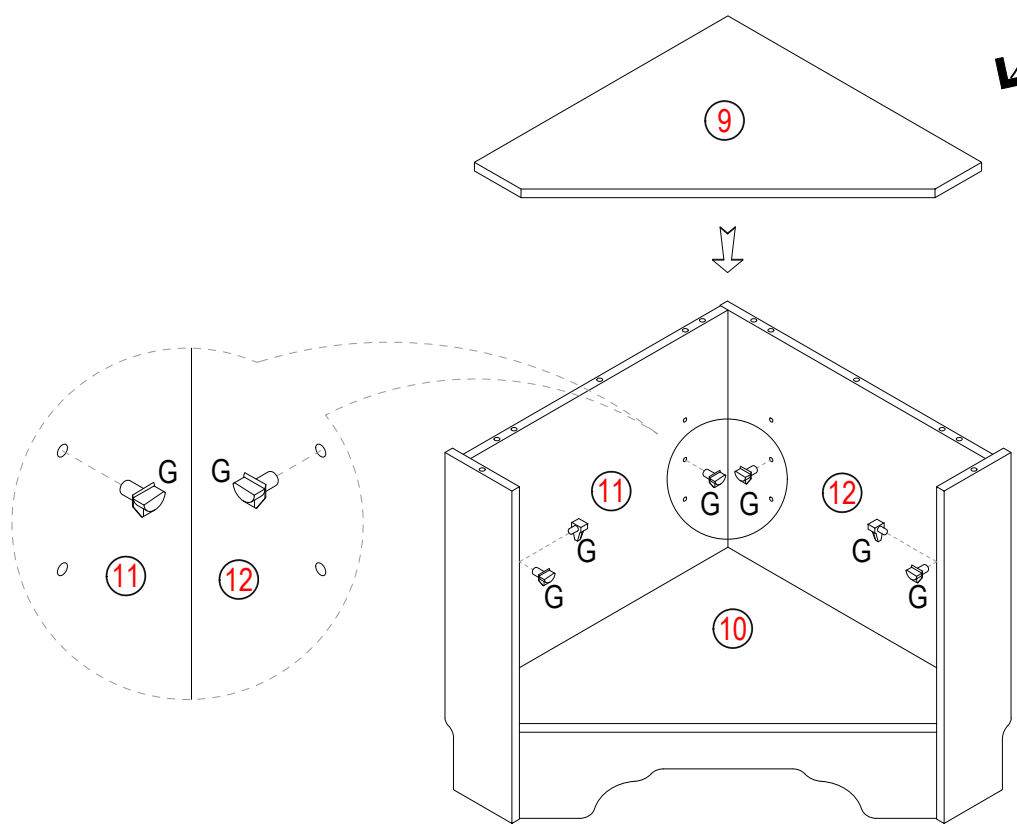
Be careful!
At least two
people are
required.



(G) 
Moveable partition
Bracket (x6)

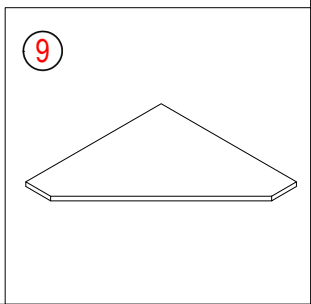

Step/Étape 14

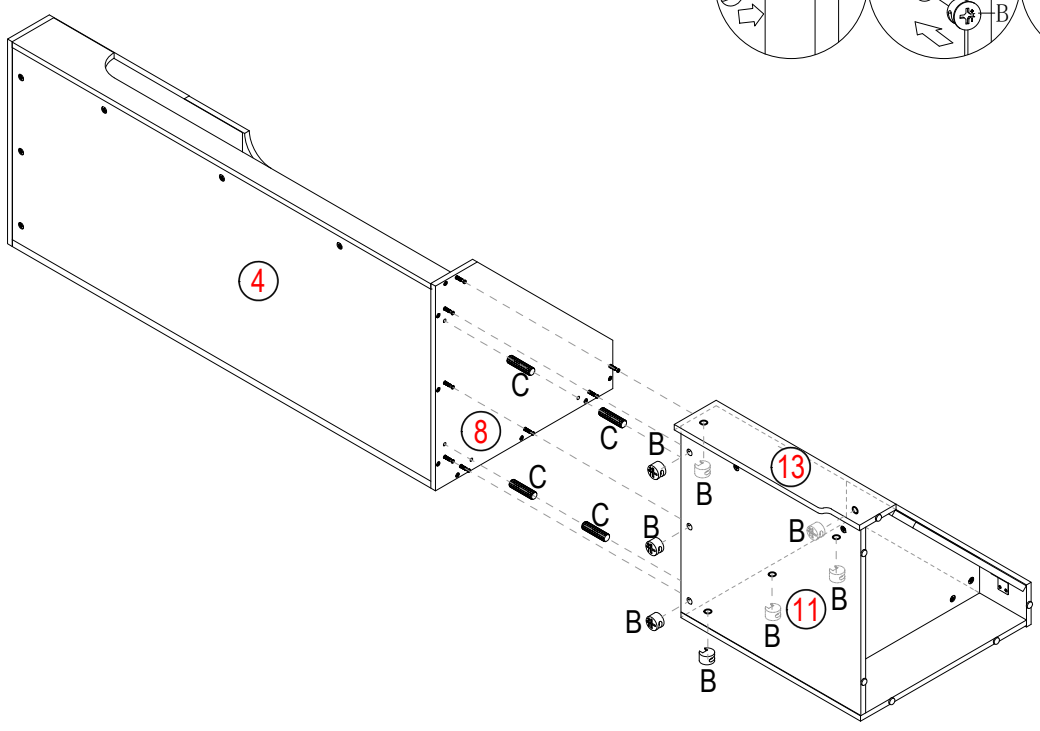
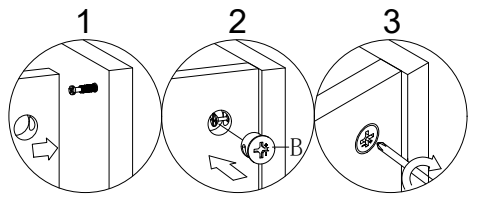

(B) 
Cam Lock (x8)

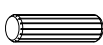
(C) 
Dowel (x4)







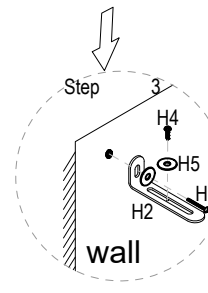
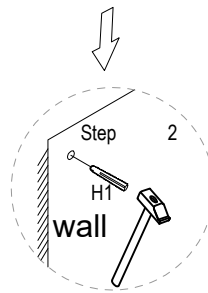
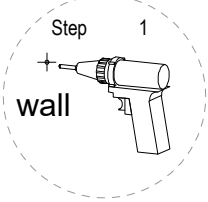
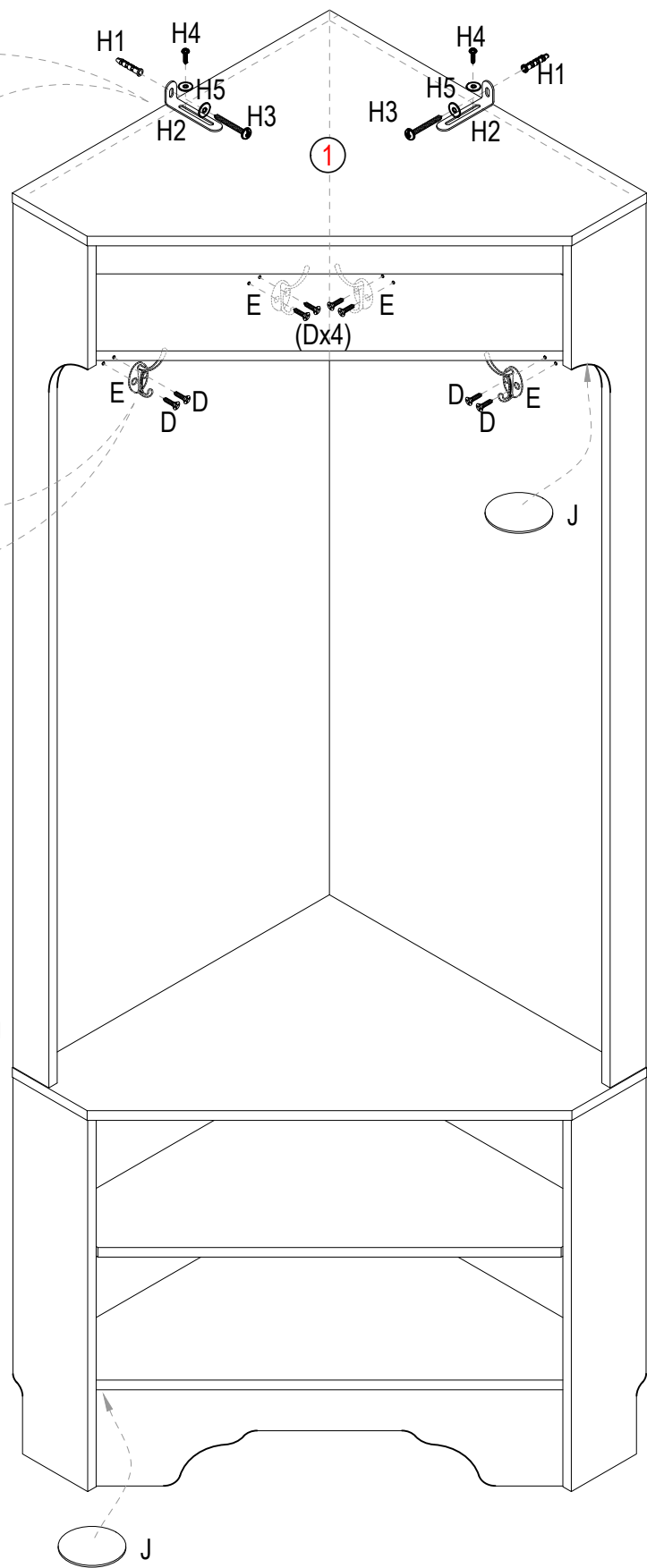
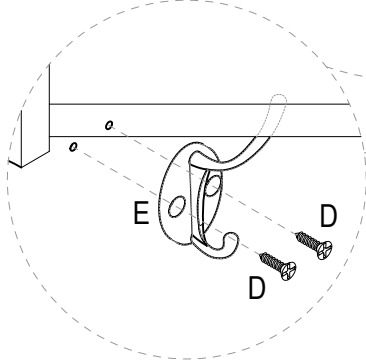
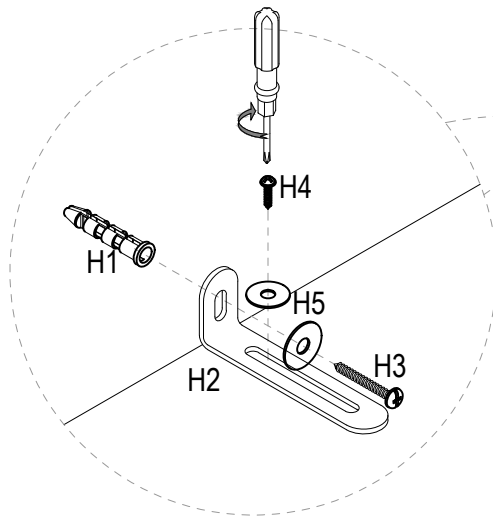

Step/Étape 15

Be careful! At least two people are required.

90°



J can be utilized as a shielding component for the exposed holes, enhancing the overall aesthetic of the product.
 J peut être utilisé comme élément de protection pour les trous apparents, améliorant ainsi l'esthétique générale du produit."

<p>(E) </p> <p>Cloth hook (x4)</p>	<p>(D) </p> <p>3.5x15 (x8)</p>	<p>(H) Anti-tipping</p> <p>    </p> <p>H1(x2) H2(x2) H3(x2) H4(x2) H5(x4)</p>	<p>(J) </p> <p>Sticker cover(x10)</p>
---	---	--	--

Finish/Finition

