

ASSEMBLY INSTRUCTION
TWIN LOFT AND FULL BED
WF284149 /WF284150/WF280151



! SAFETY WARNINGS !

1. This bed is designed for use only mattress(es) meeting the following specifications on the upper bunk, and lower bunk:

LOFT BED

Bed Type	Length	Width	Thickness
Twin standard	74" - 75"	38 1/2"	6" max

FULL BED







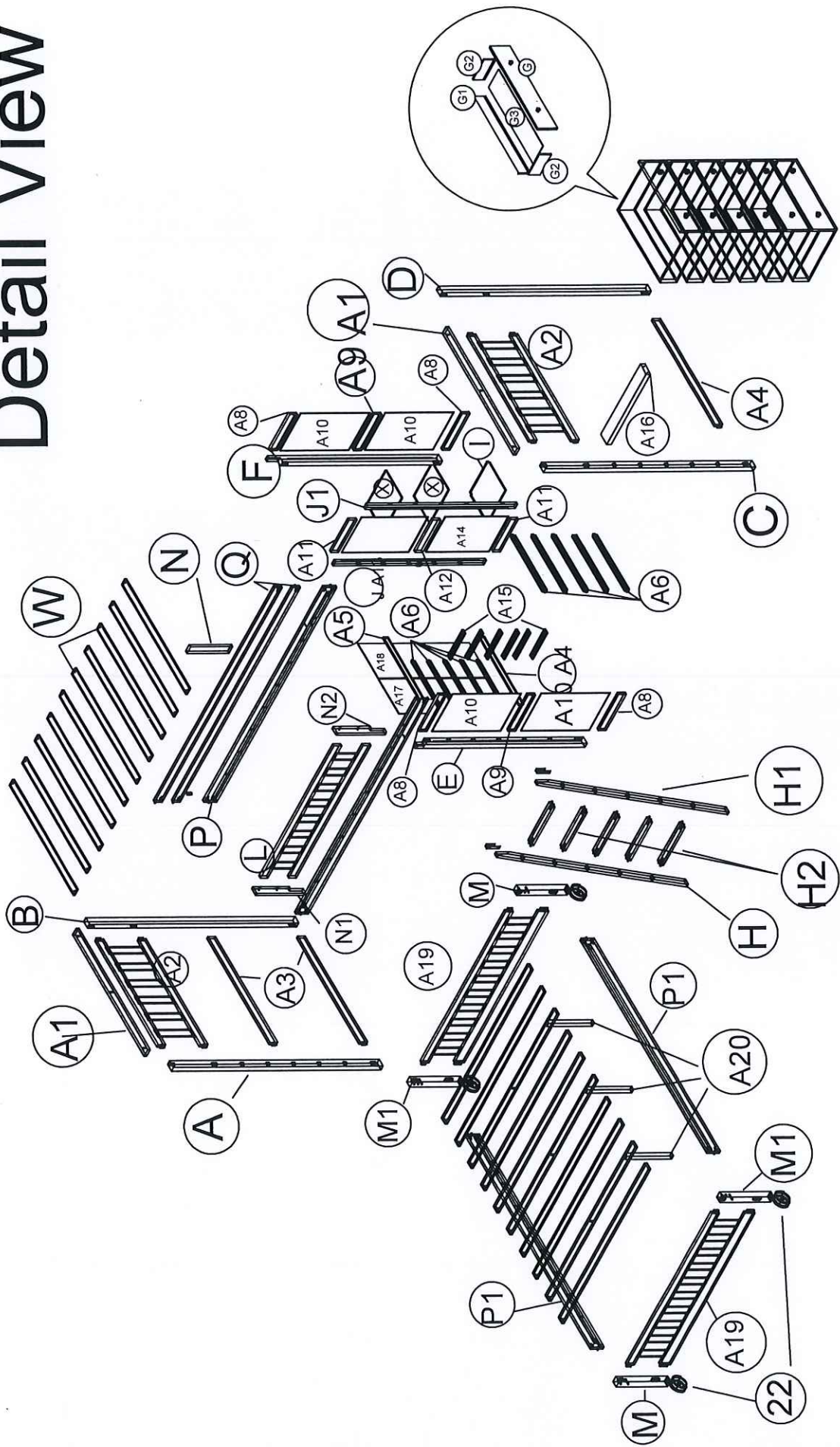









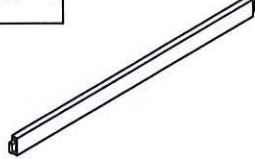
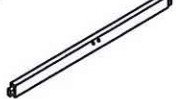

Bed Type	Length	Width	Thickness
Full standard	74" - 75"	53" - 54"	6" max

2. Replacement parts, including additional guardrails, may be obtained from any of our (GIGACLOUD TECHNOLOGY(USA)INC) dealers
3. Follow the information on the warnings appearing on the upper bunk bed end structure and on the carton.
Do not remove warning label from bed.
4. Always use the recommended size mattresses or mattress supports, or both, to help prevent the likelihood of entrapment or falls.
5. Surface of the mattress must be at least 5 in. (127 mm) below the upper edge of guardrails.
6. Do not allow children under 6 years of age to use the upper bunk.
7. Periodically check and ensure that the guardrail, ladder, and other components are in their proper position, free from damage, and that all connectors are tight.
8. Do not allow horseplay on or under the bed and prohibit jumping on the bed
9. Always use the ladder for entering and leaving the upper bunk.
10. Do not use substitute parts. Contact the manufacturer or dealer for replacement parts.
11. Use of a night light may provided added safety precaution for a child using the upper bunk.
12. Always use guardrails on both long sides of the upper bunk. If the bunk bed will be placed next to the wall, the guardrail that runs the full length of the bed should be placed against the wall to prevent entrapment between the bed and wall.
13. The use of water or sleep flotation mattresses is prohibited.
14. STRANGULATION HAZARO -Never attach or hang items to any part of the bunk bed that are not designed for ued with the bed ,for example ,but not limited to,hook,belts and jump ropes
15. Keep these instructions for future reference
16. Prohibit morethan one person on upper bunk .
17. We recommend assembling your bunk bed on the shipping carton to protect your floor or carpet.
18. Be certain all staples are out of the box before beginning assembly on the shipping carton.

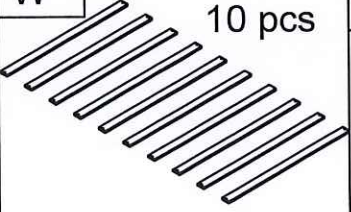







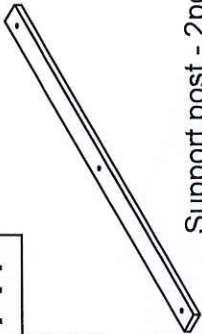

Detail View

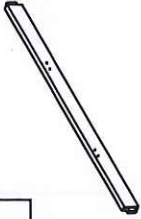

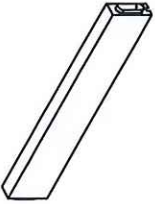

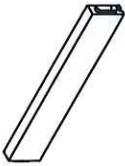

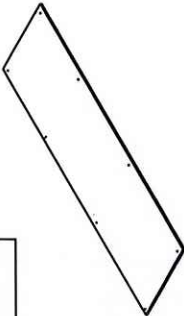

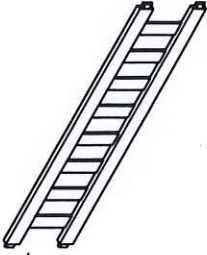
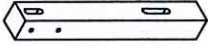
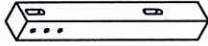
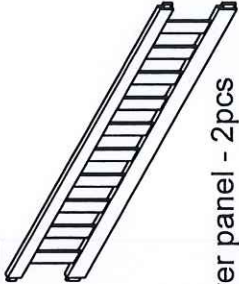
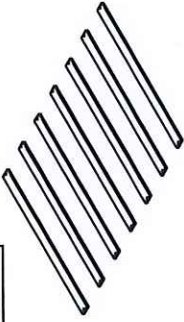

WF 284149 TWIN LOFT AND FULL BED

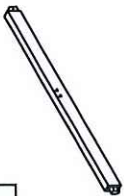
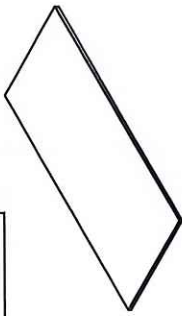
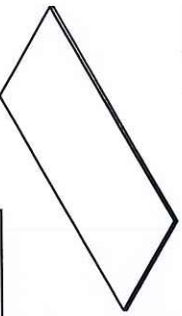
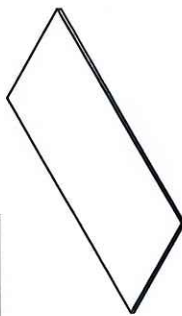
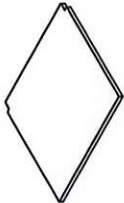
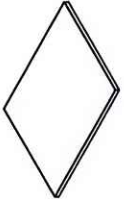
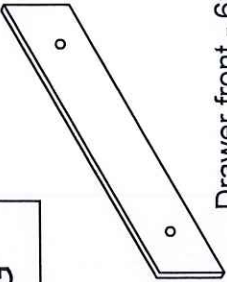
<p>A</p>  <p>Leg - 1 pcs</p>	<p>B</p>  <p>Leg - 1 pcs</p>	<p>C</p>  <p>Leg - 1 pcs</p>	<p>D</p>  <p>Leg - 1 pcs</p>
<p>E</p>  <p>Leg - 1 pcs</p>	<p>F</p>  <p>Leg - 1 pcs</p>	<p>A3</p>  <p>Horizontal bar - 2 pcs</p>	<p>A6</p>  <p>Horizontal bar - 6 pcs</p>
<p>J</p>  <p>Leg - 1 pcs</p>	<p>A15</p>  <p>Horizontal bar - 6 pcs</p>	<p>A16</p>  <p>Horizontal bar - 1 pcs</p>	<p>K</p>  <p>Side rail - 1 pcs</p>
<p>P</p>  <p>Side rail - 1 pcs</p>	<p>W</p>  <p>10 pcs</p>	<p>H</p>  <p>Leg - 1 pcs</p>	<p>H1</p>  <p>Leg - 1 pcs</p>
<p>H2</p>  <p>Horizontal bar - 5 pcs</p>	<p>P1</p>  <p>Side rail - 2 pcs</p>	<p>Q</p>  <p>Horizontal bar - 2 pcs</p>	

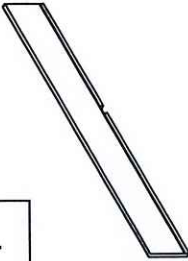
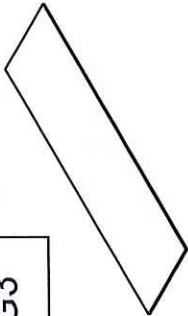
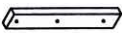



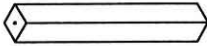











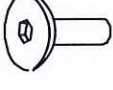

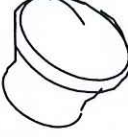

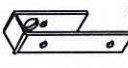

WF 284150 TWIN LOFT AND FULL BED

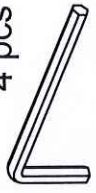
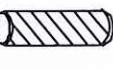
<p>A1</p>  <p>Support post - 2pcs</p>	<p>A2</p>  <p>Lower panel - 2pcs</p>	<p>A4</p>  <p>Horizontal bar - 2pcs</p>	<p>A5</p>  <p>Horizontal bar - 1pcs</p>
<p>A8</p>  <p>Horizontal bar - 4pcs</p>	<p>A9</p>  <p>Horizontal bar - 2pcs</p>	<p>A11</p>  <p>Horizontal bar - 2pcs</p>	<p>A12</p>  <p>Horizontal bar - 1pcs</p>
<p>A17</p>  <p>panel - 2pcs</p>	<p>A18</p>  <p>panel - 1pcs</p>	<p>J1</p>  <p>Leg - 1pcs</p>	<p>L</p>  <p>Hand guard rail - 1pcs</p>
<p>M</p>  <p>Leg - 2pcs</p>	<p>M1</p>  <p>Leg - 2pcs</p>	<p>A19</p>  <p>Lower panel - 2pcs</p>	<p>W1</p>  <p>6 pcs</p>

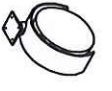
WF 284151 TWIN LOFT AND FULL BED



<p>A6</p>  <p>Horizontal bar - 4pcs</p>	<p>A10</p>  <p>panel - 4pcs</p>	<p>A13</p>  <p>panel - 1pcs</p>	<p>A14</p>  <p>panel - 1pcs</p>
<p>I</p>  <p>panel - 1pcs</p>	<p>X</p>  <p>panel - 2pcs</p>	<p>G</p>  <p>Drawer front - 6pcs</p>	<p>G2</p>  <p>Drawer left - right 12pcs</p>
<p>G1</p>  <p>Drawer back - 6pcs</p>	<p>G3</p>  <p>Bottom panel - 6pcs</p>	<p>N</p>  <p>Horizontal bar - 1pcs</p>	<p>N1</p>  <p>1pcs</p>
<p>W1</p>  <p>1pcs</p>	<p>W2</p>  <p>3pcs</p>	<p>A20</p>  <p>ExtraLeg -3pcs</p>	<p>N2</p>  <p>1pcs</p>

HARDWARE : WF 284149

<p>① Bolts-M6x30 -4pcs</p> 	<p>② Bolts-M6x40 -7pcs</p> 	<p>③ Bolts-M6x60 -4pcs</p> 	<p>④ Bolts-M6x100 -8pcs</p> 
<p>⑤ Bolts-M4x40 -12pcs</p> 	<p>⑥ Ø6x13 -24pcs</p> 	<p>⑦ M13 x15-8pcs</p> 	<p>⑧ Wood-screw 6x60-46pcs</p> 
<p>⑩ 12pcs</p> 	<p>⑪ 6 pcs</p> 	<p>⑫ 2 pcs</p> 	<p>⑬ 8 pcs</p> 
<p>⑬ screw 4x15-24pcs</p> 	<p>⑭ FLAT WASHER Ø5/16" -12 PCS</p> 	<p>⑮ Allen key M4 4 pcs</p> 	<p>⑯ Ø8X30 mm 51 pcs</p> 
<p>⑯ 2 pcs</p> 	<p>⑰ 2 pcs</p> 	<p>⑱ screw 4x20 -17pcs</p> 	<p>⑲ screw 4x30-97pcs</p> 
<p>⑳ 2 pcs</p> 	<p>㉑ 1 pcs</p> 	<p>㉒ Wood-screw 6x90-30pcs</p> 	<p>㉓ 21 Bolts-M6x80 -12pcs</p> 

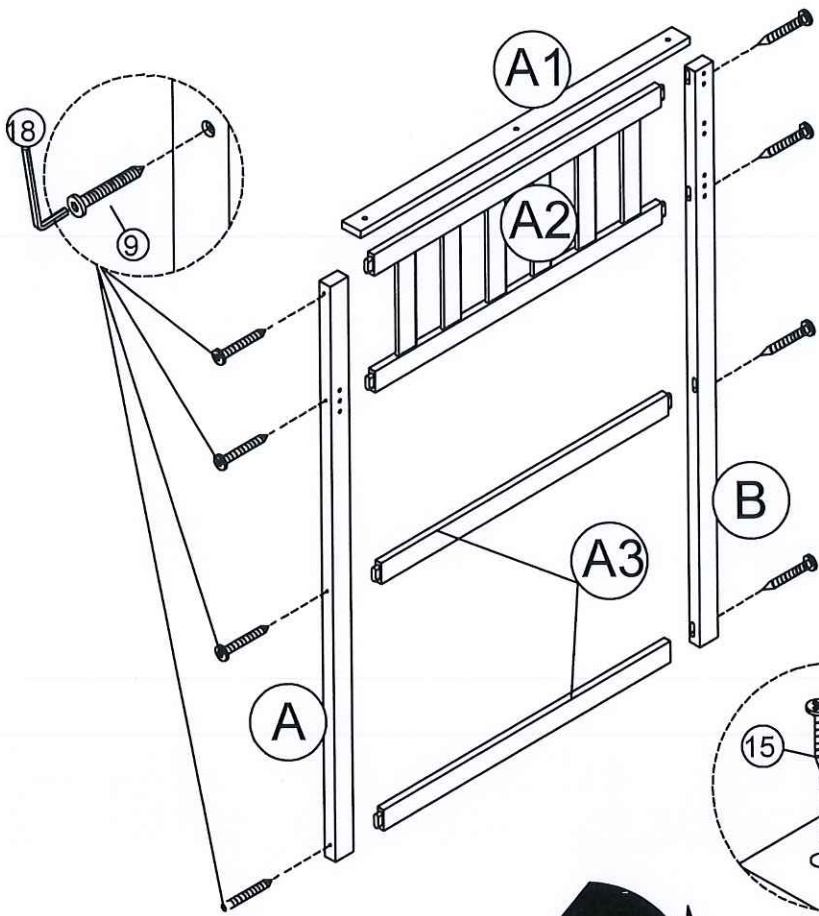

Step 1

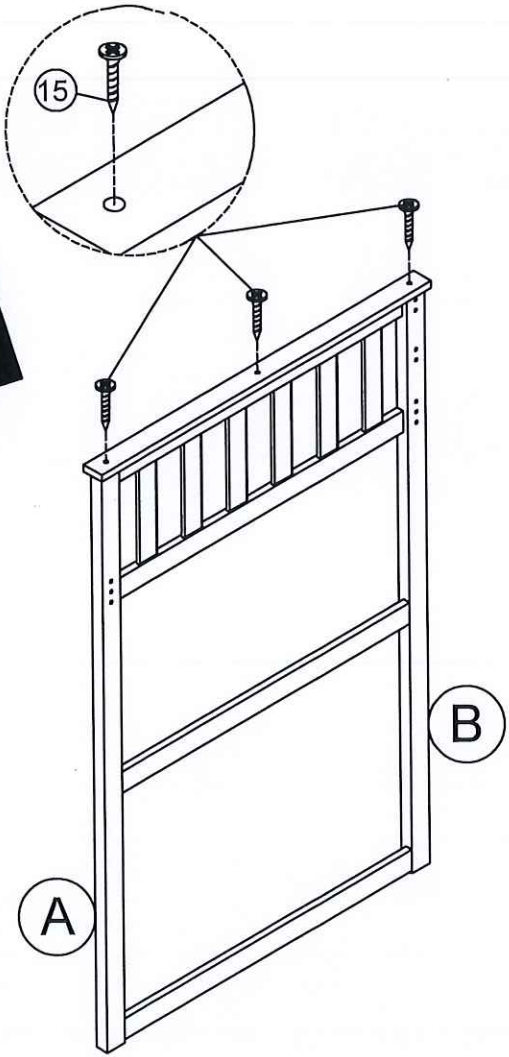

- | | |
|----|---|
| 9 |  |
| | 8PCS |
| 15 |  |
| | 3PCS |



Detail View

9	18	15
		
10pcs	1pcs	screw 4x30-3pcs

Step 2

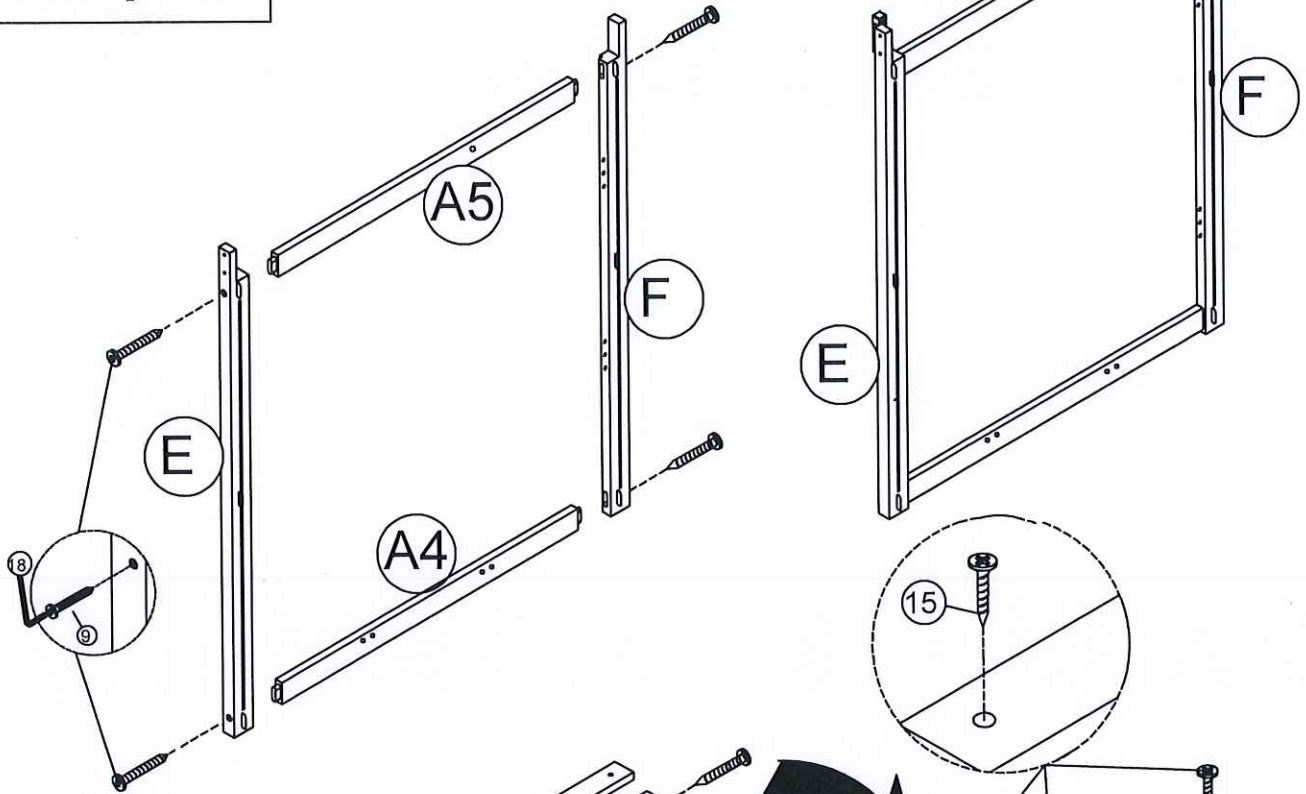

Step 3

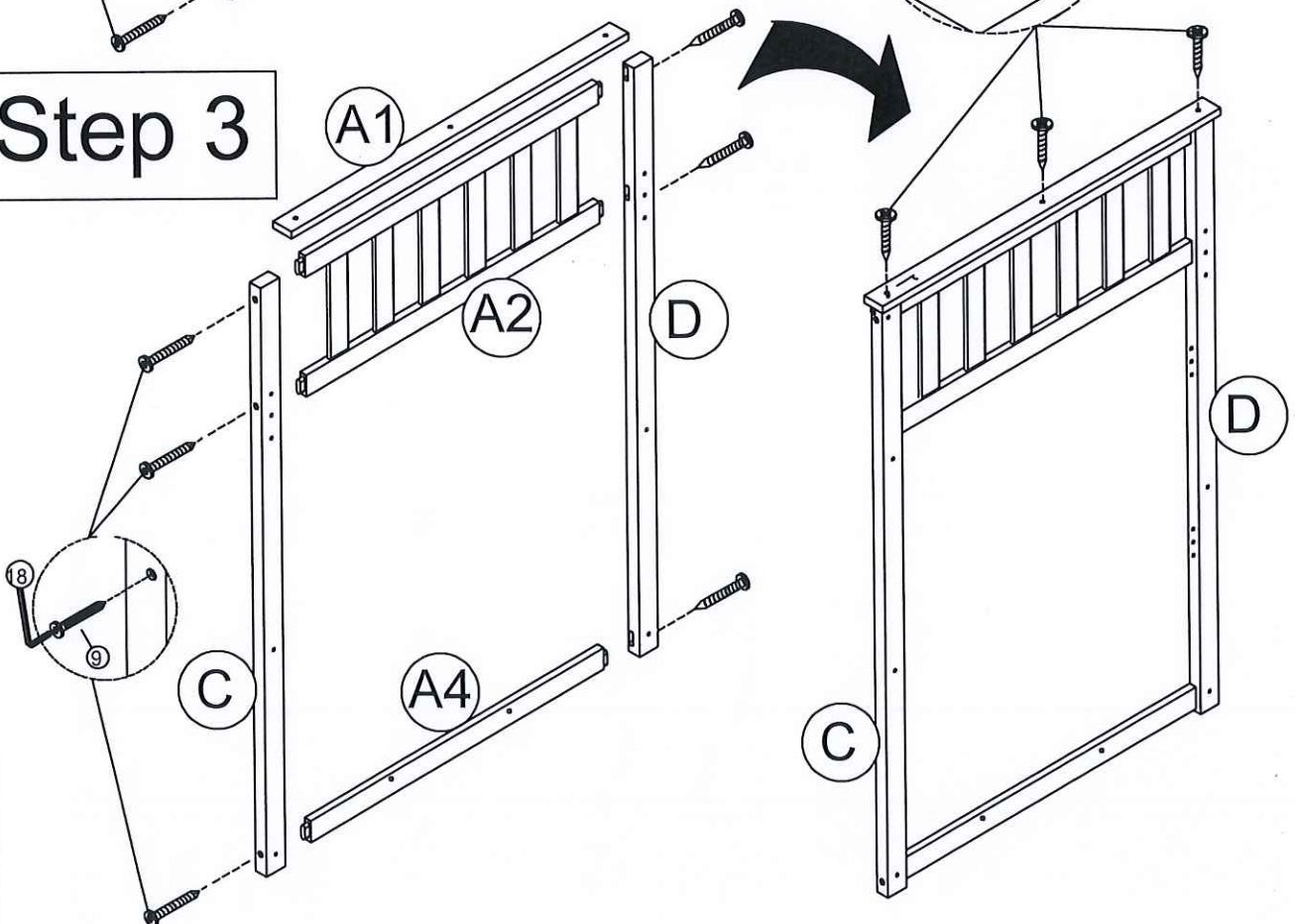

Detail View

8



16pcs

18



1pcs

Step 4

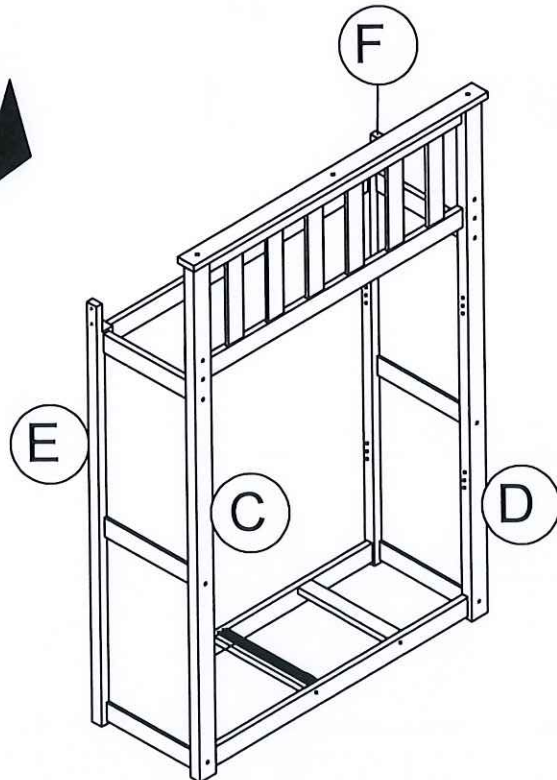
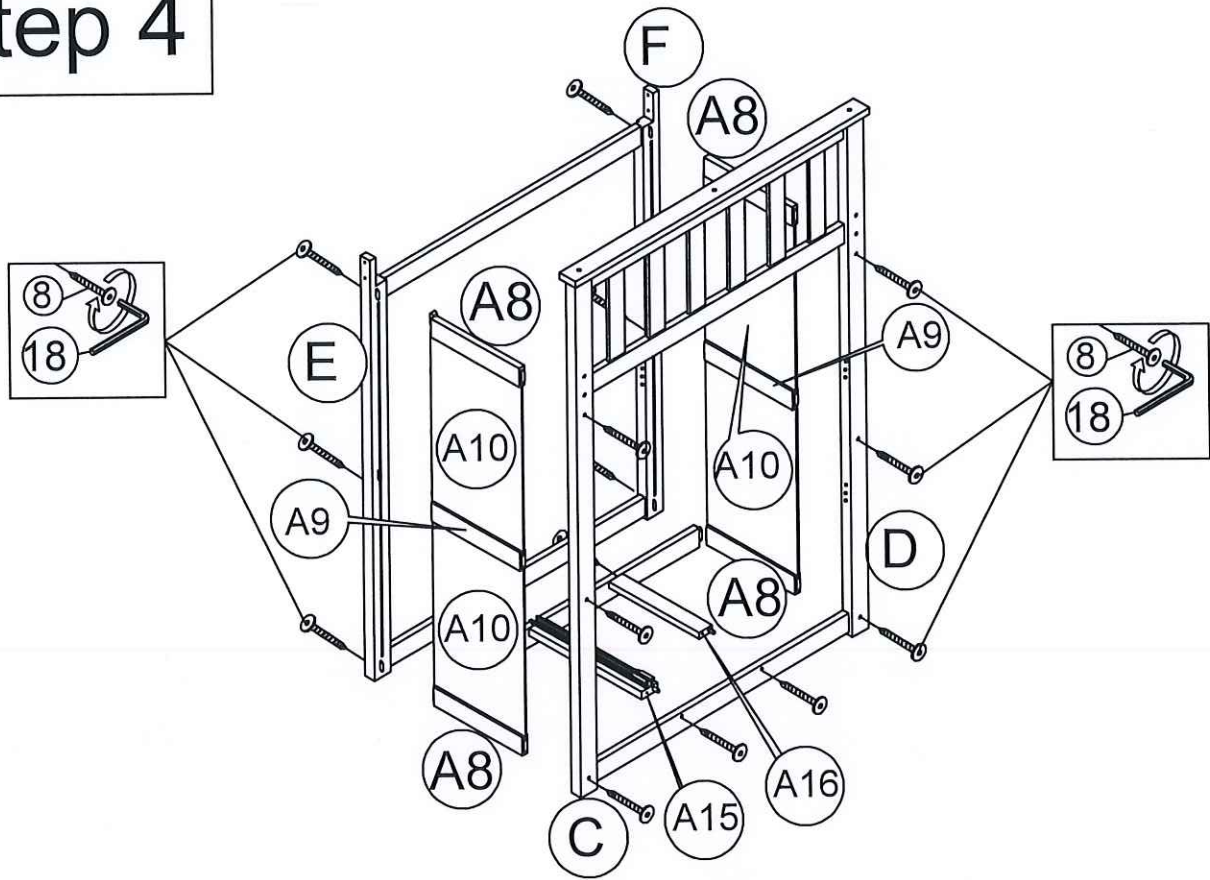

Detail View

Step 5 ⁸ 17 pcs ¹⁸ 1 pcs ⁹ 16 pcs **Step 6**

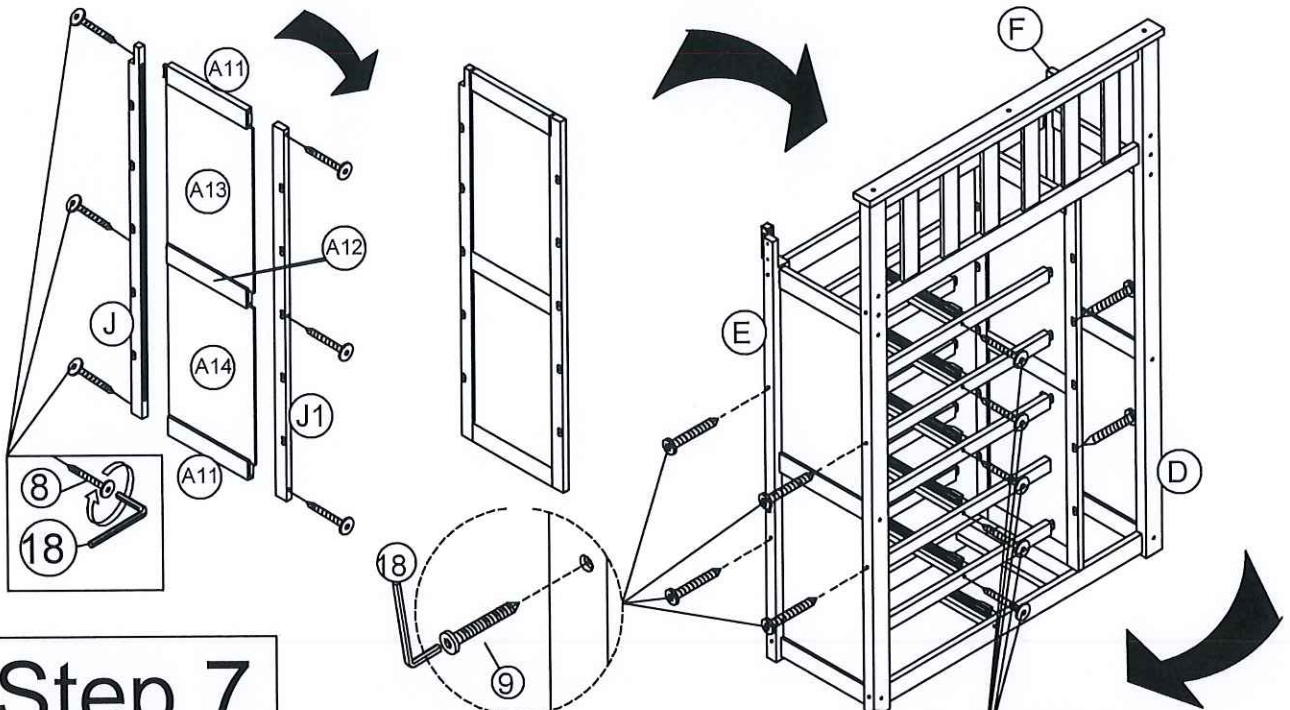

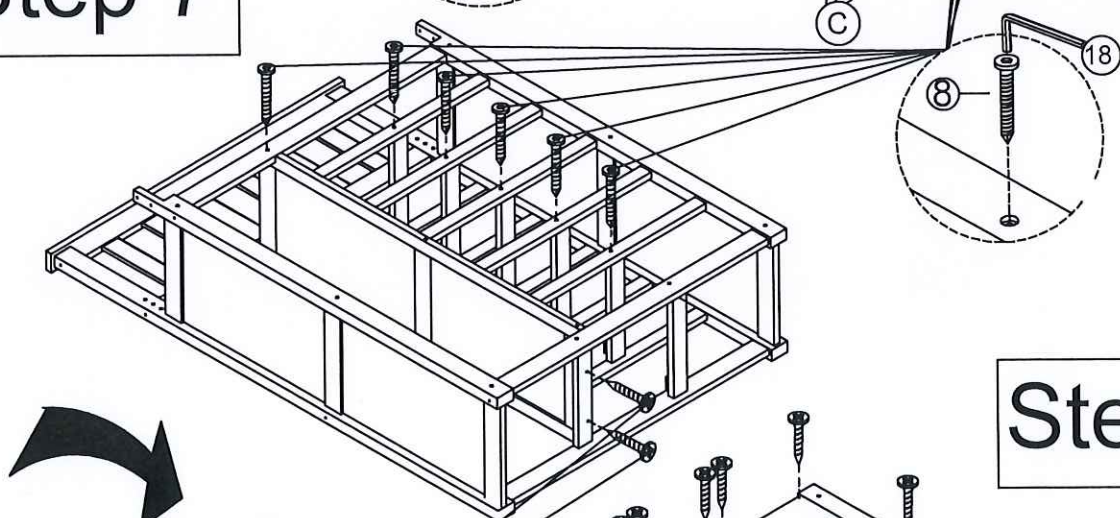

Step 7



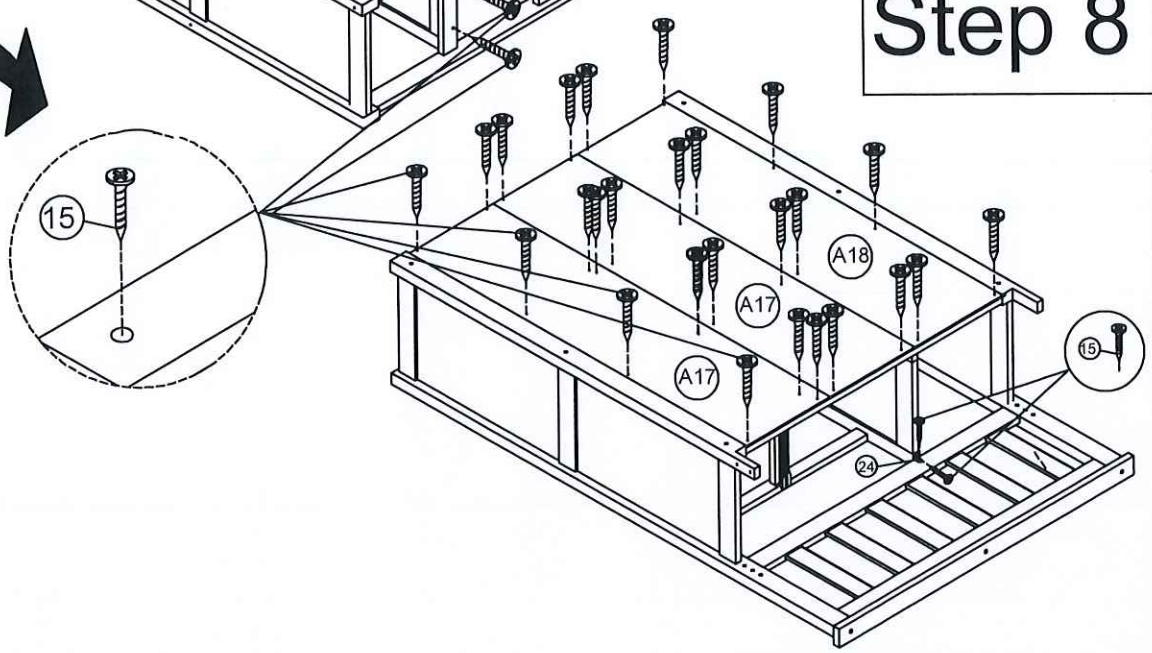

Step 8



Detail View

19	4	6
		
12 pcs	12 pcs	16 pcs

15	7	3
		
3 pcs	M13 x15-4pcs	4 pcs

Step 9

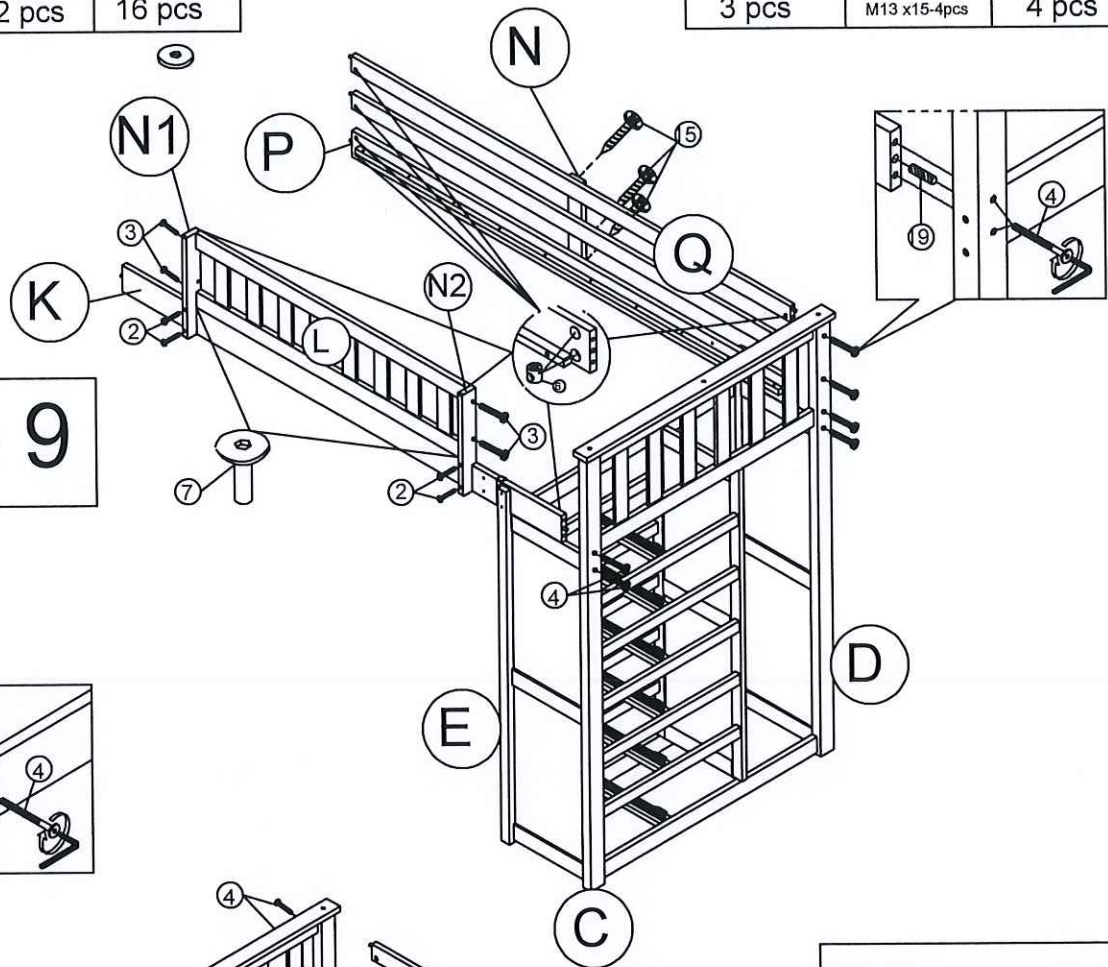

Step 10

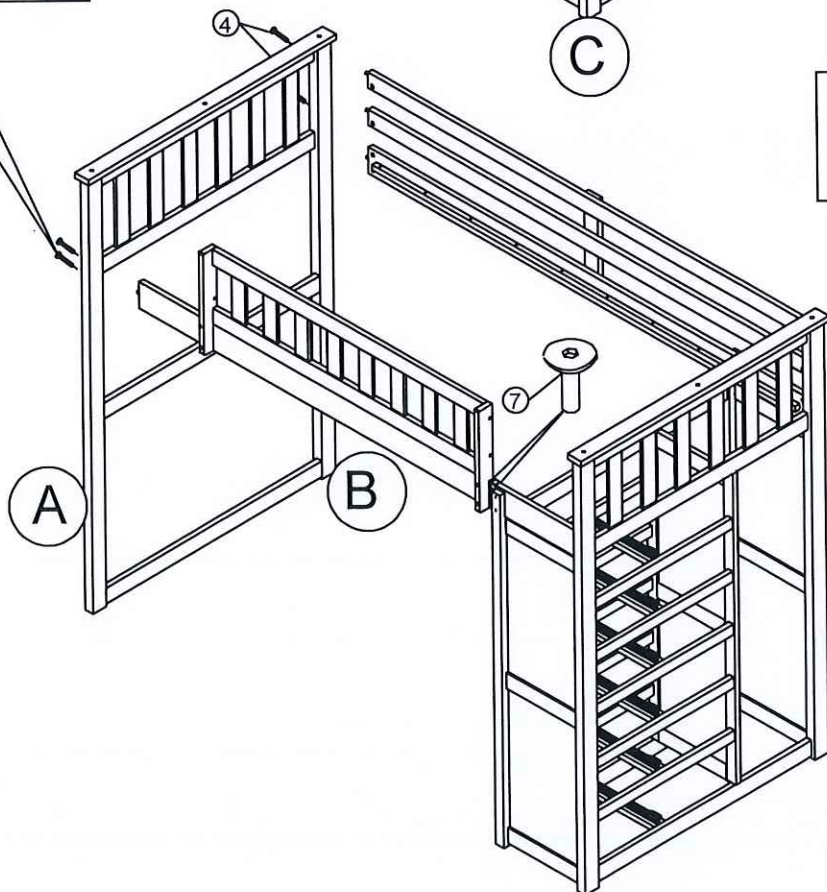

DETAIL VIEW

15



24PCS

14



13PCS

12



2PCS

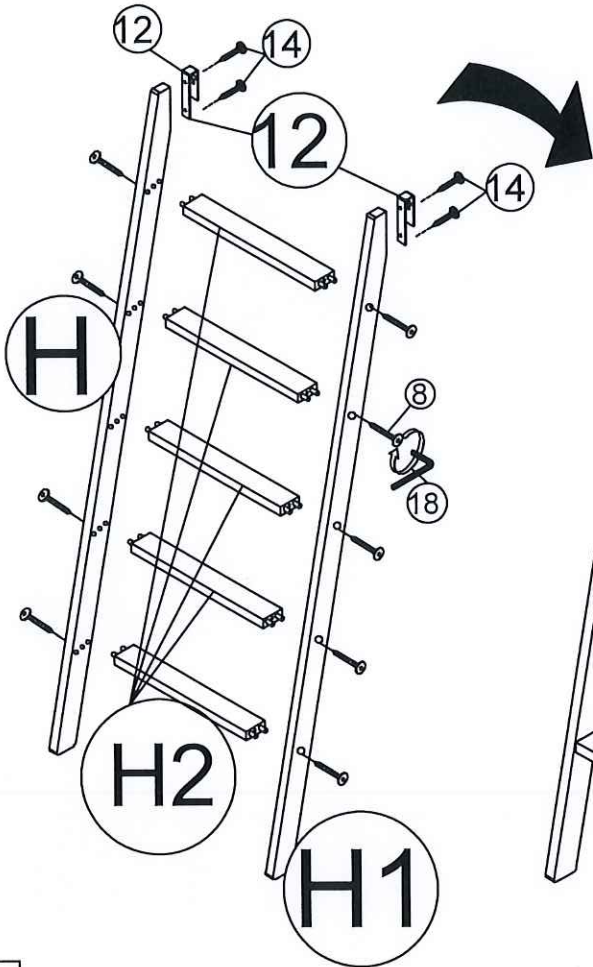

STEP 11

8



10PCS

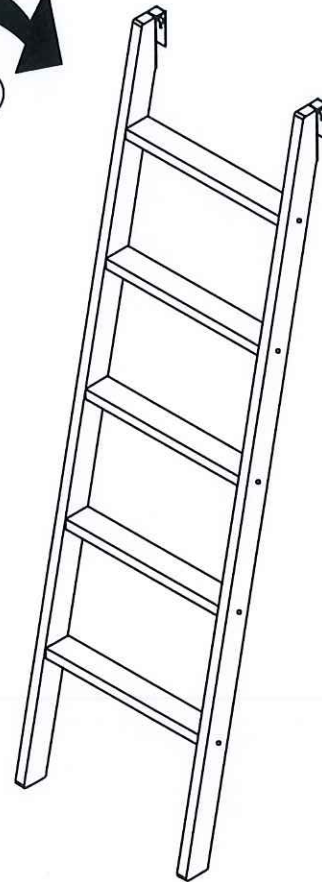

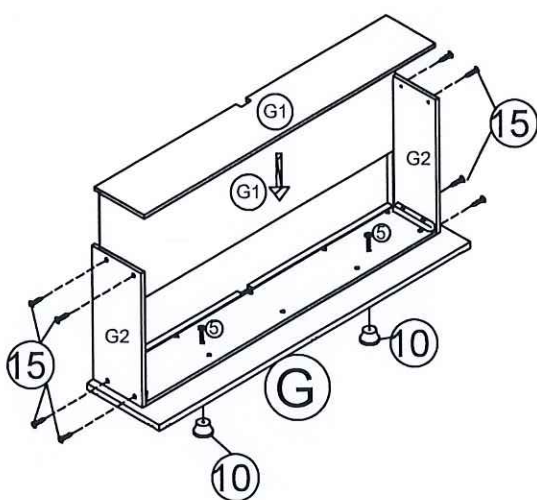

STEP 12

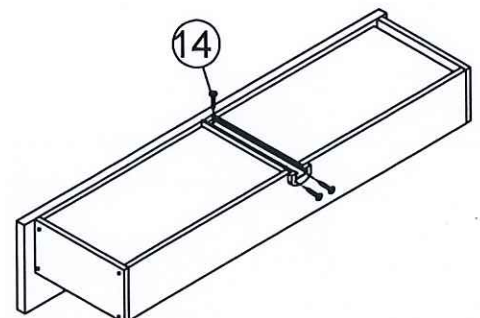
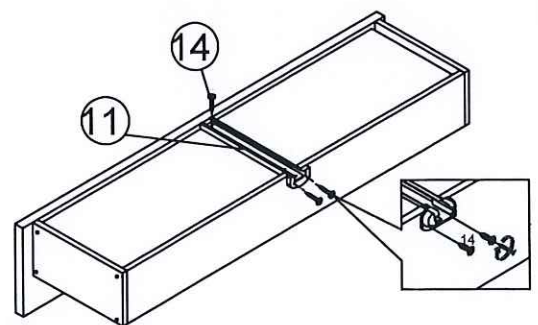

6PCS



DETAIL VIEW

14	15
	
4PCS	20PCS

