

CARE AND MAINTENANCE

Store outdoor furniture indoors or cover well when not in use.

Remove wooden furniture from standing water. Dust regularly with small brush or vacuum

Spills should be taken care of immediately before they harden or stain with a slightly dampened sponge.

NOTICE

- * Please make sure that you have all parts indicated before you begin assembly of this item
- * This item should be assembled on a soft surface to prevent scratching the finish during assembly
- * This item may require periodic tightening

Product Dimensions: 24.2" W x 41.3" D x 34.4" H

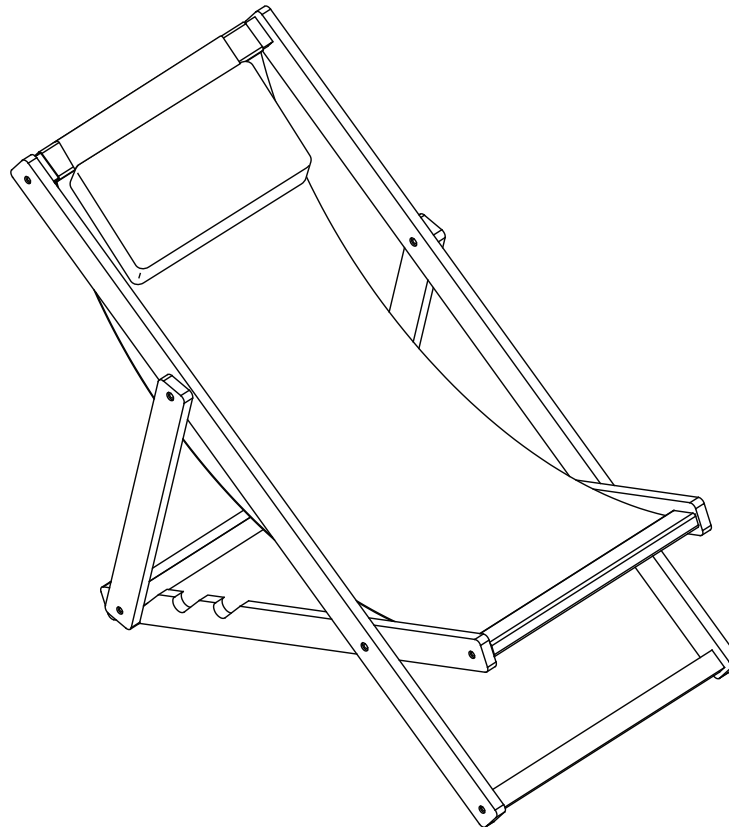

PREPARATION

Before beginning assembly of product, make sure all parts are present. Compare parts with package contents list and hardware contents list. If any part is missing or damaged, do not attempt to assemble the product.

Estimated Assembly Time: 30 minutes.

Tools Required for Assembly (included): Allen Key

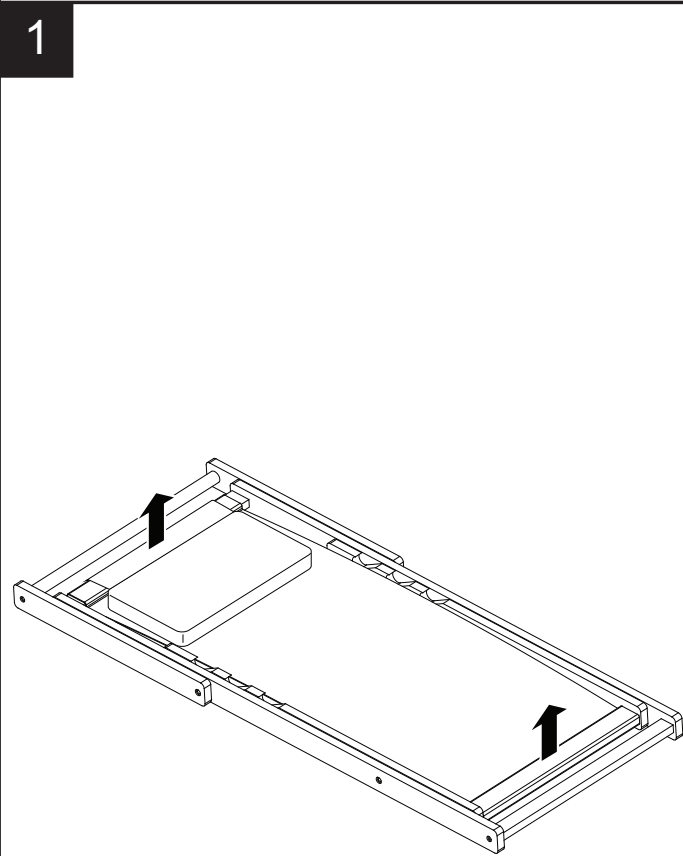

Step 1
Push up as arrow

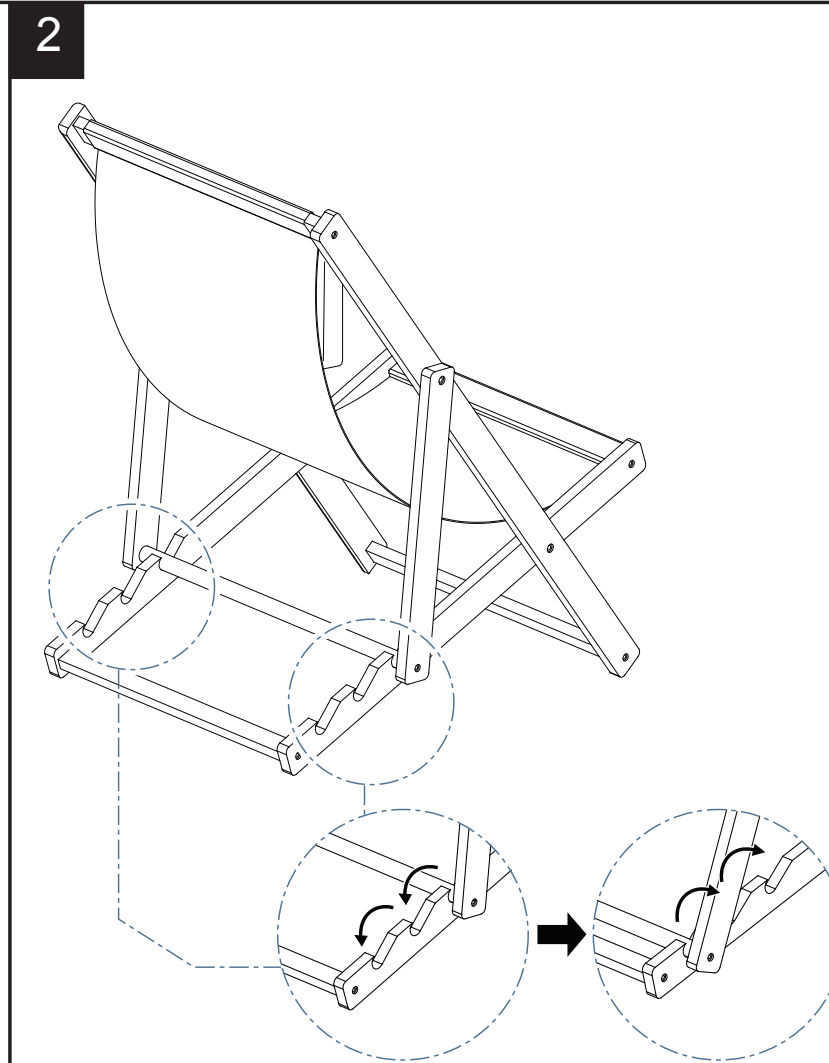

Step 2
Move the back support into the locks as shown

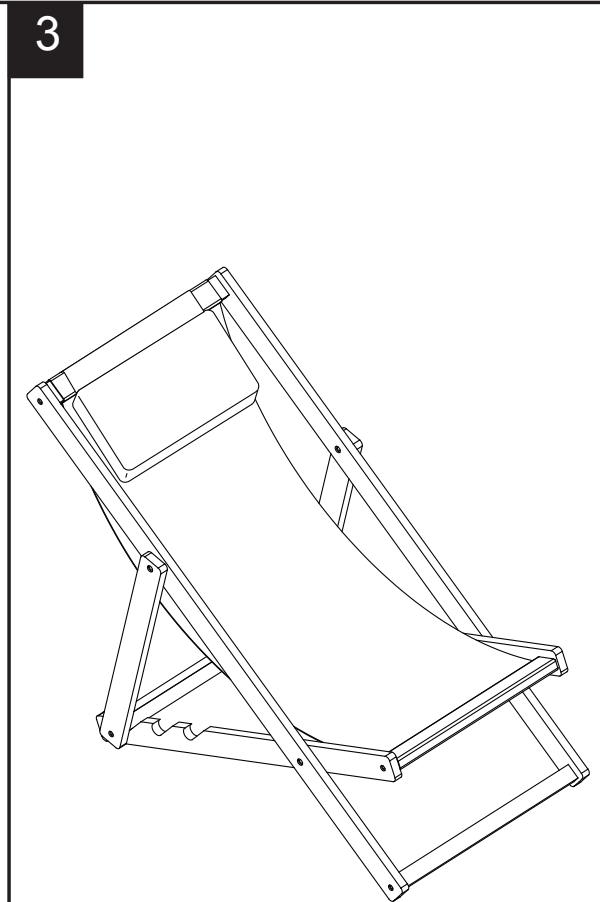

Step 3
Complete