

# dog cage

Product ID. QTNG5

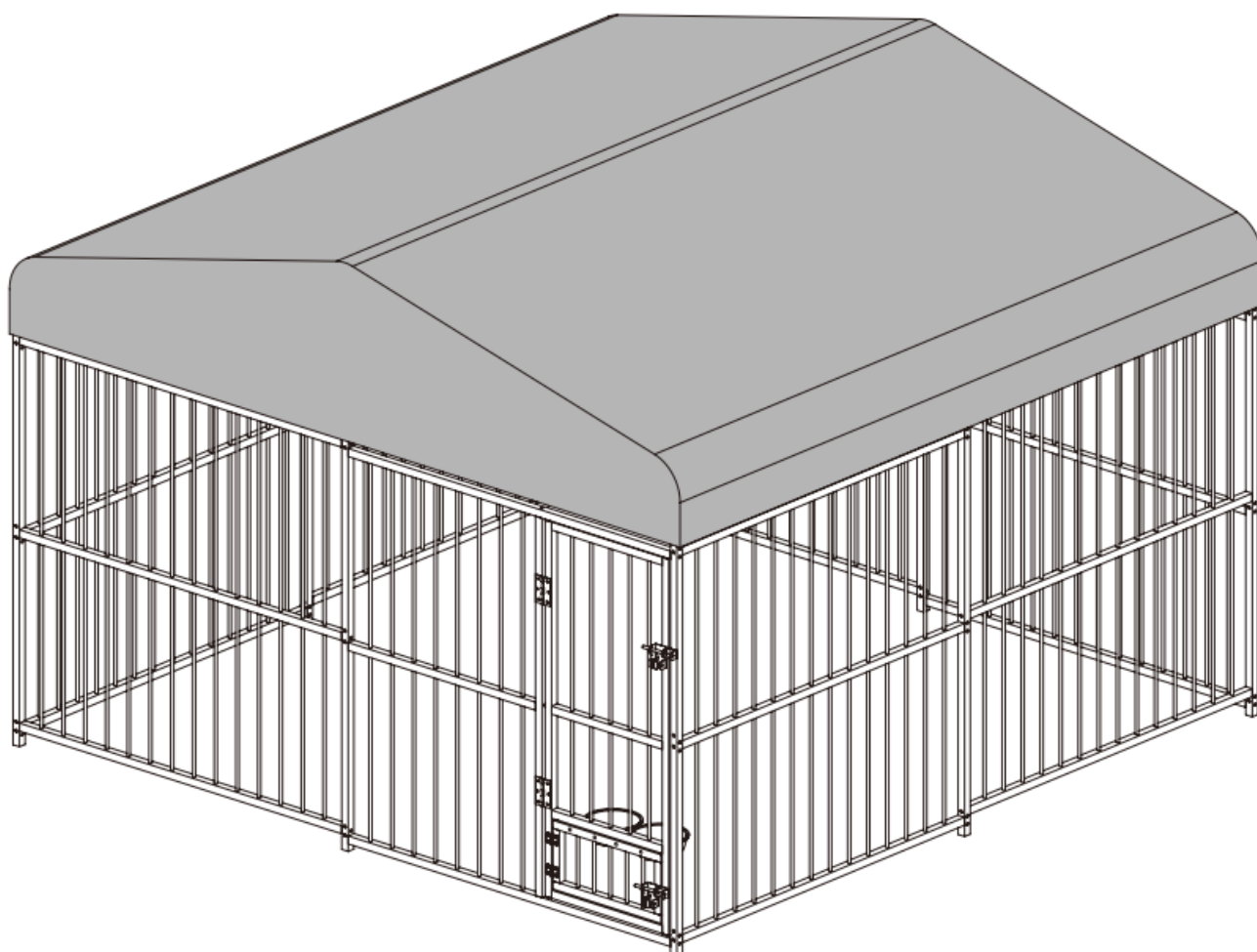

Scan for Support  
[support@garvee.com](mailto:support@garvee.com)



Distributed by  
**GARVEE**.com

V251223HF70

## Part list in box 1



1 x7pcs 1485mm



2 x14pcs 1447.5mm



3 x2pcs 1447.5mm



4 x7pcs 1447.5mm



6 x1pc 847.5mm



7 x1pc 1080mm



8 x2pcs 1000mm



D5 x1pc 1485mm

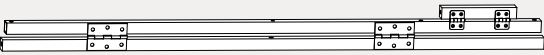

D1 x1pc 1300mm



9 x3pcs



10 x6pcs

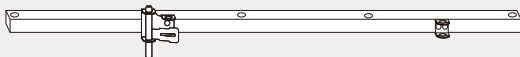

D2 x1pc 1300mm



11 x1pc 490mm

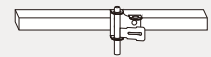

12 x1pc 200mm



D3 x2pcs 490mm



D4 x1pc 490mm



13 x1pc 470mm

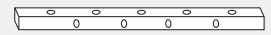

14 x1pc 470mm



15 x2pcs



16 x2pcs



D x 6pcs

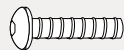

E x 69pcs



H x7pcs



F x1pc Roof Cover



G x12pcs

## Part list in box 2



A x106pcs 1370mm



B x5pcs 970mm



J x5pcs 245mm

# Step 1

Install the base and column. Insert the D5 tube first, with the lock hole facing outwards, then install the other #1 tubes, which are inserted in the same direction as the D5 tube.

NOTE: The thin end faces upwards

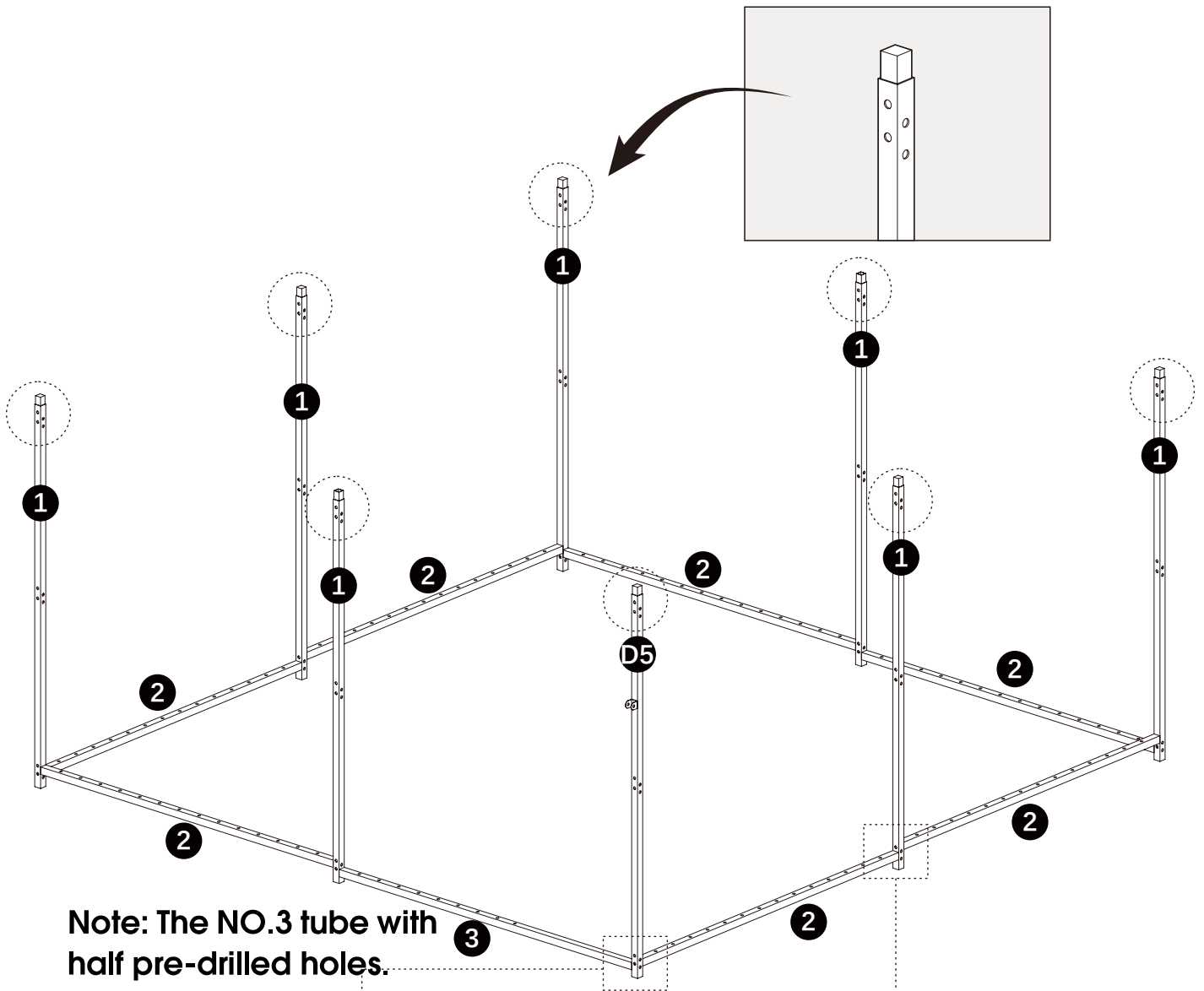

Note: The NO.3 tube with half pre-drilled holes.

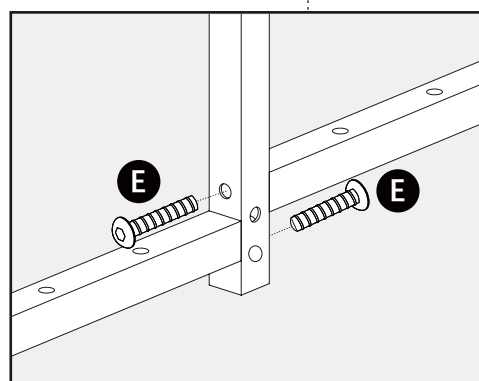
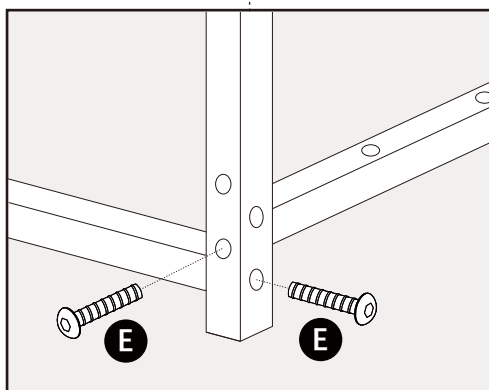

\*Note: Please attach the NO.3 tube first, and the NO.3 tube must be under NO.2 tube as bellow.

## Step 2

Install the middle cross bars.

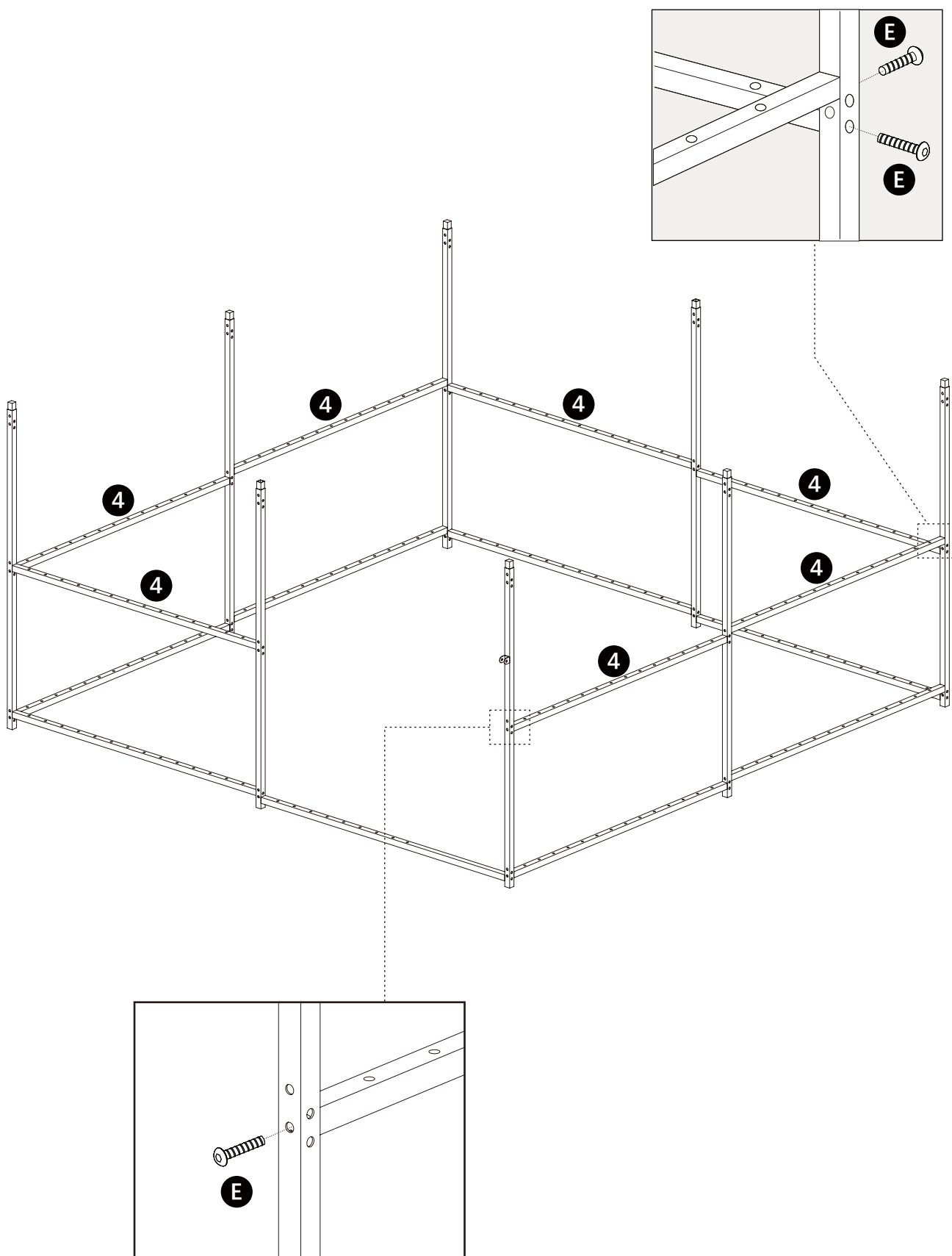

# Step 3

Door fixing.

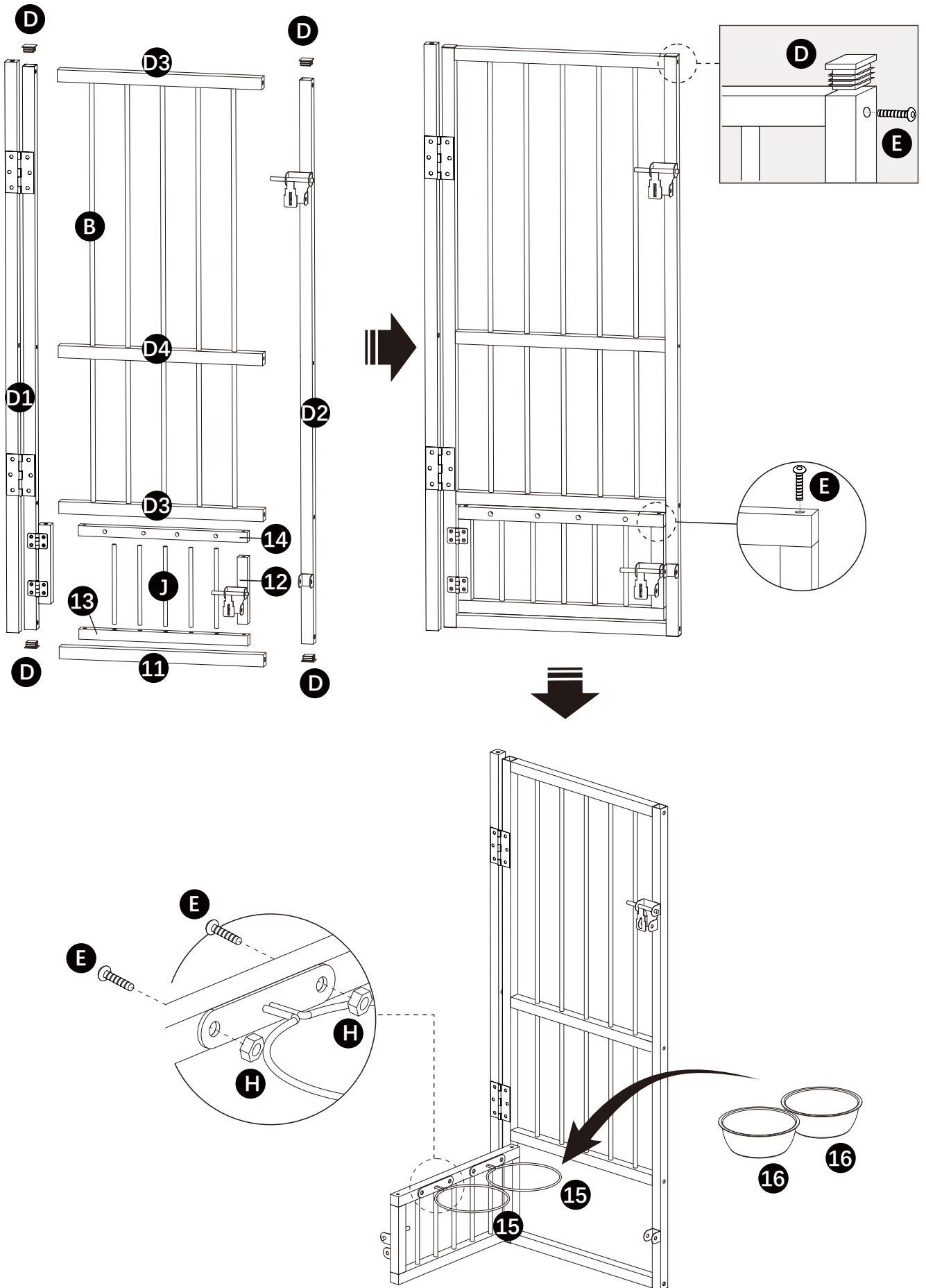

## Step 4

Install facade pipes.

Install the pipe No.3 and "D1", fasten the pipes with screw "E".

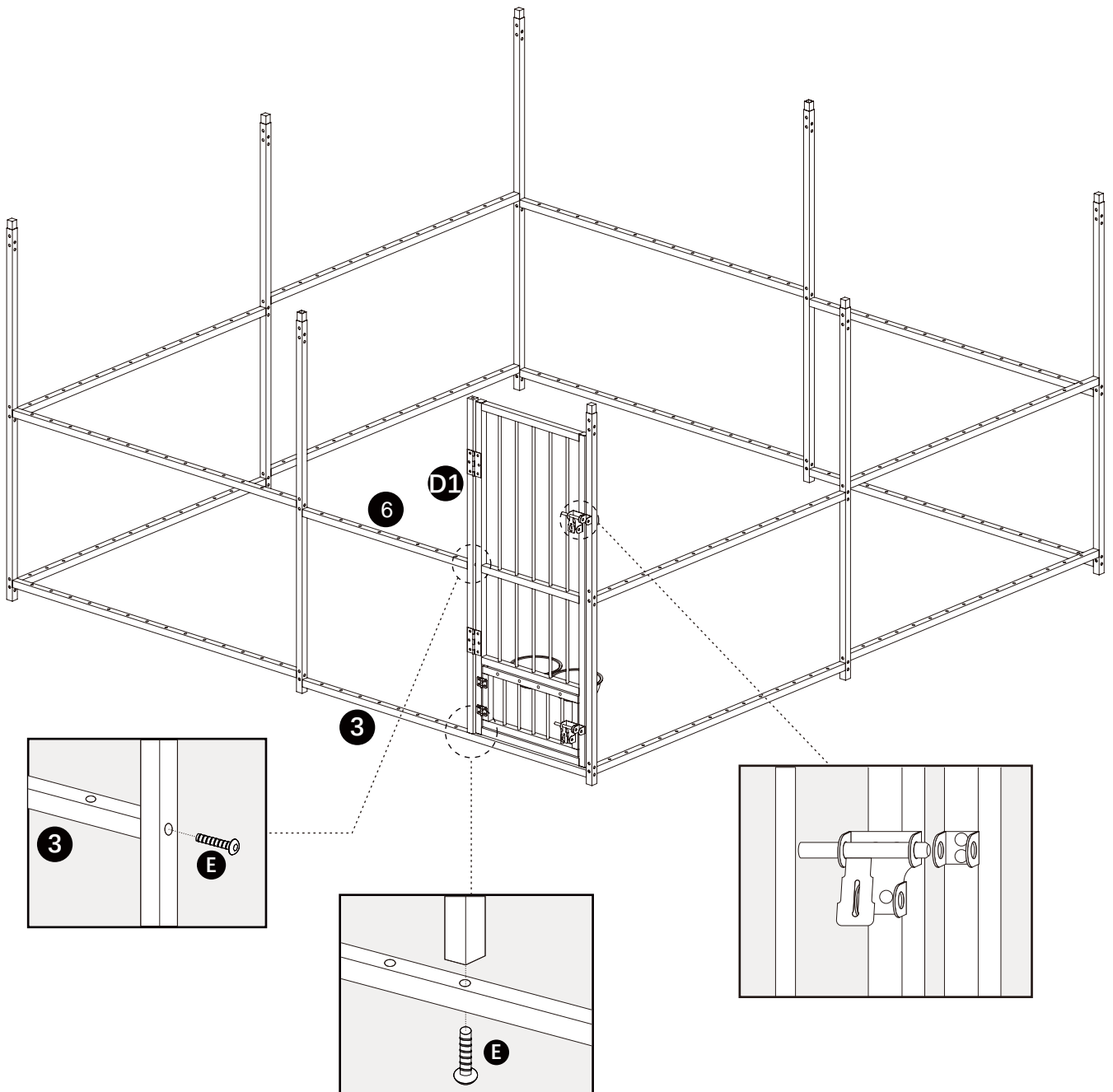

## Step 5

Insert all the circular tube "A" as a grid.

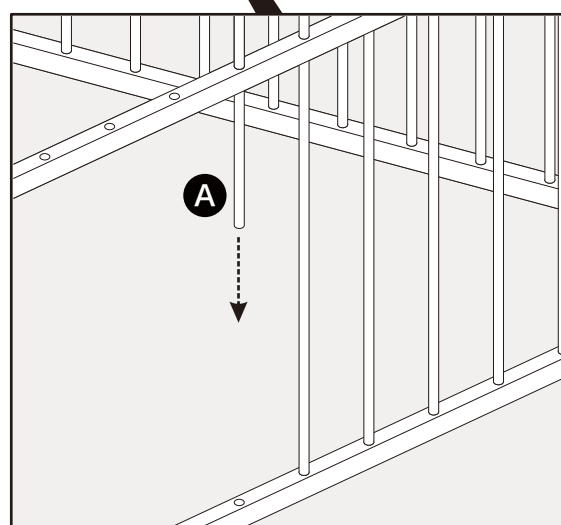
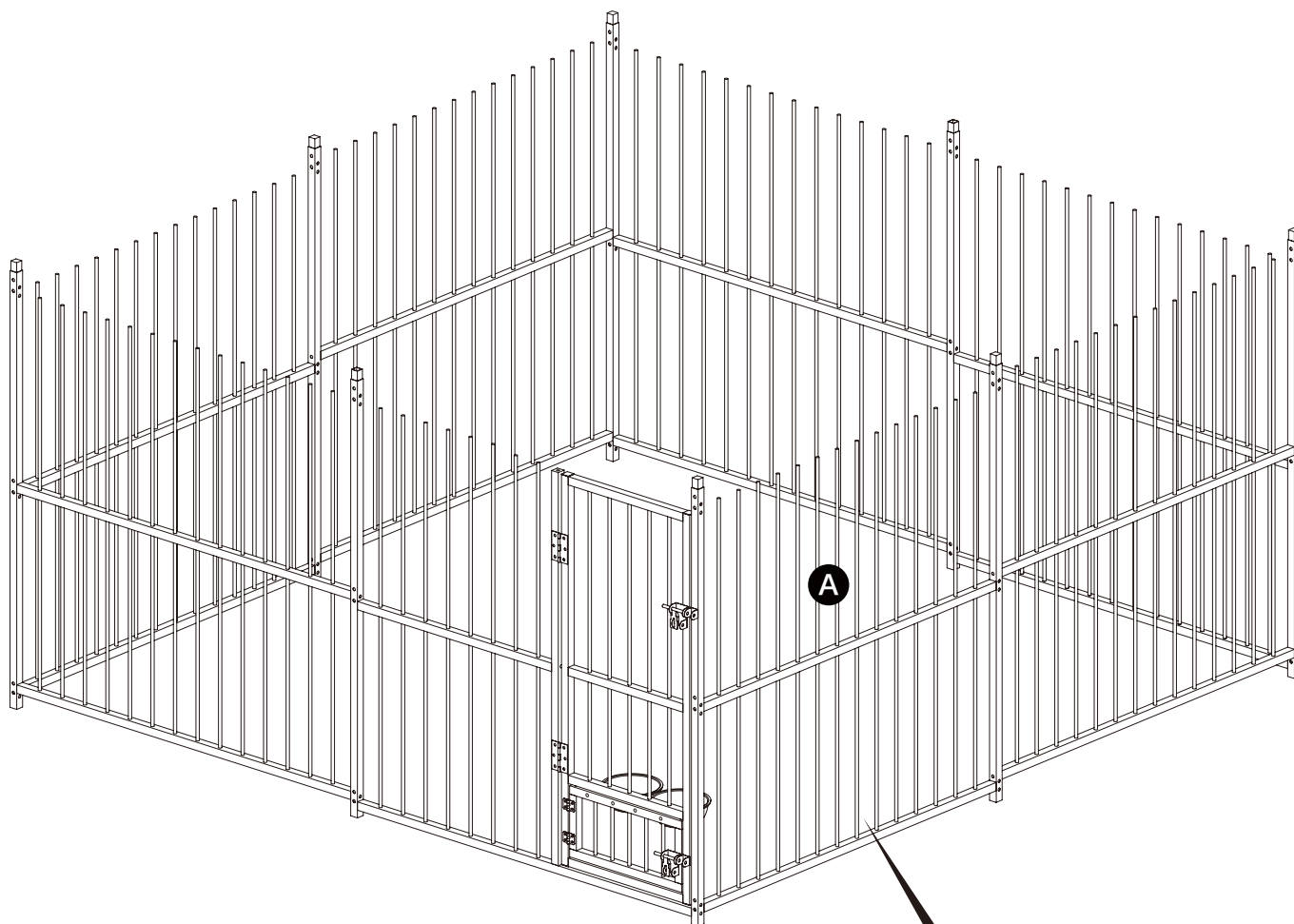

## Step 6

Install the top beam pipe.

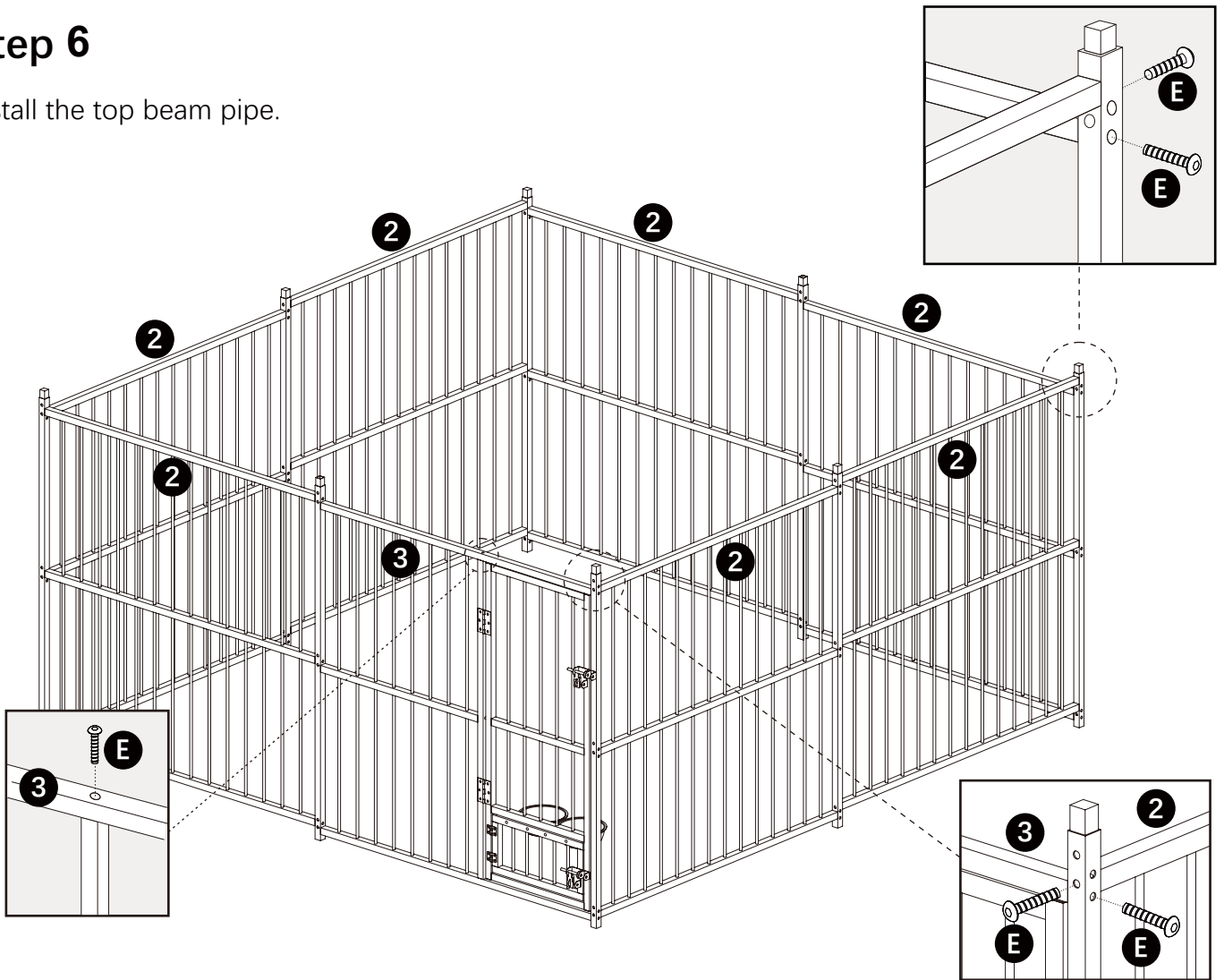

## Step 7

Insert tubes #9 and #10 into the corresponding standing tubes firstly, then connect the #9 and #10 tubes in the middle.

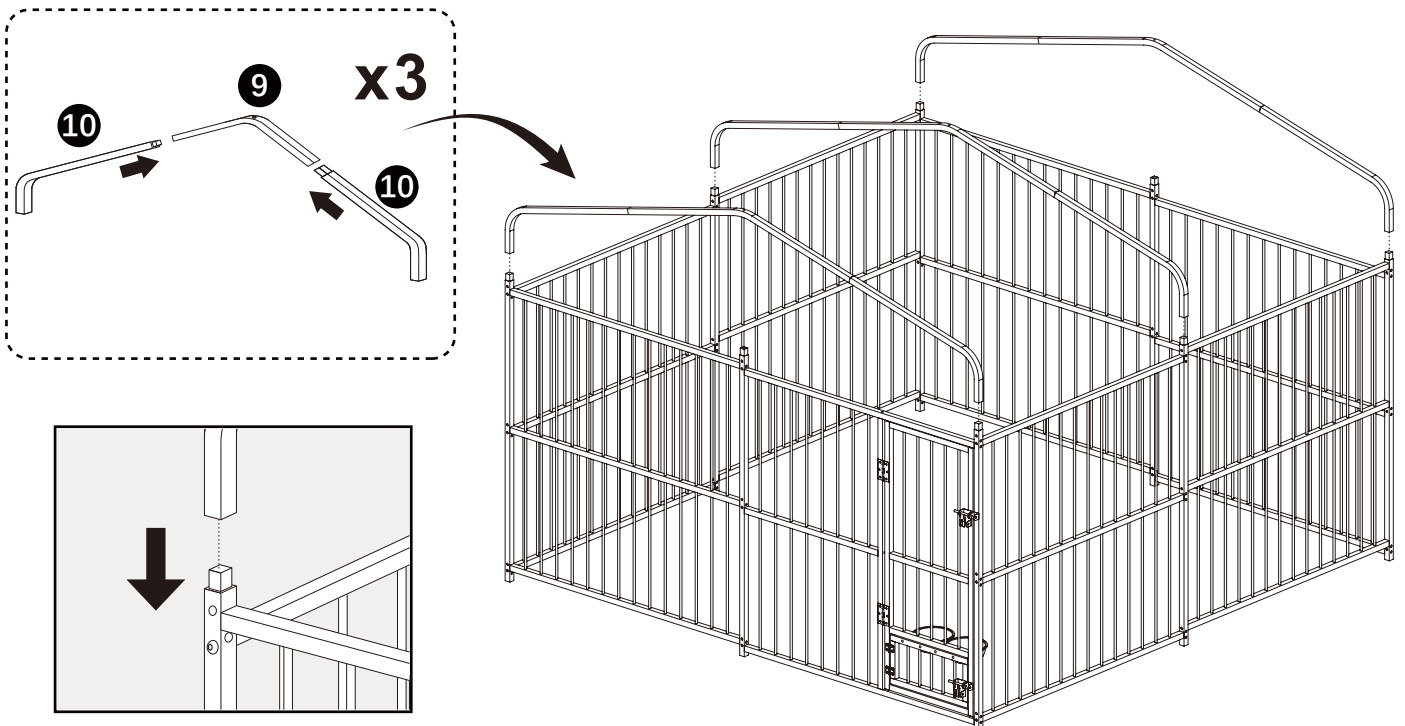

## Step 8

Note: Insert the plastic tube plugs "D" at both ends of the tube.

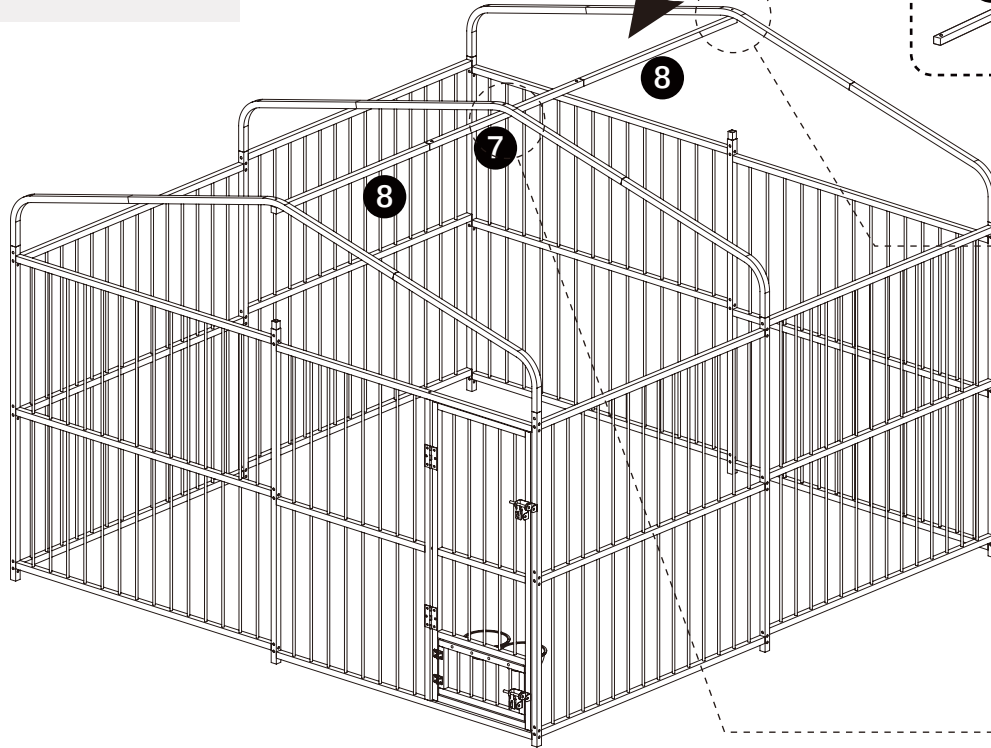
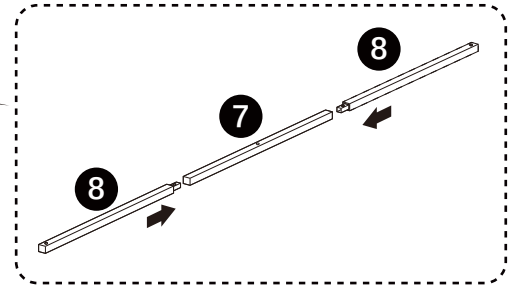
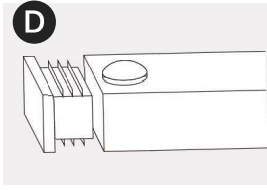

Note: Place tube NO.8 under tube NO.9, and fix them with screw E.

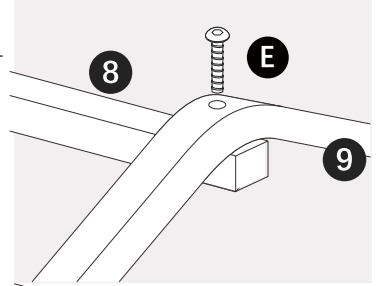

Note: The middle position needs to be secured with screw E and nut H.

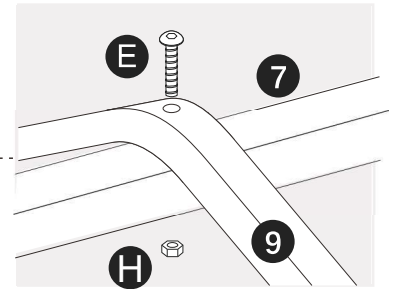

## Step 9

Cover the roof fabric.

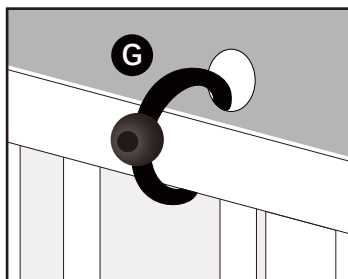

Fix the cover to the frame with G.

