

Instruction Manual

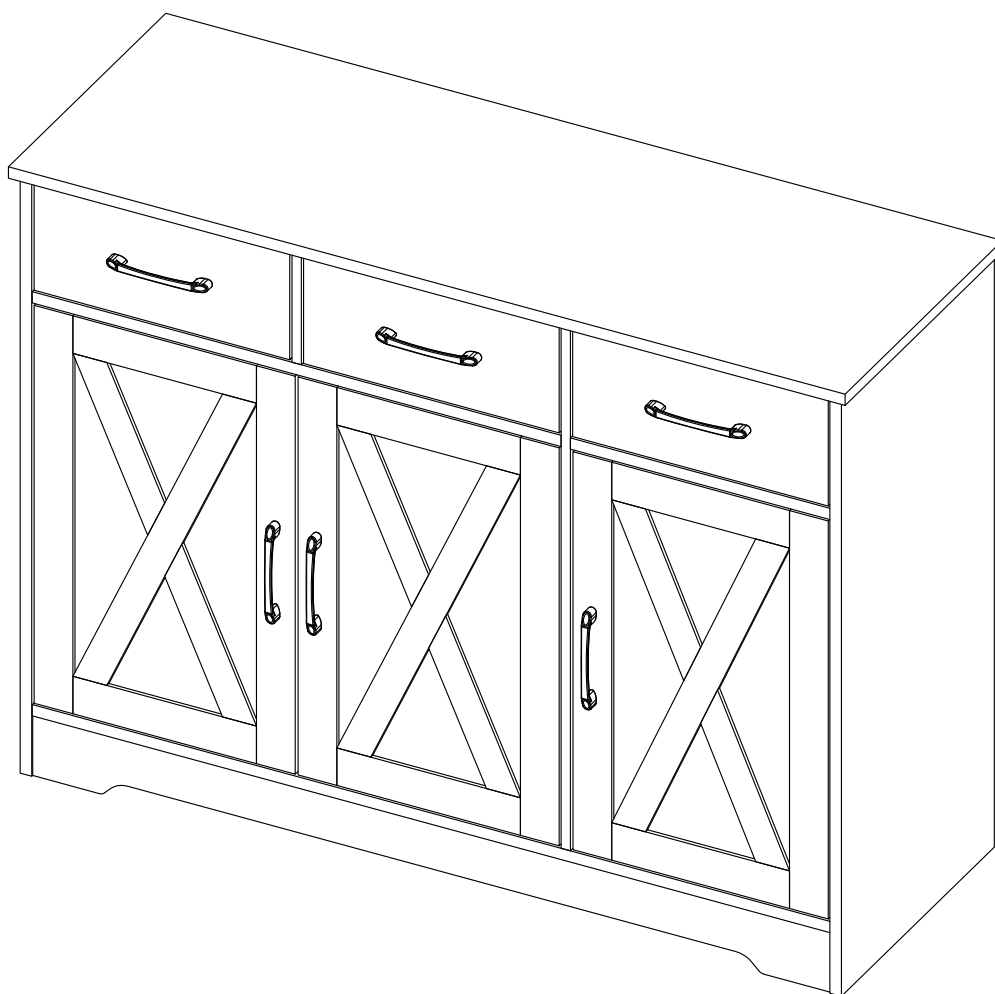

Kitchen island

EN

Thank you for purchase on our products. Please contact us if you have difficulty with assembly or need replacement parts. Our customer service is here to assist you. Please attach your User Name or Order ID so that we can assist you better.

WARNING

Serious or fatal injury may occur from unexpected assembly or use.

1. During the assembly process, keep all parts away from babies or children.
2. Always securely fix this product to the wall. Make sure the wall area to be drilled is free from hidden electrical wires, water and gas pipes.
3. Use of tip-over restraints may only reduce, but not eliminate the risk of tip-over.
4. Unless specially designed to accommodate, do not set heavy objects on top of this product.
5. Place the heaviest items on the lowest shelf.
6. Never allow children to climb or bang on drawers, doors or shelves.

DE

Vielen Dank für Ihren Kauf von uns Produkten. Bitte kontaktieren Sie uns, wenn Sie Probleme mit Montage haben oder Ersatzteile benötigen. Wir Kundenservice ist für Sie da. Bitte geben Sie Ihren Benutzernamen oder Ihre Bestellnummer an, damit wir Sie besser unterstützen können.

WARNUNG







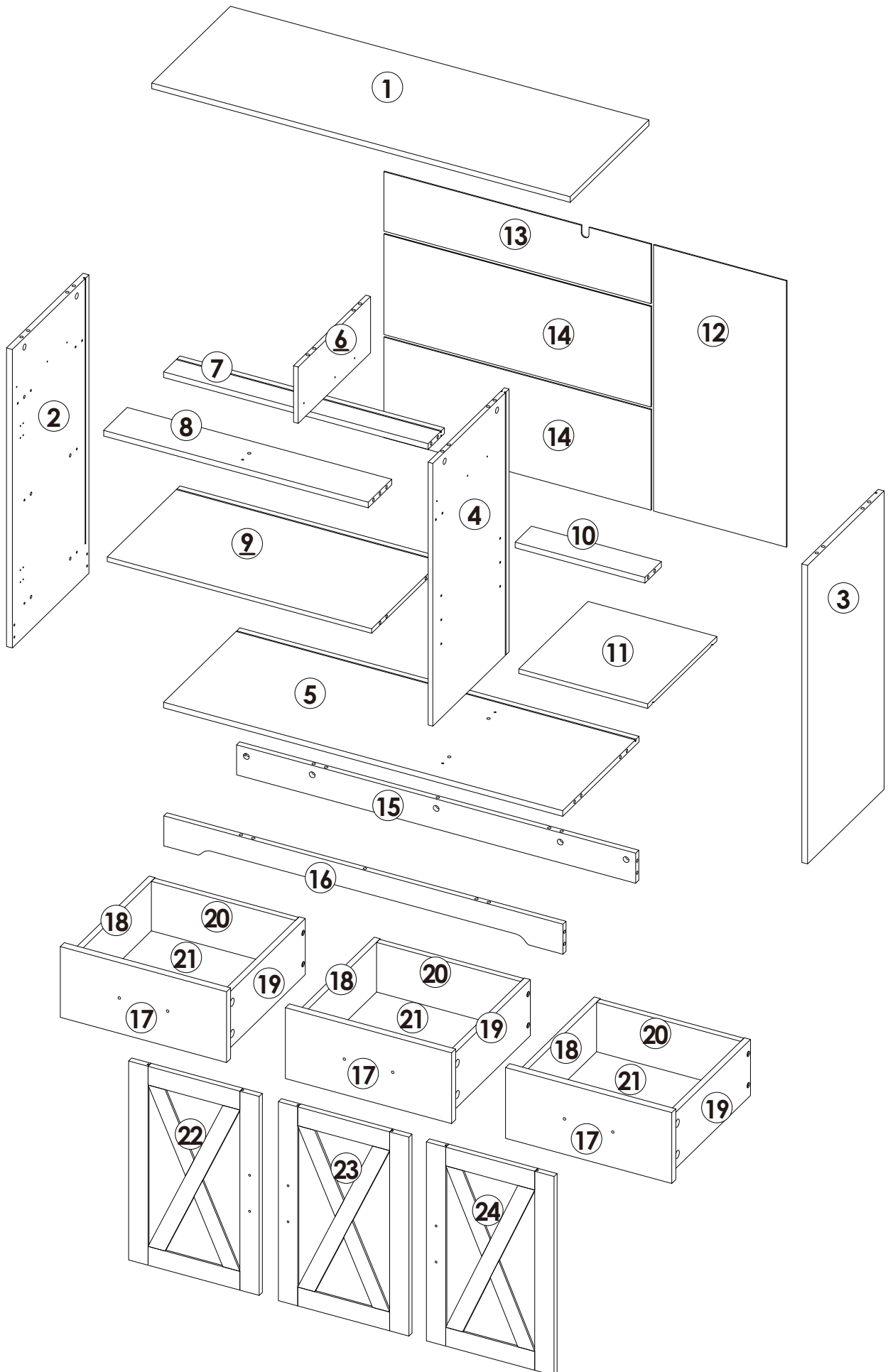





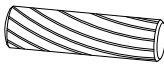
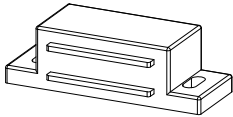
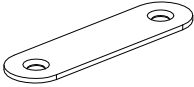

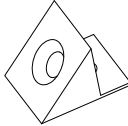
Bei unerwarteter Montage oder Verwendung können schwere oder tödliche Verletzung auftreten.

1. Legen Sie in den Montageprozess alle Teile weg von Babys oder Kindern.
2. Stellen Sie sicher, dass der gebohrte Wandbereich frei von verborgenen Stromkabeln, Wasser- und Gasleitungen ist, wenn Sie dieses Produkt an der Wand befestigen.
3. Die Verwendung von Kippsicherungen kann die Gefahr eines Kippens nur verringern, jedoch nicht beseitigen.
4. Setzen Sie bitte keine schweren Gegenstände auf dieses Produkt, es sei denn, dass das Produkt speziell für die Unterbringung konzipiert wird.
5. Legen Sie bitte die schwersten Gegenstände auf das unterste Regal.
6. Erlauben Sie nie Kindern, auf Schubladen, Türen oder Regale zu klettern oder zu knallen.

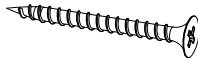
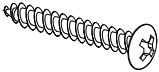
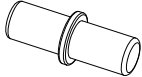
Parts List(EN) / Teile Liste(DE)

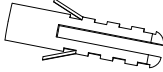
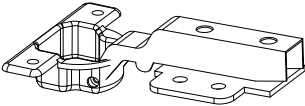



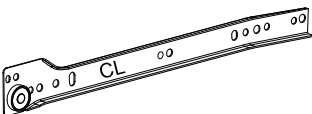
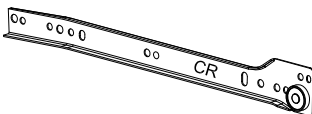
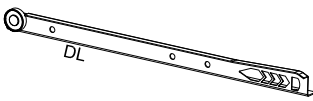
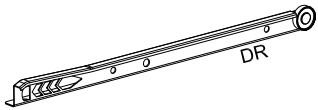

Parts List(EN) / Teile Liste(DE)

<p>A</p>  <p>M6×32mm 50+2PCS</p>	<p>B</p>  <p>∅15×9.5mm 50+2PCS</p>	<p>C</p>  <p>∅6×30mm 30+2PCS</p>	<p>D</p>  <p>3PCS</p>
<p>E</p>  <p>3PCS</p>	<p>F</p>  <p>M3×10mm 6PCS</p>	<p>G</p>  <p>16+2PCS</p>	<p>H</p>  <p>M3×14mm 16+2PCS</p>
<p>I</p>  <p>M3×15mm 6PCS</p>	<p>J</p>  <p>M3.5×12mm 66+4PCS</p>	<p>K</p>  <p>M4×40mm 16+2PCS</p>	<p>L</p>  <p>M4×32mm 1PC</p>
<p>M</p>  <p>∅5×16mm 4PCS</p>	<p>N</p>  <p>6PCS</p>	<p>O</p>  <p>M4×20mm 12+1PCS</p>	<p>P</p>  <p>∅6×30mm 1PC</p>
<p>Q</p>  <p>6PCS</p>	<p>R</p>  <p>M4×12mm 1PC</p>	<p>S</p>  <p>M4 1PC</p>	<p>T</p>  <p>72×25×15mm 1PC</p>
<p>CL</p>  <p>L300mm 3PCS</p>	<p>CR</p>  <p>L300mm 3PCS</p>	<p>DL</p>  <p>L300mm 3PCS</p>	<p>DR</p>  <p>L300mm 3PCS</p>

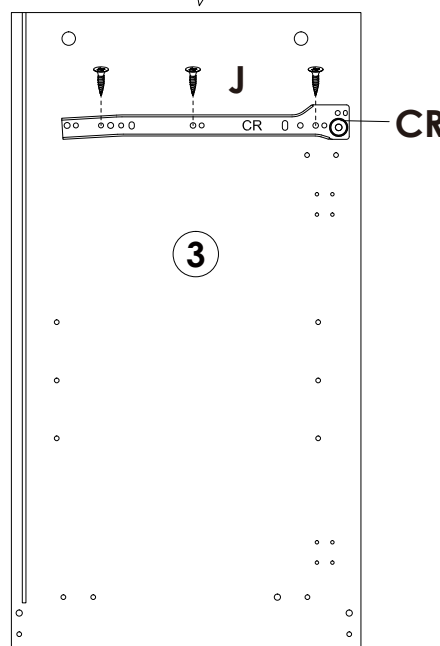
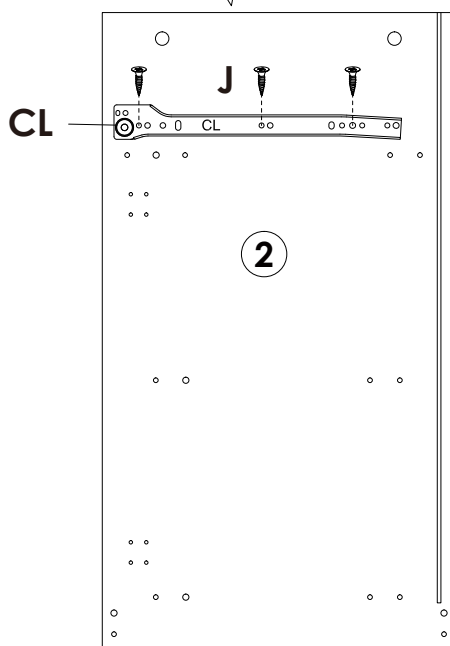
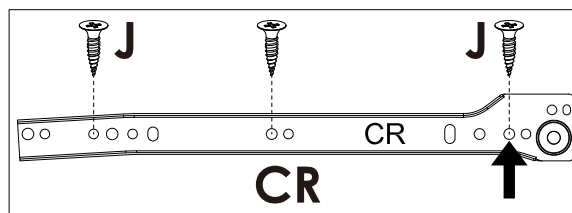
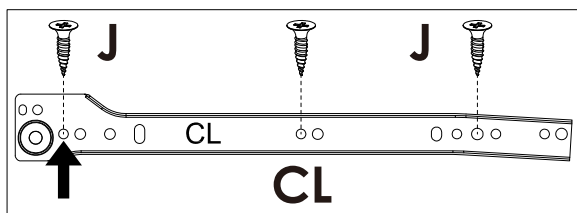
Assembly Steps(EN) / Montageschritte(DE)

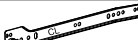

STEP 1

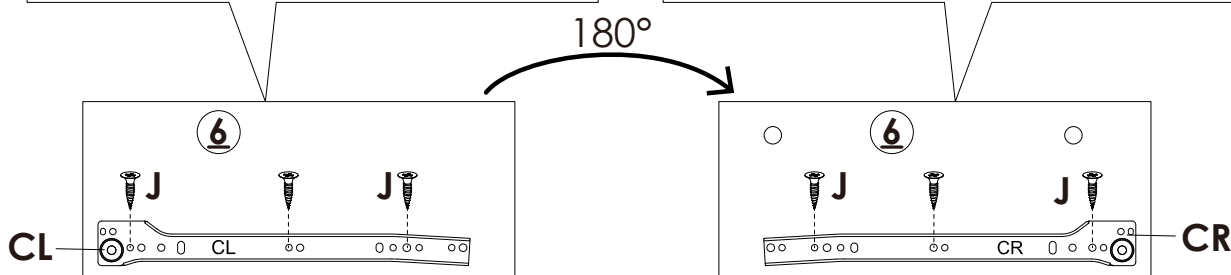
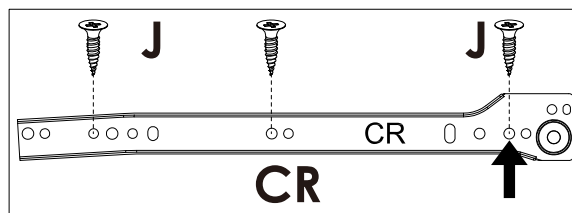
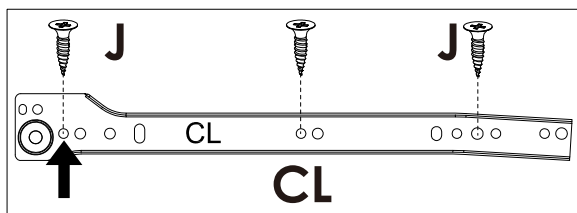

	J x 6PCS
	CL x 1PC
	CR x 1PC

STEP 2

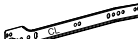



	J x 6PCS
	CL x 1PC
	CR x 1PC

Assembly Steps(EN) / Montageschritte(DE)

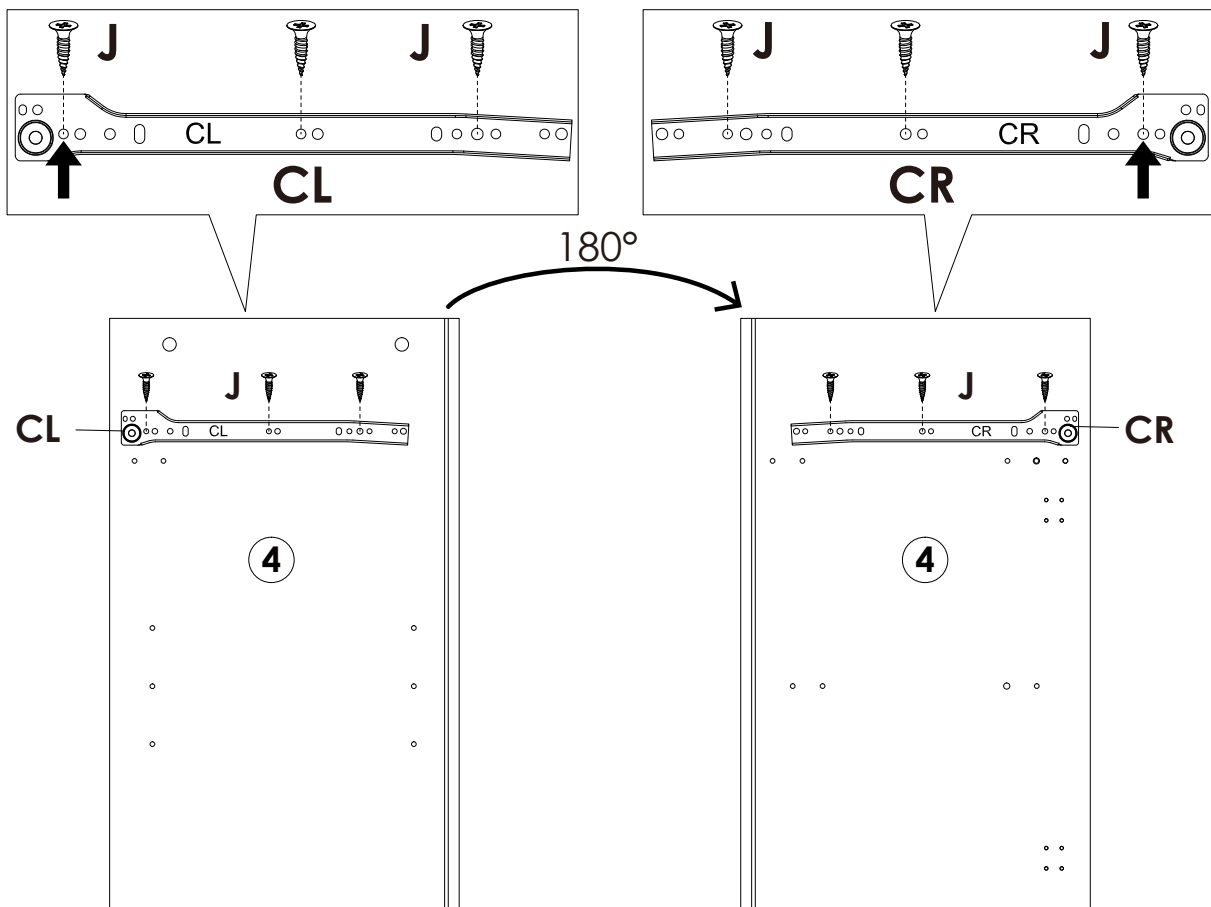
STEP 3

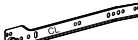

	J x 6PCS
	CL x 1PC
	CR x 1PC

STEP 4

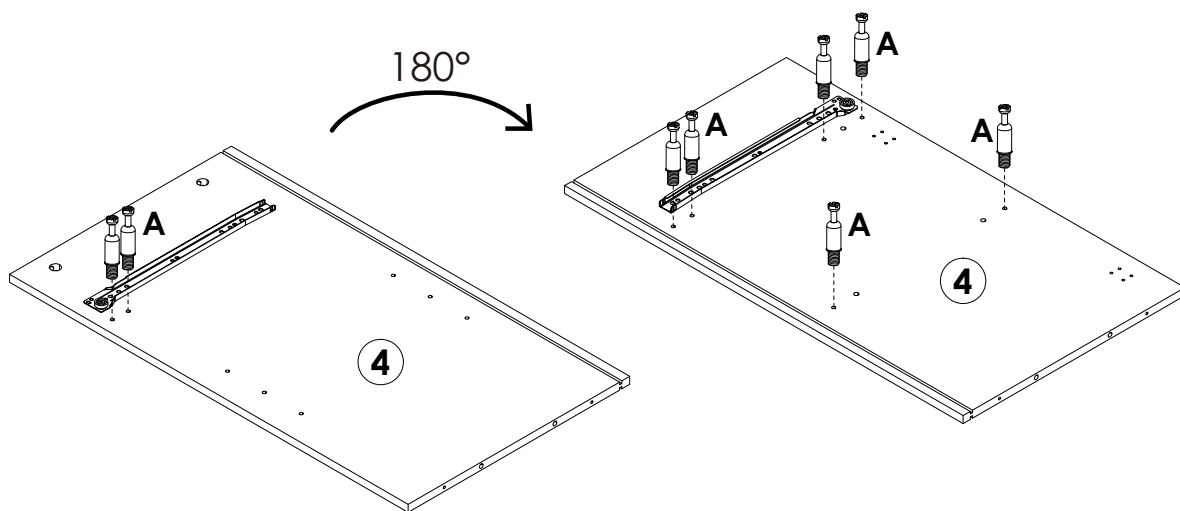

	A x 8PCS
---	----------

Assembly Steps(EN) / Montageschritte(DE)

STEP 5

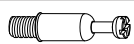
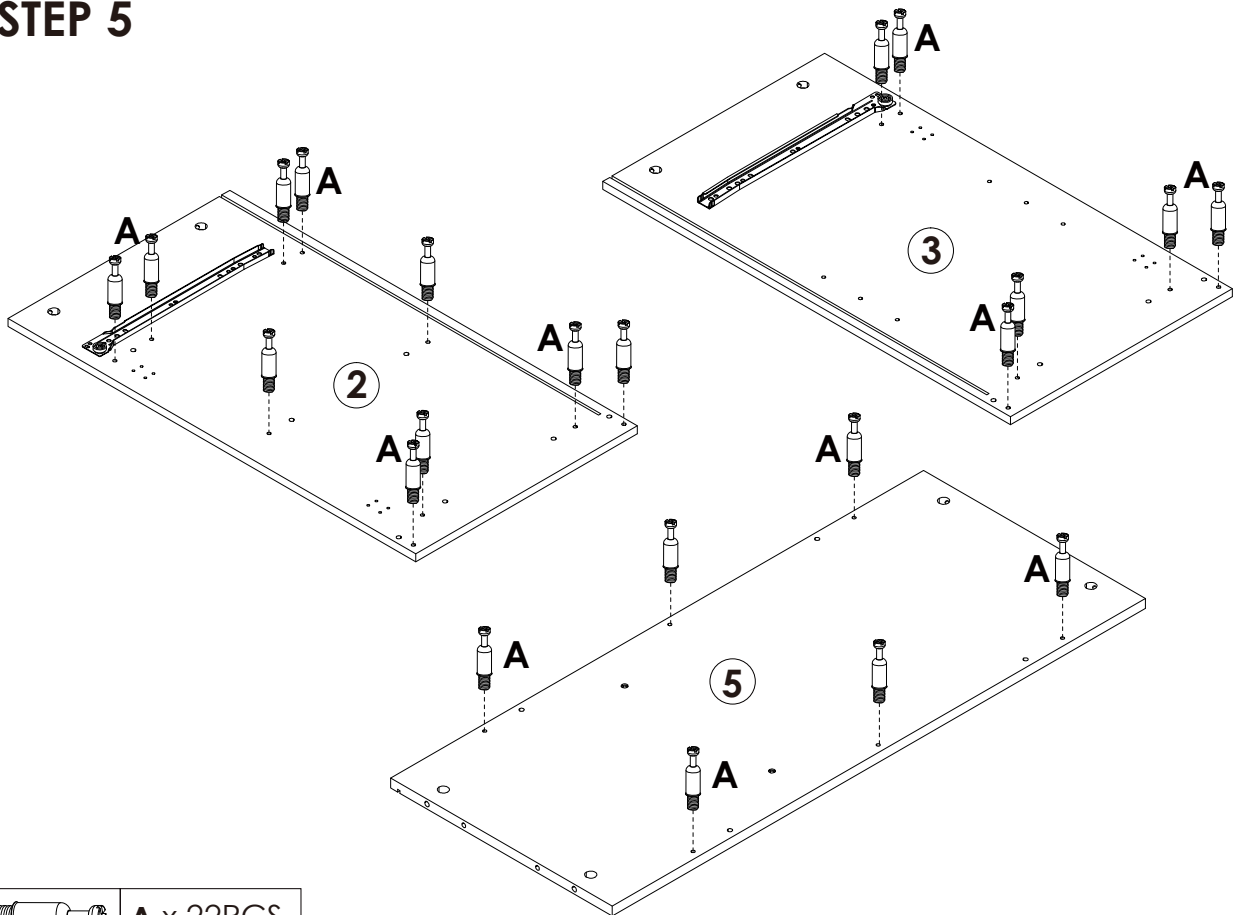

A x 22PCS

STEP 6

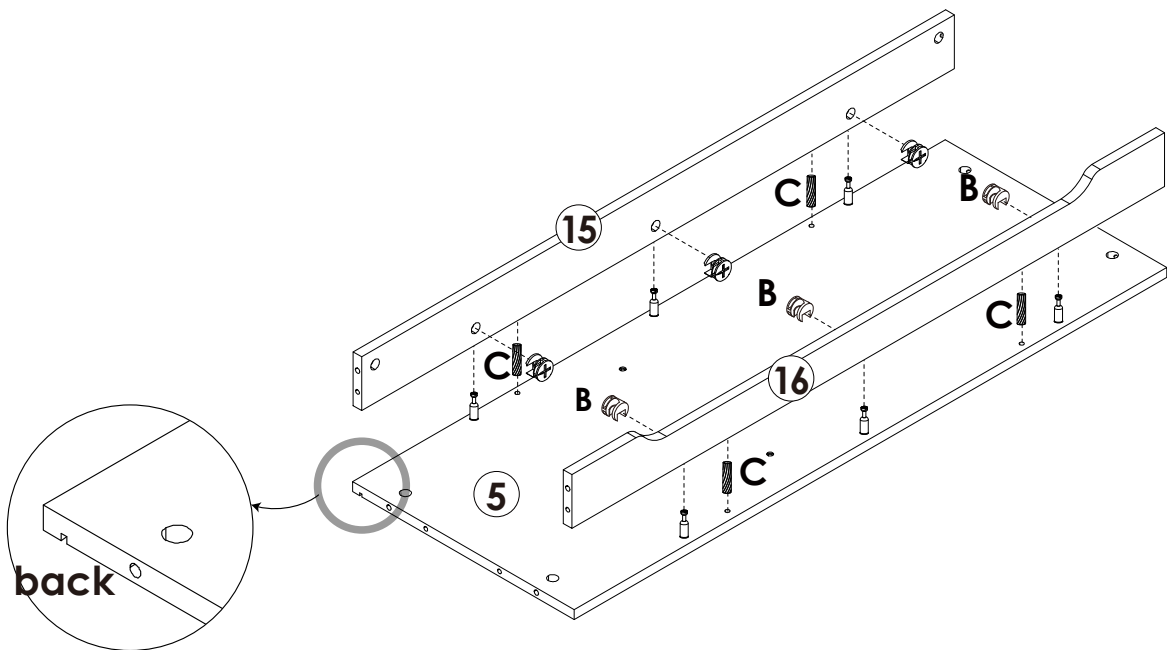

back

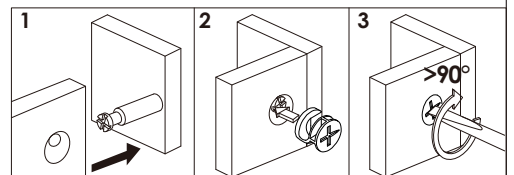

B x 6PCS





C x 4PCS

Assembly Steps(EN) / Montageschritte(DE)

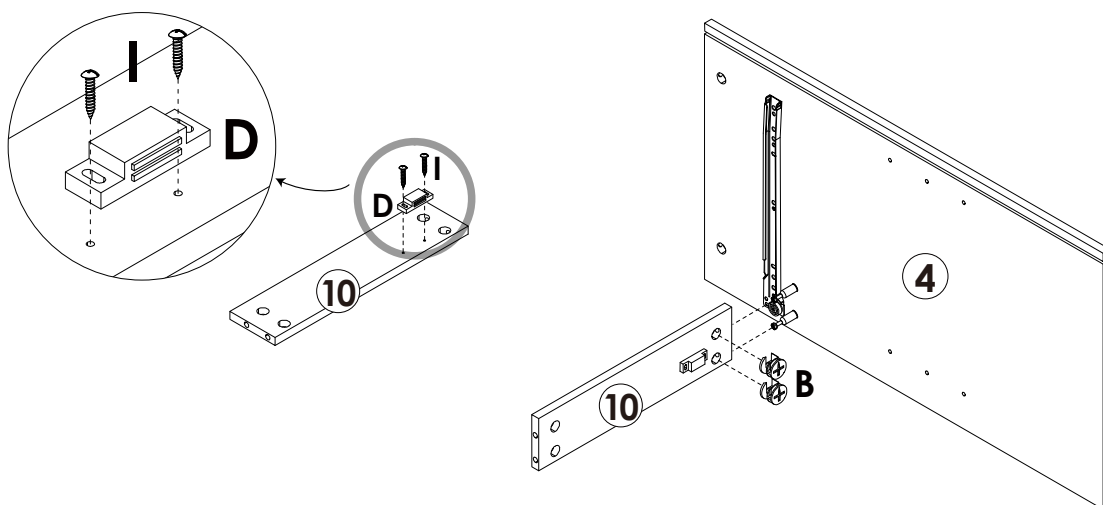
STEP 7



	B x 2PCS
	D x 1PC
	I x 2PCS

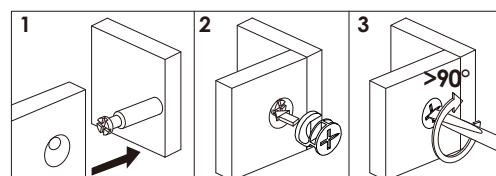

STEP 8

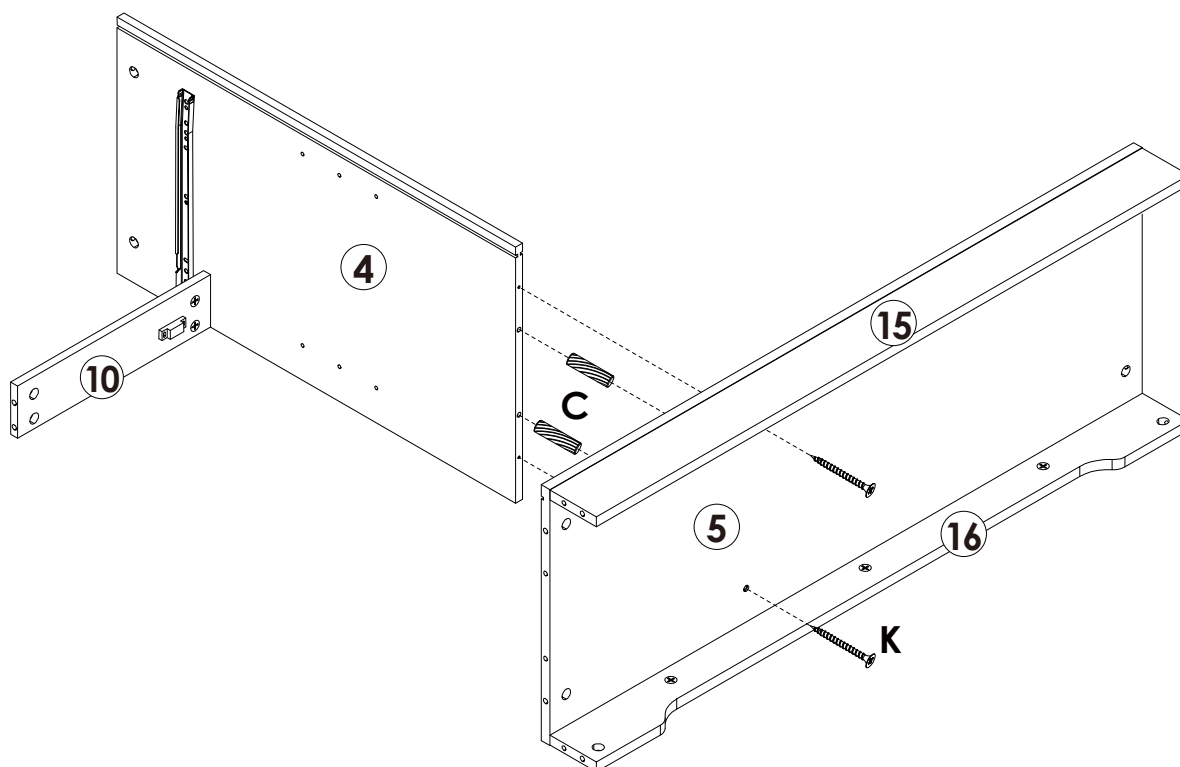

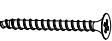

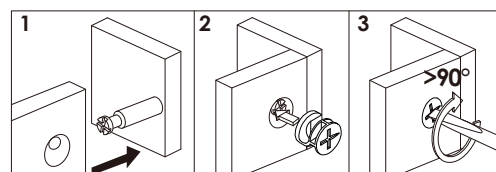
	C x 2PCS
	K x 2PCS



Assembly Steps(EN) / Montageschritte(DE)

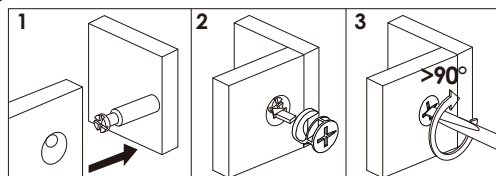
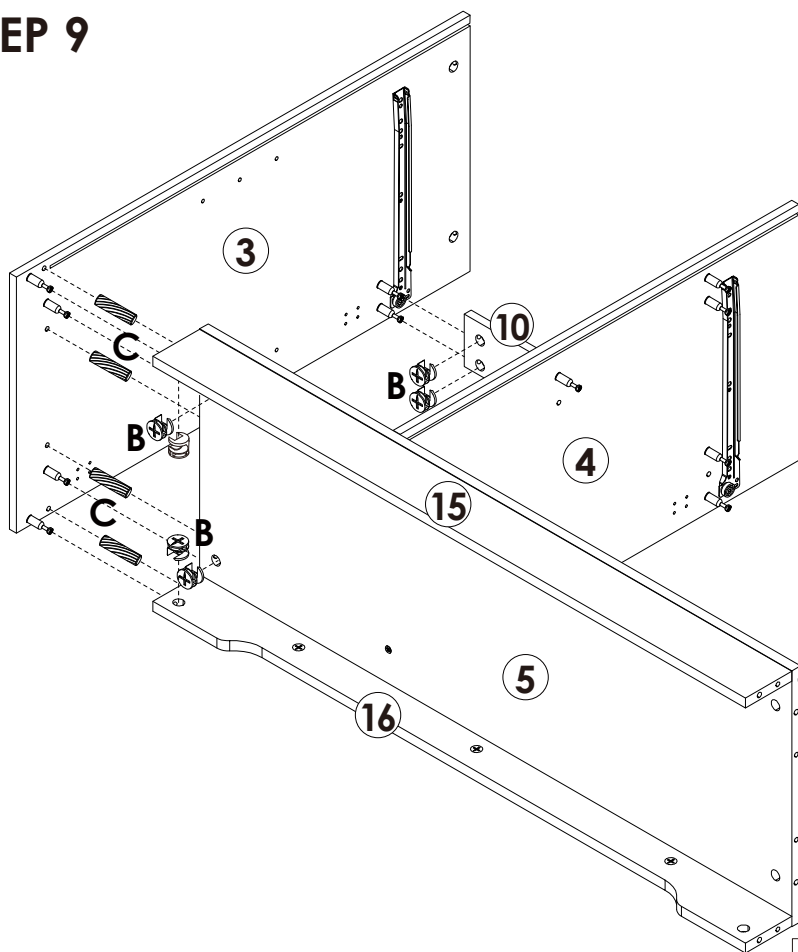

STEP 9

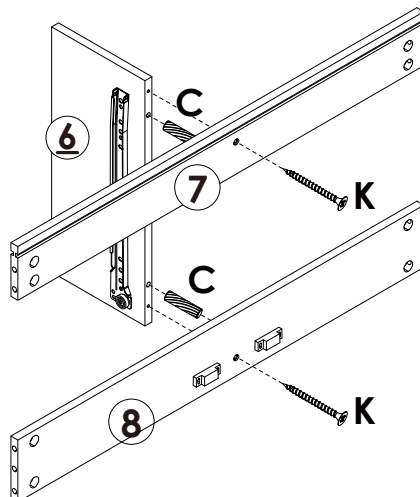
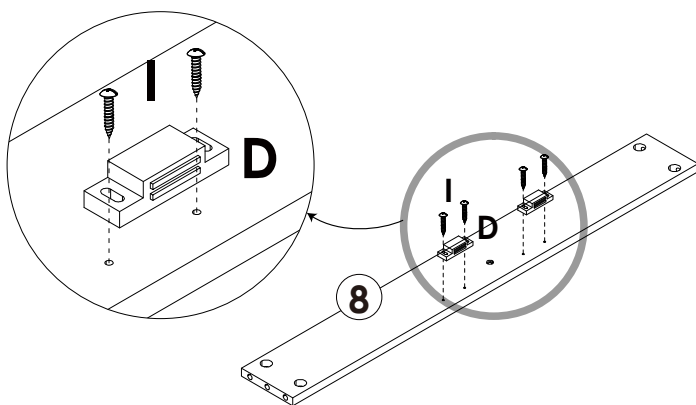

	B x 6PCS
	C x 4PCS

STEP 10



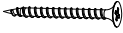

	D x 2PCS
	I x 4PCS
	C x 2PCS
	K x 2PCS

Assembly Steps(EN) / Montageschritte(DE)

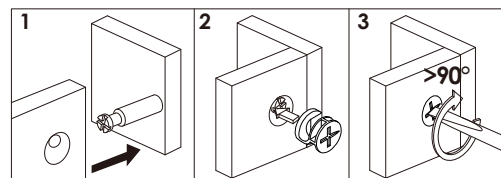
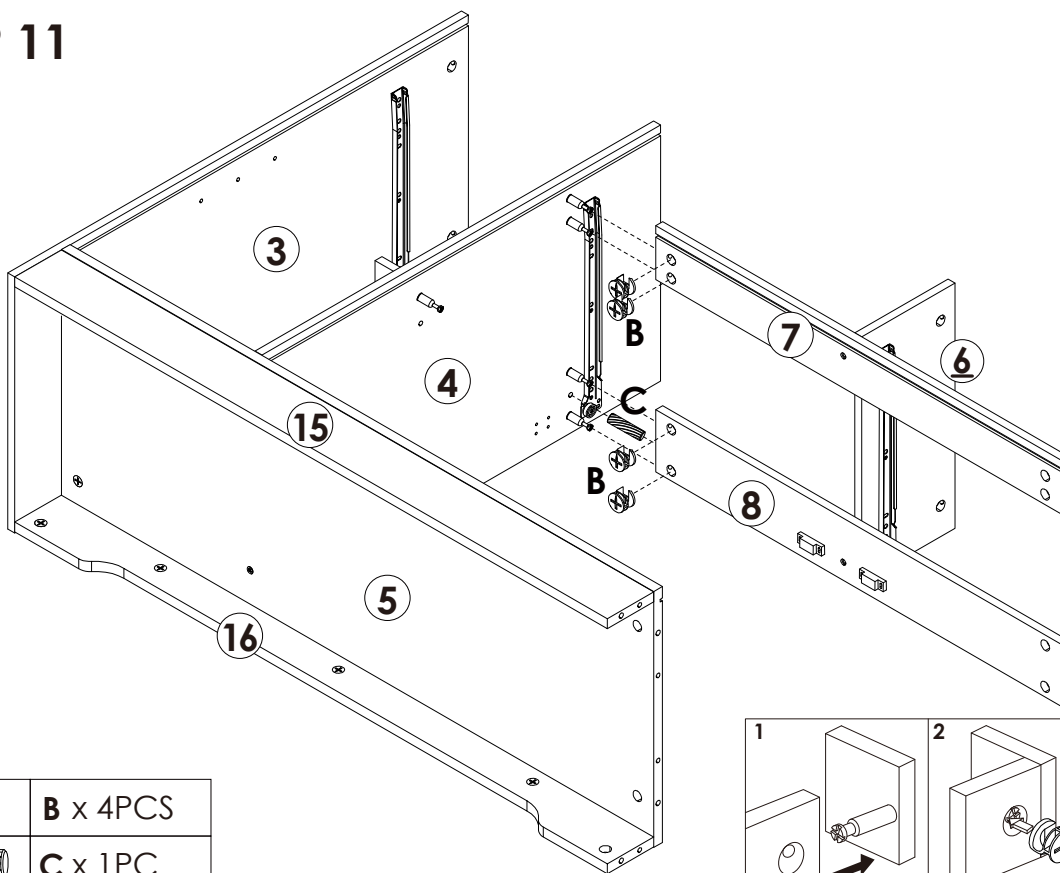

STEP 11

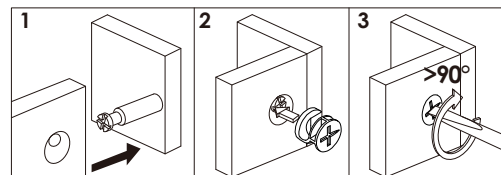
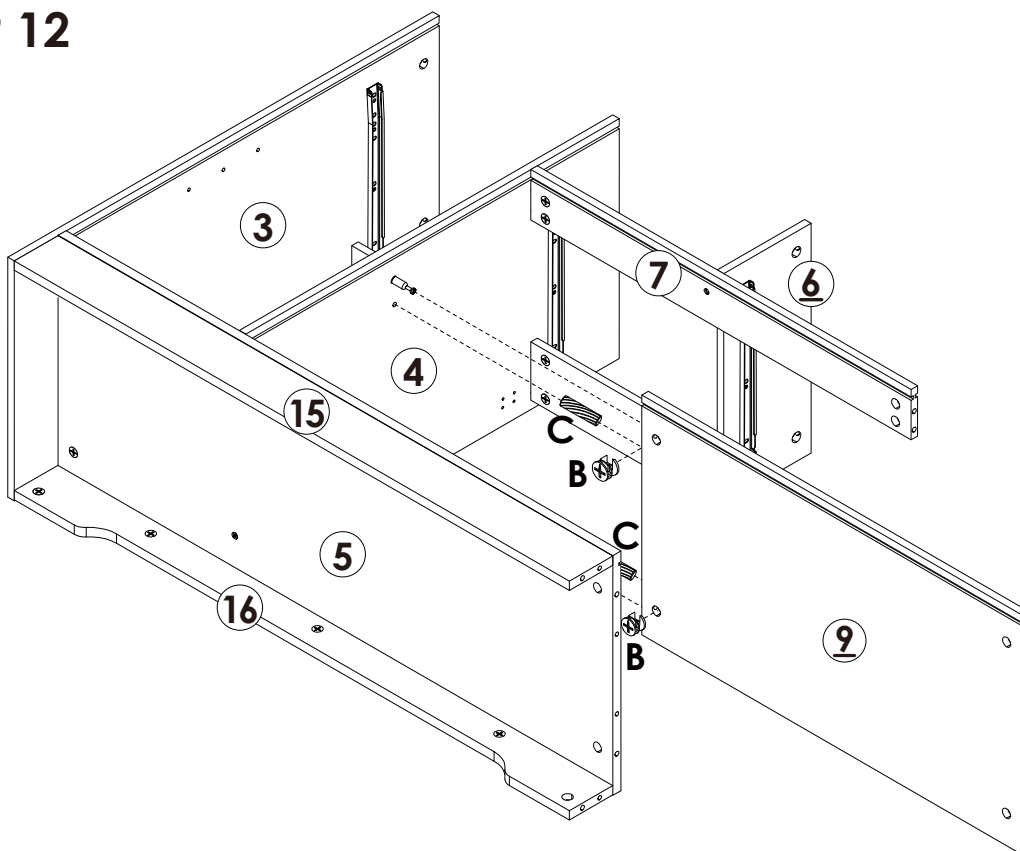

	B x 4PCS
	C x 1PC

STEP 12



	B x 2PCS
	C x 2PCS

Assembly Steps(EN) / Montageschritte(DE)

STEP 13

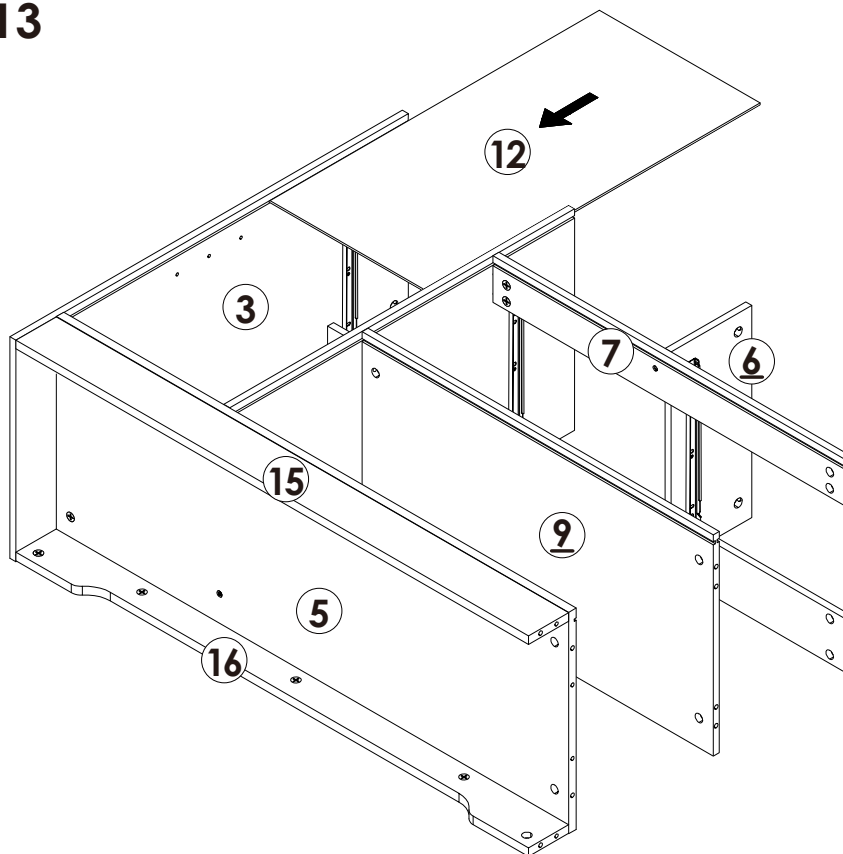

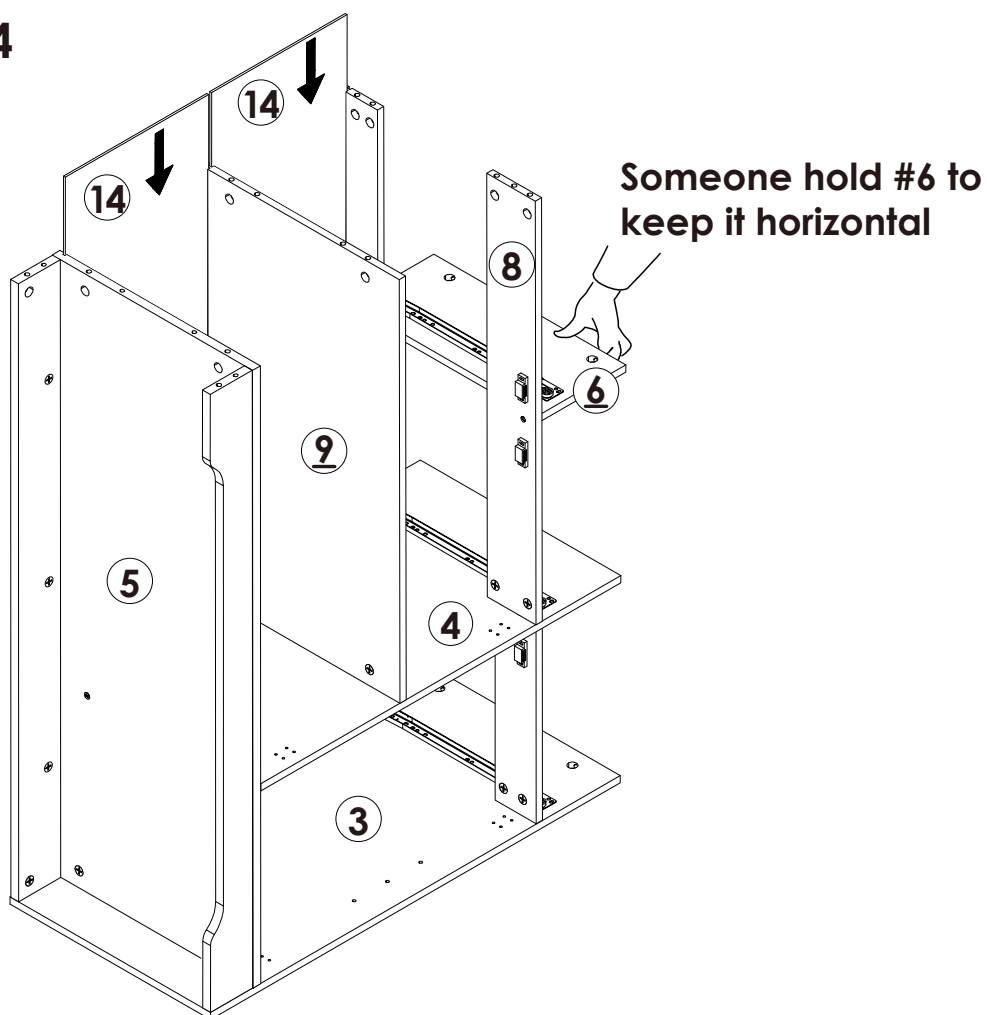

STEP 14

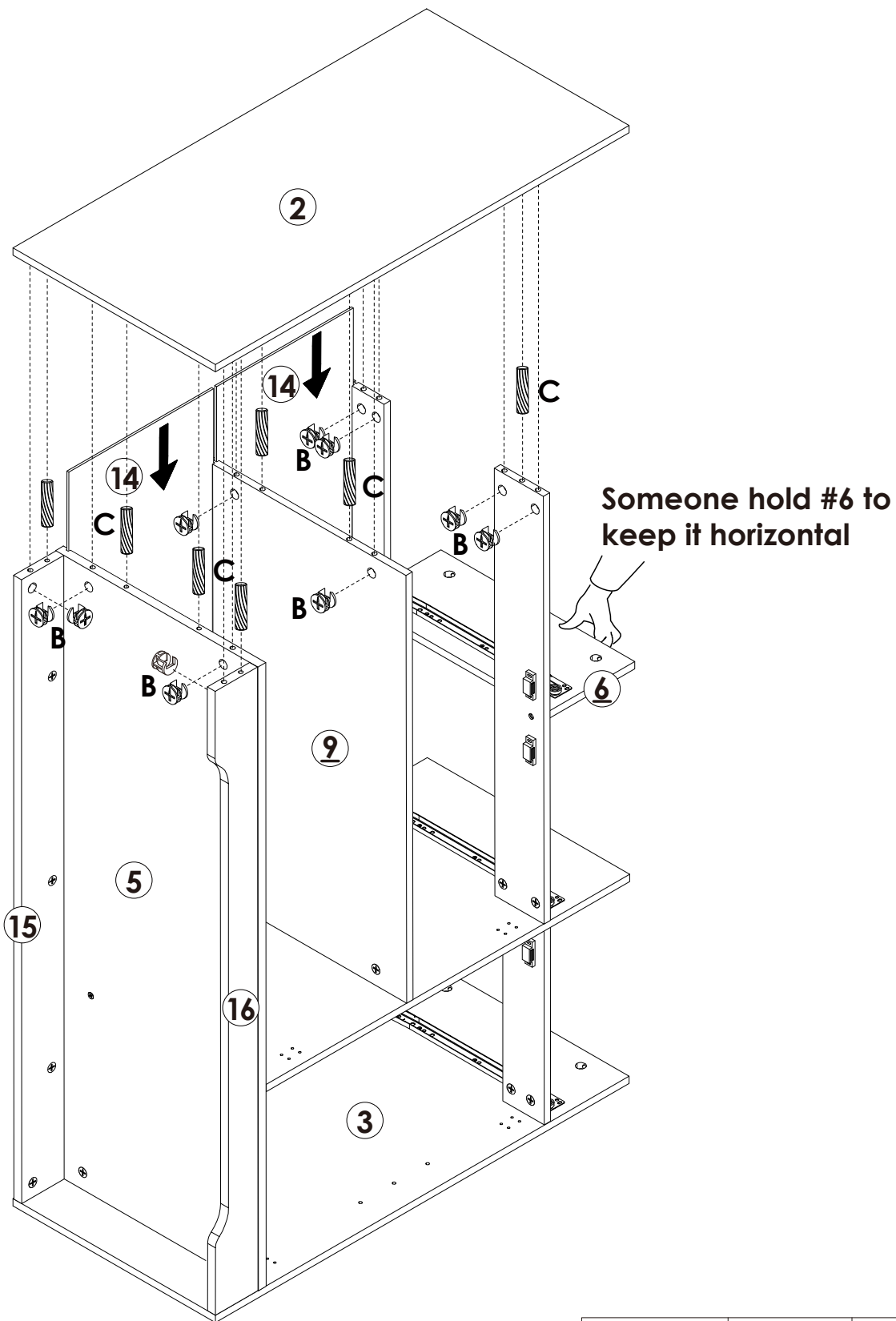

Assembly Steps(EN) / Montageschritte(DE)

STEP 15



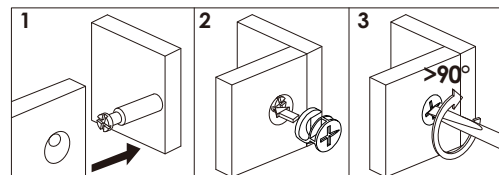

	B x 10PCS
	C x 7PCS



Assembly Steps(EN) / Montageschritte(DE)

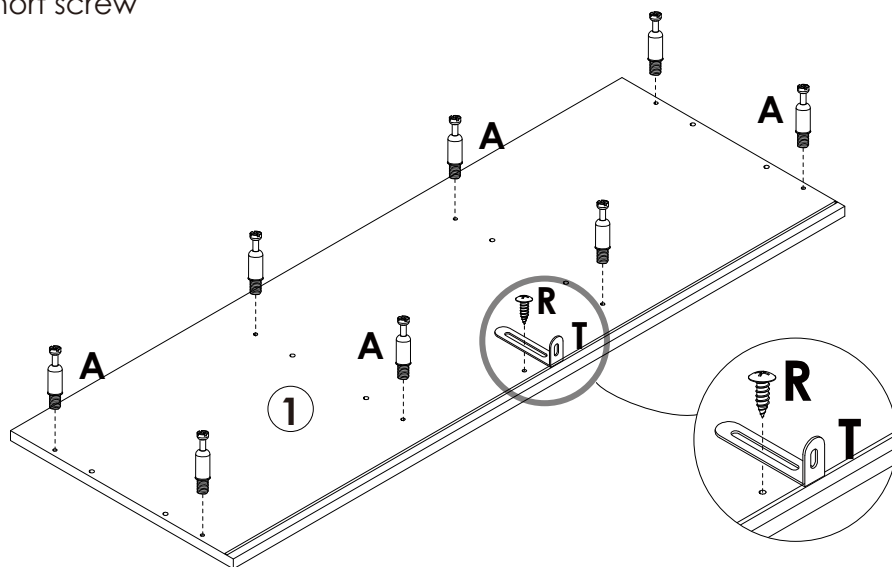

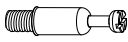
STEP 16 Lock the long side of the "T" L-shaped metal plate to the ① board with the "R" short screw

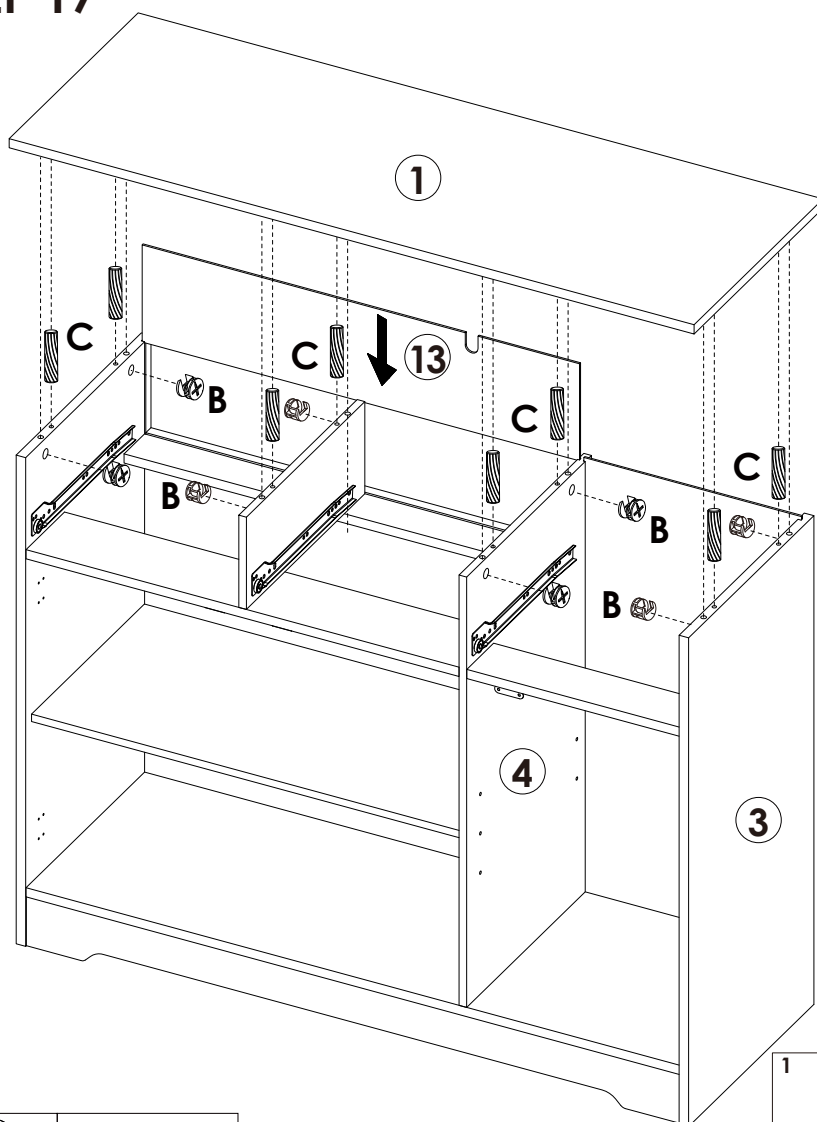

	A x 8PCS
	R x 1PC
	T x 1PC

STEP 17



	B x 8PCS
	C x 8PCS

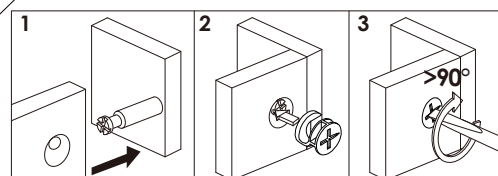

Assembly Steps(EN) / Montageschritte(DE)

STEP 18

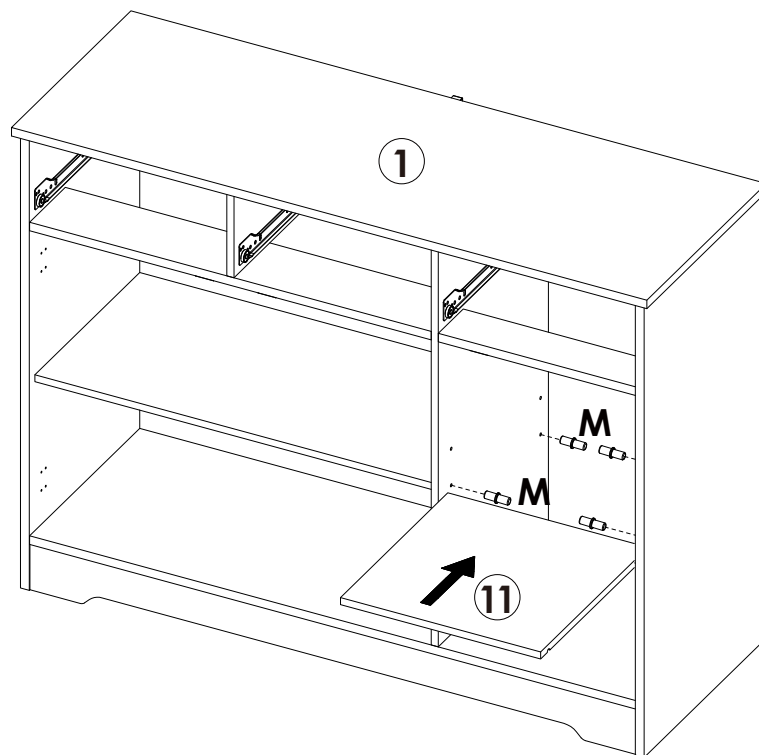

M x 4PCS

STEP 19

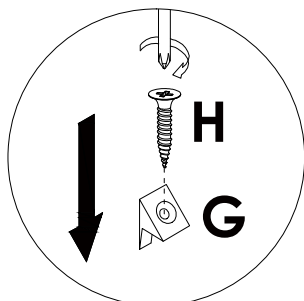
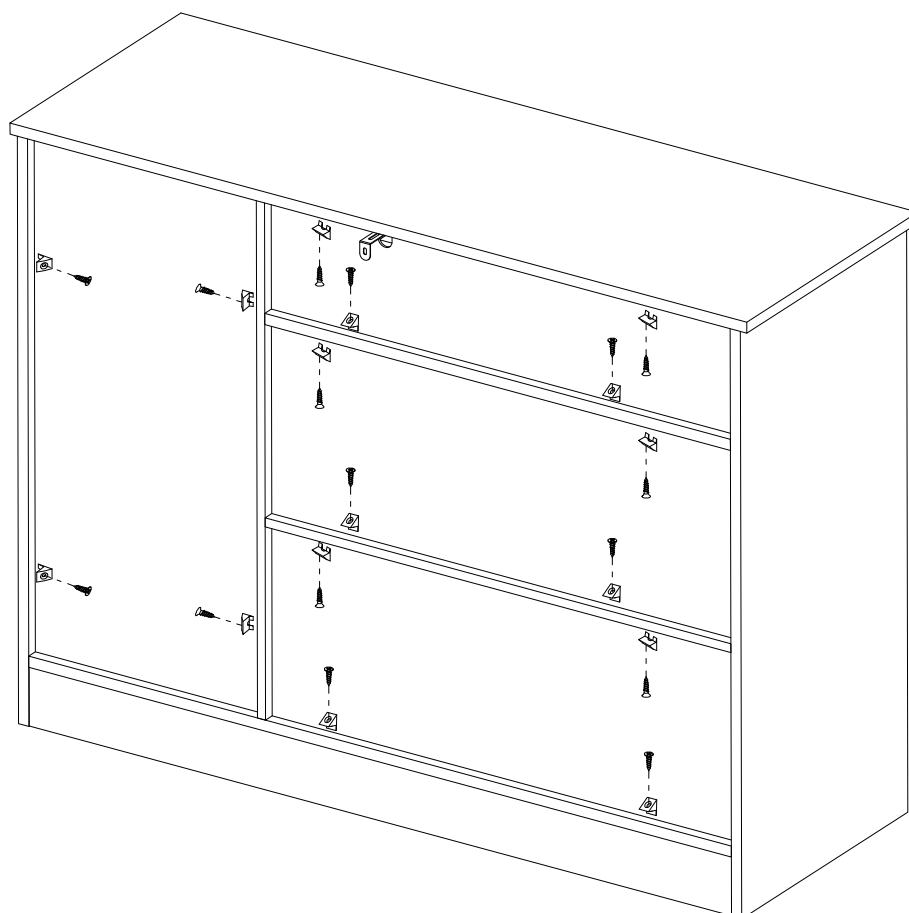

G x 16PCS

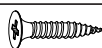

H x 16PCS

Assembly Steps(EN) / Montageschritte(DE)

STEP 20 Drill a hole on the wall at the required position for anti-falling device installation.

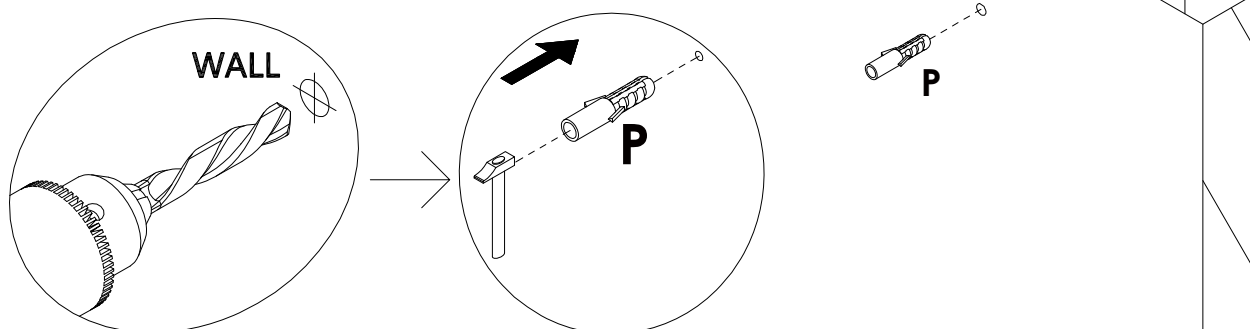

 P x 1PC

STEP 21 Move the cabinet to the required position, use the "L" long screw to fix the cabinet to the wall.

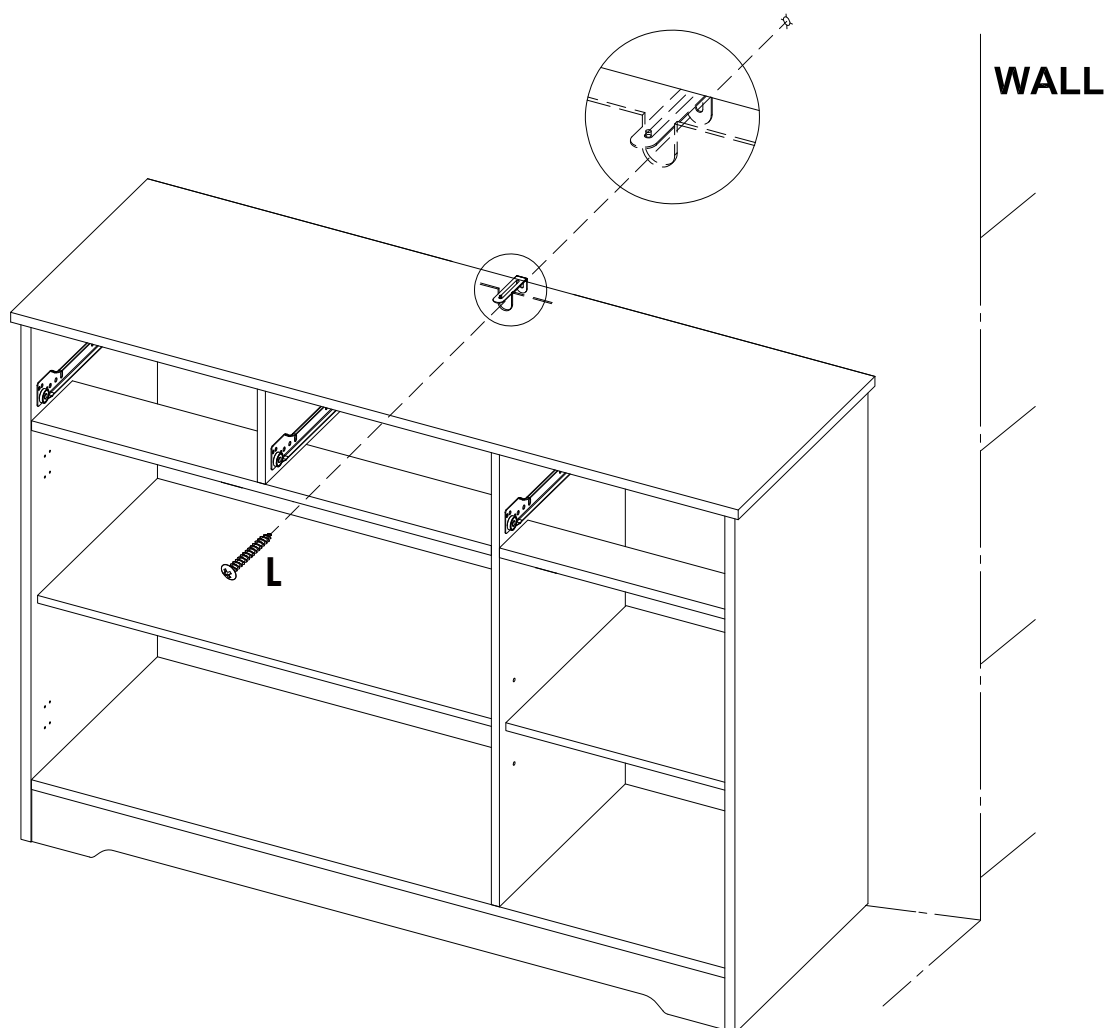

 L x 1PC

Assembly Steps(EN) / Montageschritte(DE)

STEP 22

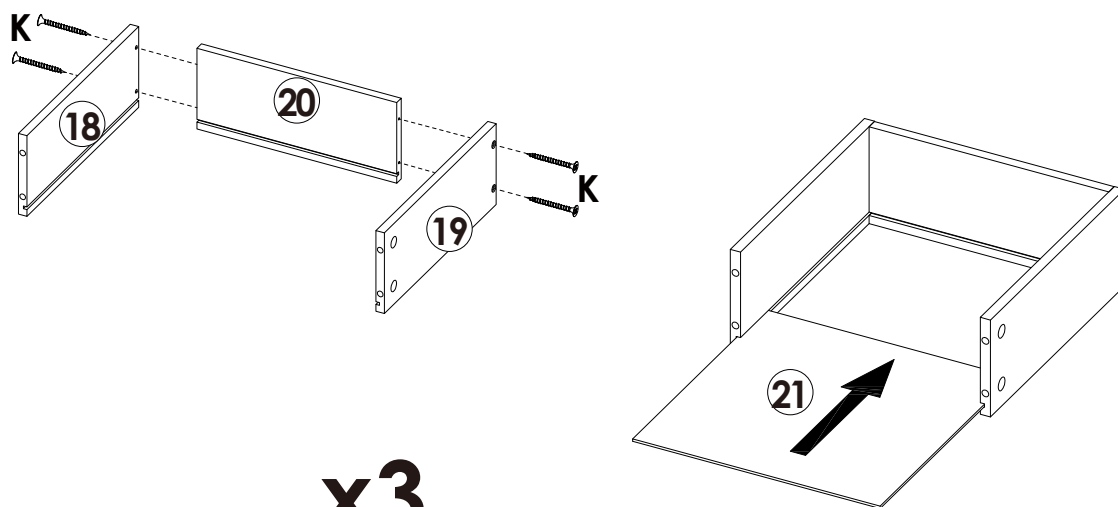

x3

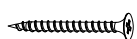

K x 12PCS

STEP 23

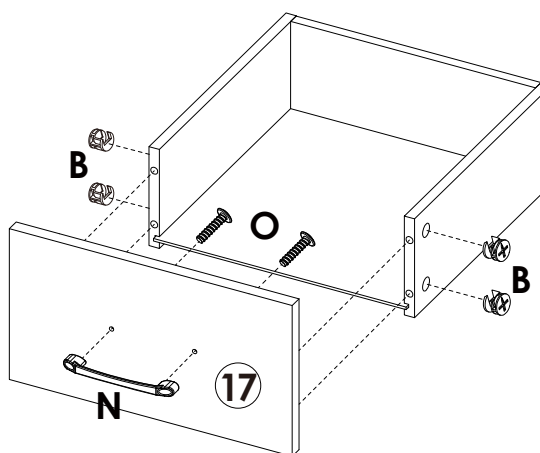
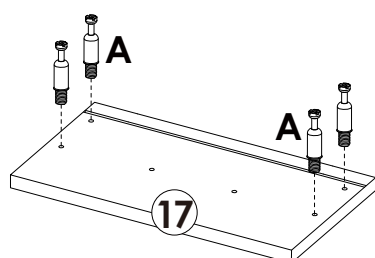

x3

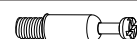

A x 12PCS



B x 12PCS



N x 3PCS





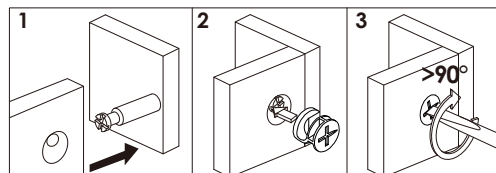

O x 6PCS

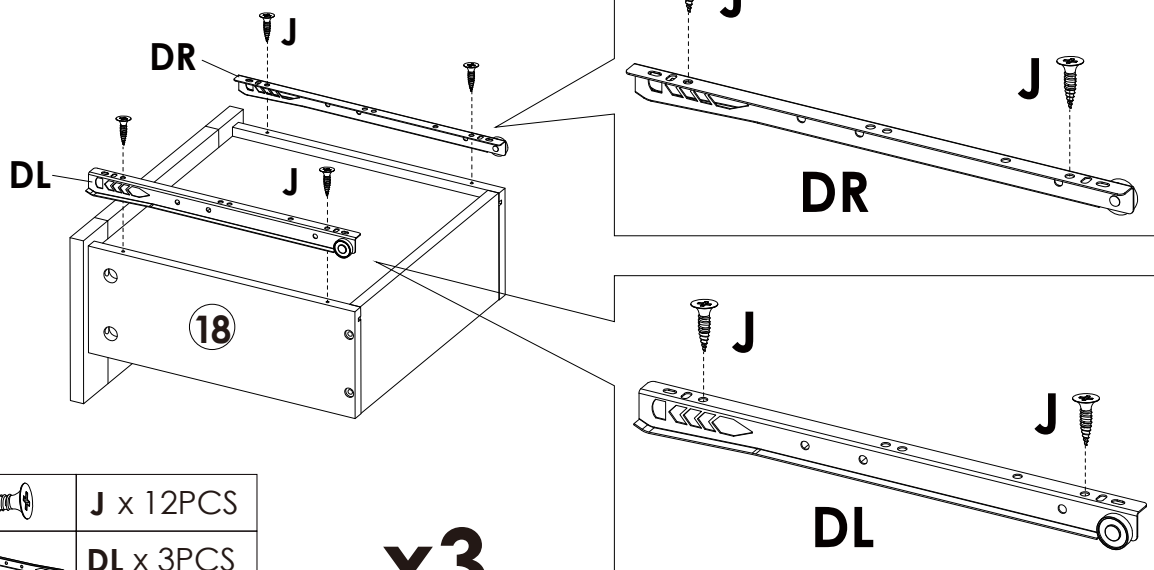

Assembly Steps(EN) / Montageschritte(DE)

STEP 24







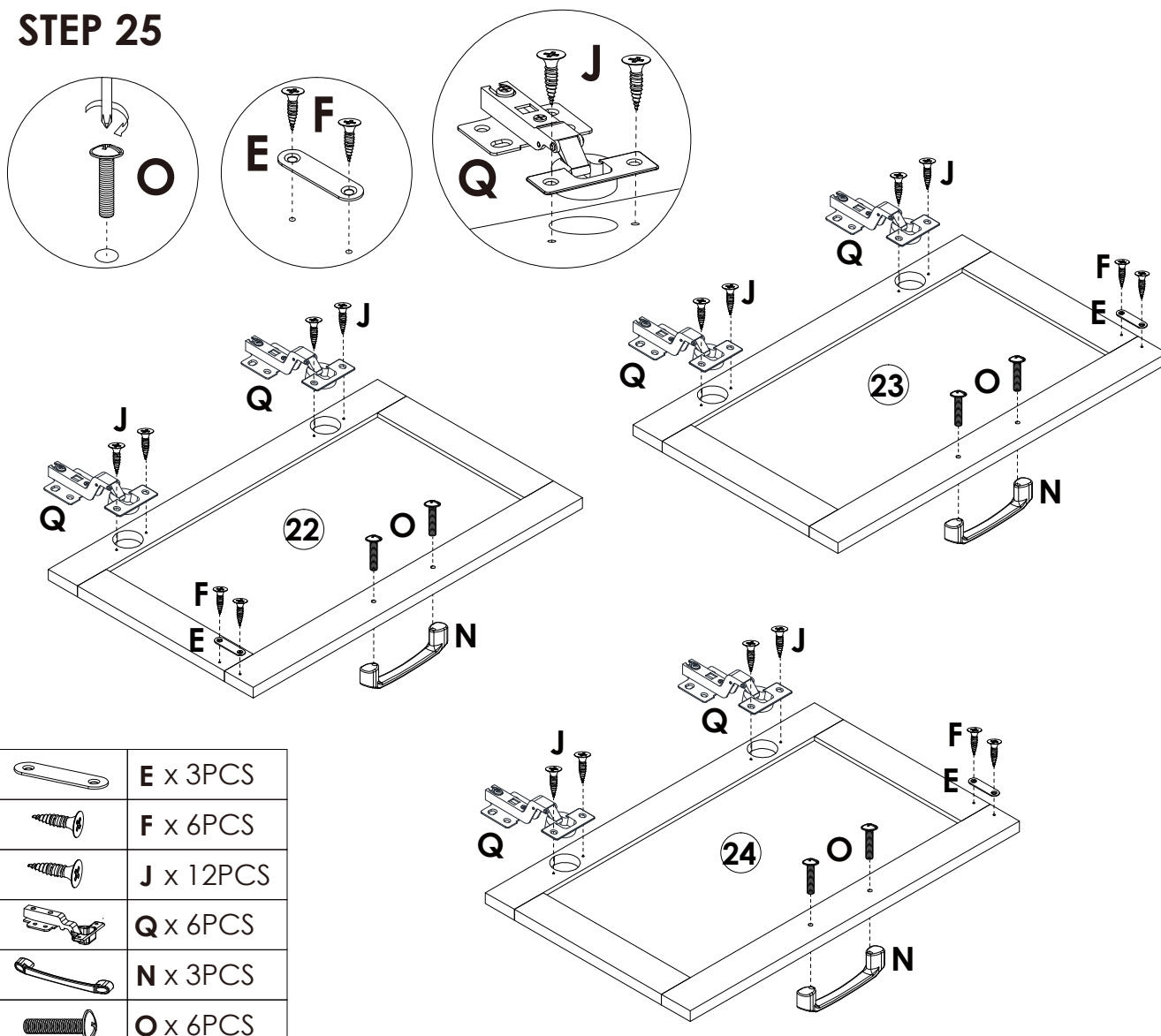

	J x 12PCS
	DL x 3PCS
	DR x 3PCS

x3

STEP 25



	E x 3PCS
	F x 6PCS
	J x 12PCS
	Q x 6PCS
	N x 3PCS
	O x 6PCS

Assembly Steps(EN) / Montageschritte(DE)

STEP 26

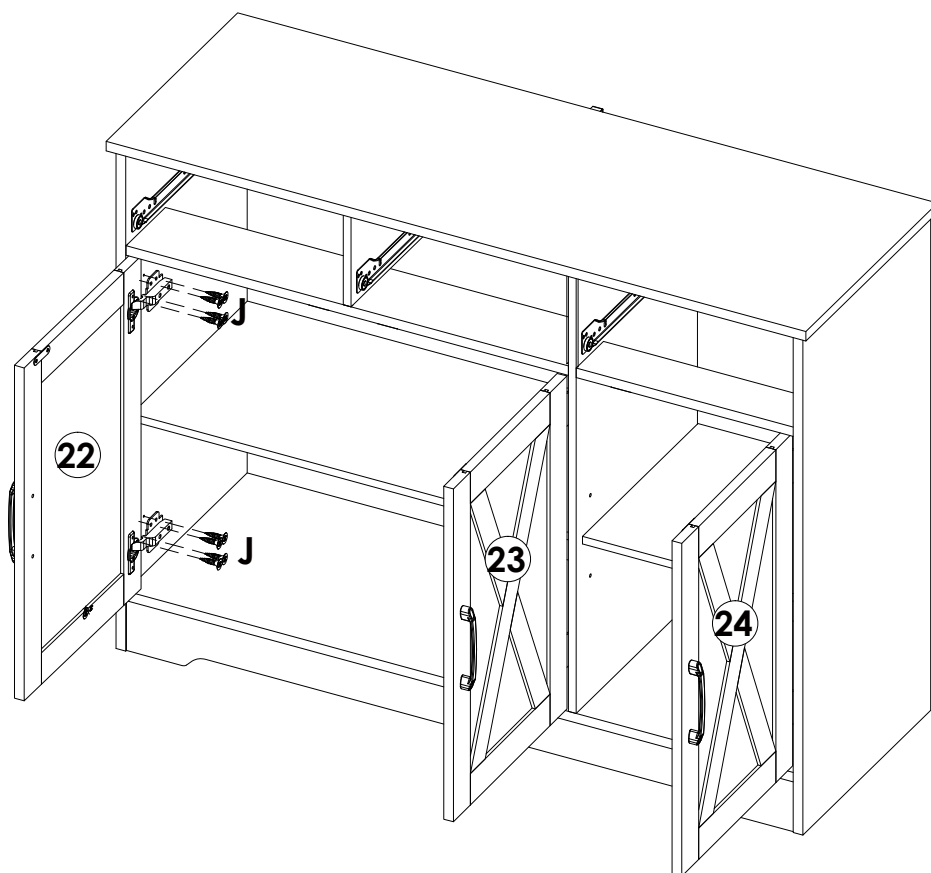
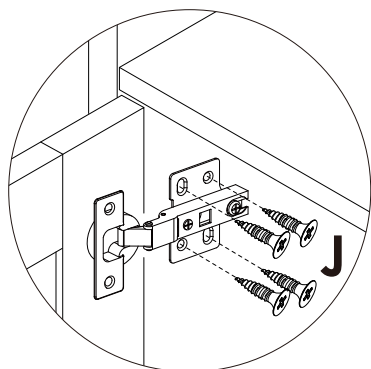

J x 24PCS

STEP 27

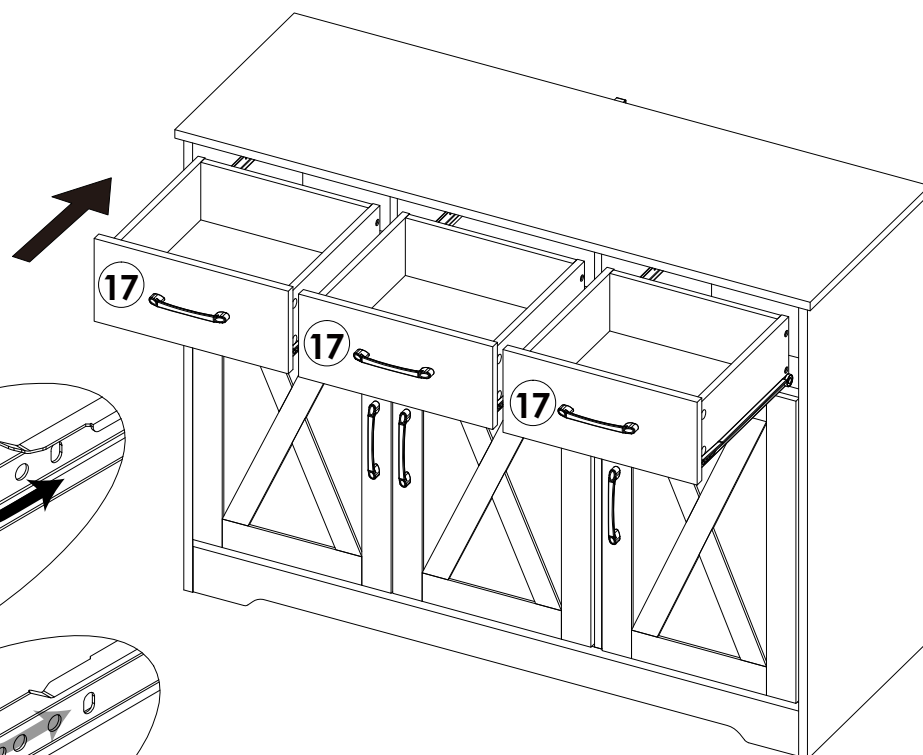
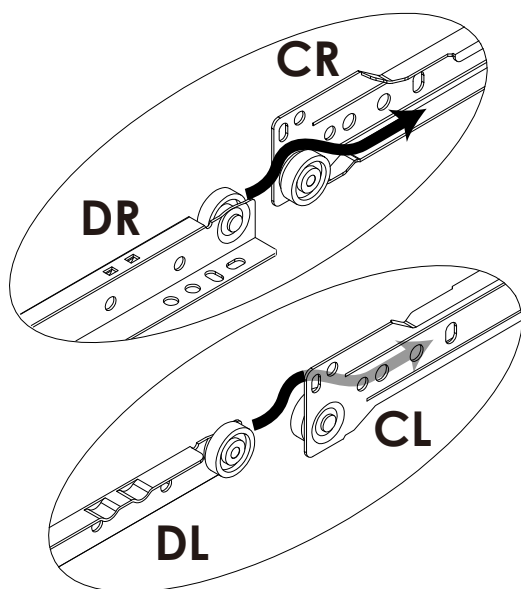

The ways to adjust the door

- Before adjusting the hinge, please check whether the cabinet is skewed.
- If the skew can not be repaired, please remove the anti-tipping device first, then adjust the cabinet to vertical position.
- Please adjust the hinge with the door open.
- Please operate it with more than 2 people, one person holds the door and the other one adjusts the screw.

Components Name

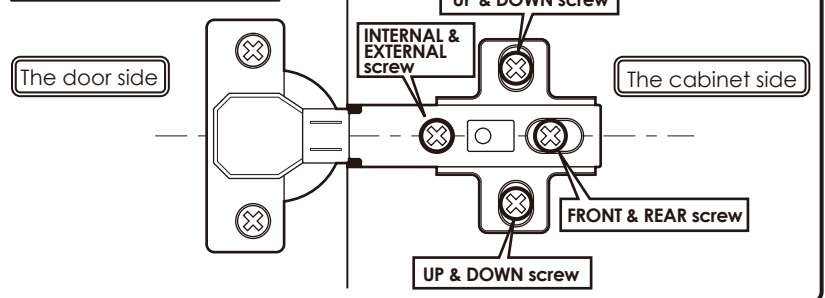

When door is crooked



Please take the following steps to adjust first.

1 Rotate the "front and rear screws" to the left

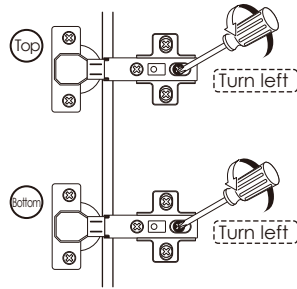

2 Push the door to the cabinet

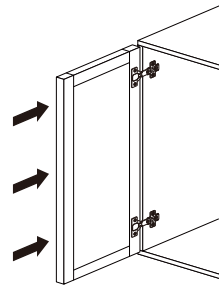

3 Rotate the "front and rear screws" to the right

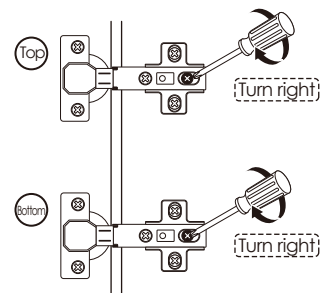

※ After adjusting the "front and rear screw", the door still does not change, please turn the "internal & external screw" to the right slightly.

When door is leaning

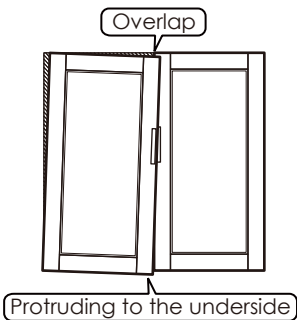

1 Turn "internal & external screw" to the left can make the top of the door tilted outward.

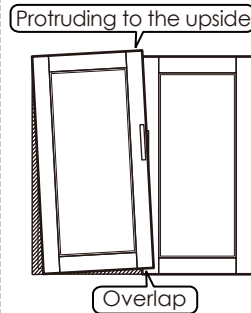
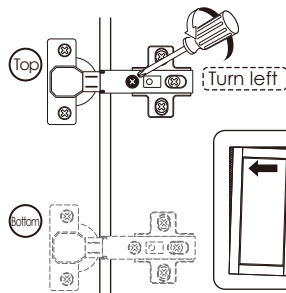

1 Turn "internal & external screw" to the left can make the bottom of the door tilted outward.

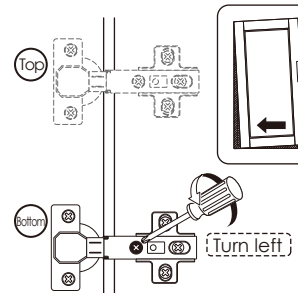

When 2 doors are not tight

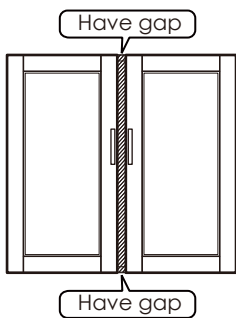

1 Turn "internal & external screw" to the right can make the door approach inside. Please adjust the doors little by little.

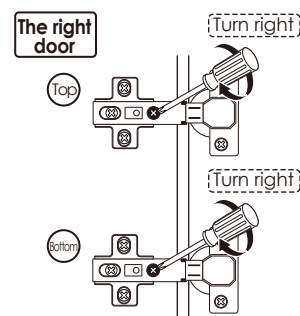
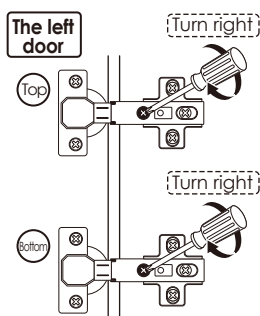

※ If the 2 doors are overlap, please turn the "internal & external screw" to the left.

When the door is higher on top

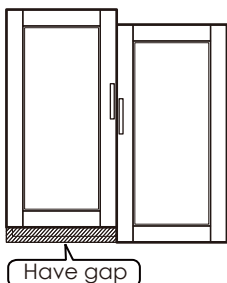

1 Turn "up & down screw" to the left

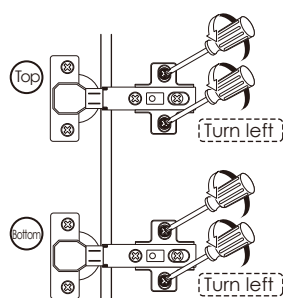

2 Lower the door's height so that 2 doors are of the same height.

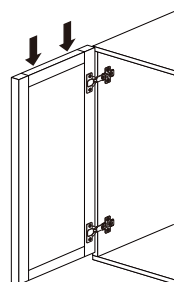

3 Turn "up & down screw" to the right

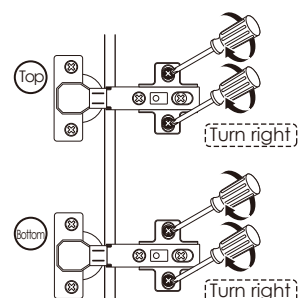

※ If the door is lower on bottom, please lift up the left door slightly on step 2



WARNING



Children have died from furniture tipover. To reduce the risk of furniture tipover:

- **ALWAYS** install tipover restraint provided.
- **NEVER** allow children to stand, climb or hang on drawers, doors, or shelves.
- **NEVER** open more than one drawer at a time.
- **Place heaviest items in the lowest drawers.**