

WARNING!!



Children have died from furniture tipover. Tip restraints have been included with this product; you must install the tip restraints according to these instructions in order to minimize the risk of furniture tipping. If you have any questions about this product or the tip restraint, please send us an email at tip_restraint_help@Noblehousefurniture.com

NEVER allow children to climb or hang on furniture, including drawers or cabinet doors.

In addition to installing the restrains, to help prevent tip-over

1. For use with televisions weighing 31.3 lbs or fewer. Use with heavier televisions may result in instability causing tip-over resulting in death or serious injury. **NEVER** use with CRT televisions

2. Do not stand on the product

 WARNING	
	<p>Children have died from furniture tipover. To reduce the risk of furniture tipover:</p> <ul style="list-style-type: none">• ALWAYS install tipover restraint provided.• For use with televisions weighing 31.3 lbs or fewer. Use with heavier televisions may result in instability causing tipover resulting in death or serious injury. NEVER use with CRT TVs.• NEVER allow children to stand, climb or hang on drawers, doors, or shelves.• NEVER open more than one drawer at a time.• Place heaviest items in the lowest drawers.• Do not defeat or remove the drawer interlock system.
	<p><i>This is a permanent label. Do not remove!</i></p>





Assembly Instructions

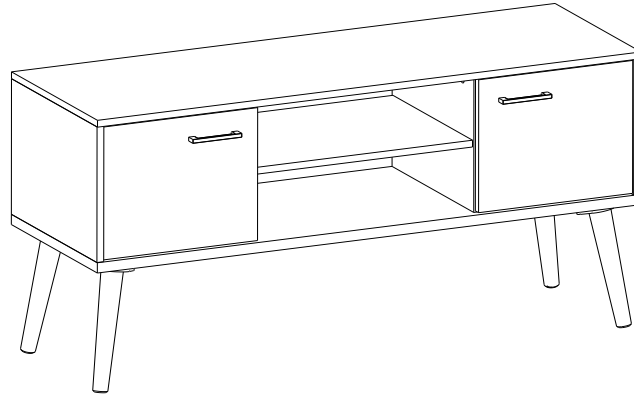

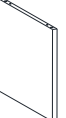

Caution : You must read this before you proceed

TV CABINET



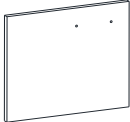
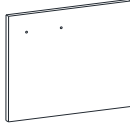
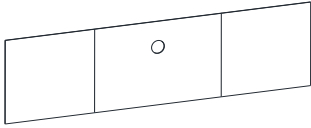
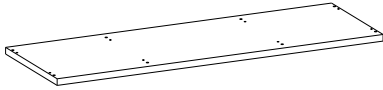

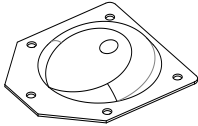











Parts List

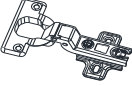

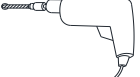

Label	Picture	Description	QTY
A		Top Panel	1
B		Left Side Panel	1
C		Right Side Panel	1
D		Left Center Panel	1
E		Right Center Panel	1

F		Left Door Panel	1
G		Right Door Panel	1
H		Back Panel	1
I		Bottom Panel	1
J		Shelf Panel	1
K		Handle	2
L		Leg Support	4
M		Leg (with PVC Nail Leg)	4

Hardware

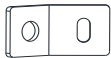
Label	Picture	Description	QTY
①		Cam Lock	9
②		Cam Bolt	9
③		Cam Cap	9
④		Positioning Dowel (φ8*30mm)	17
⑤		Cap Wood Screw (M6*60mm)	9
⑥		Screw (M3.5*16mm)	17
⑦		Screw (M4*20mm)	21
⑧		Screw (M4*25mm)	5
⑨		Connector	4
⑩		Nail	21
⑪		Metal Shelf Support	5
⑫		Allen Key	1
⑬		Screwdriver (not provided)	1
⑭		Hammer (not provided)	1
⑮		Power Drill (not provided)	1

Cabinet Restraint Device Hardware

⑩①⑥		Metal Bracket	4
⑩①⑦		Wall Plug	2
⑩①⑧		Wall Plug Screw	2
⑩①⑨		Pan Head Screw	2
⑩②①		Cabinet Restraint Strap	2

Assembly Preparation

Before Beginning Assembly:

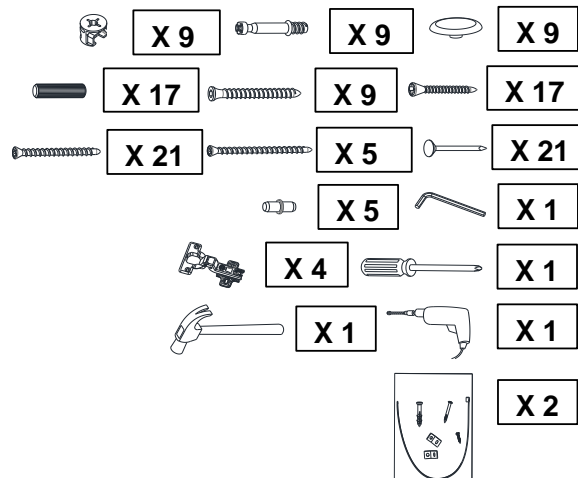
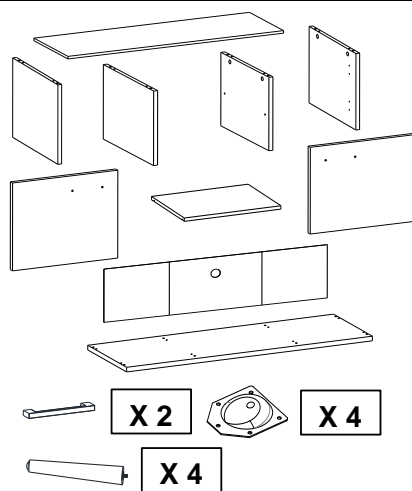

- Read instructions, cover to cover-



- Have 2 adults on hand for assembly-



- Do not assemble on flooring or carpet-



- Assemble on a clean non-marring surface (packing foam)-



- Save all packaging until finished-

Assembly Steps

Overview

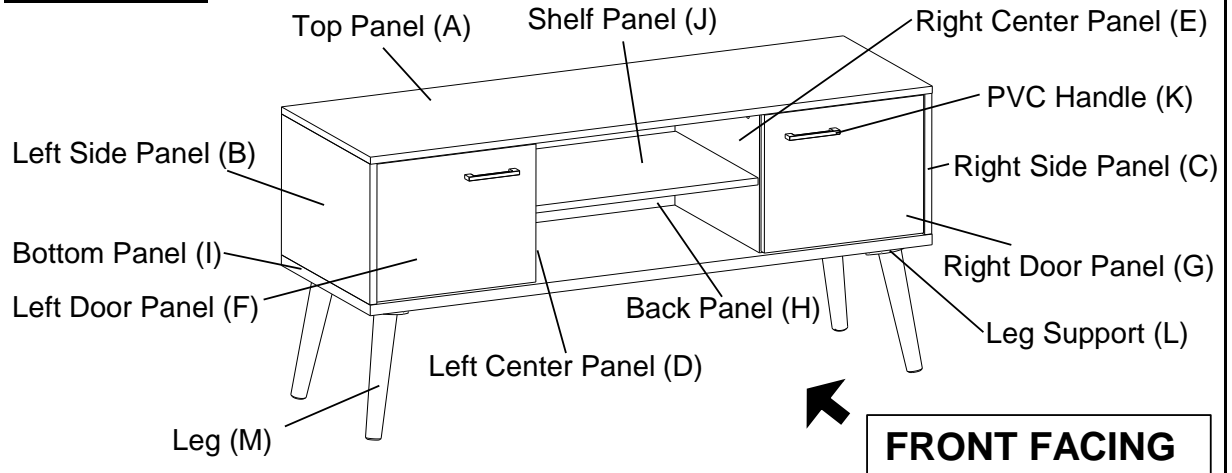

This TV Cabinet has multiple parts and may require up to 60 minutes to assemble. To give you an overview of the TV Cabinet parts, the above picture is to help you put the various parts into perspective. Please read through the instructions below to familiarise yourself with the parts and steps before assembly.

Step 1

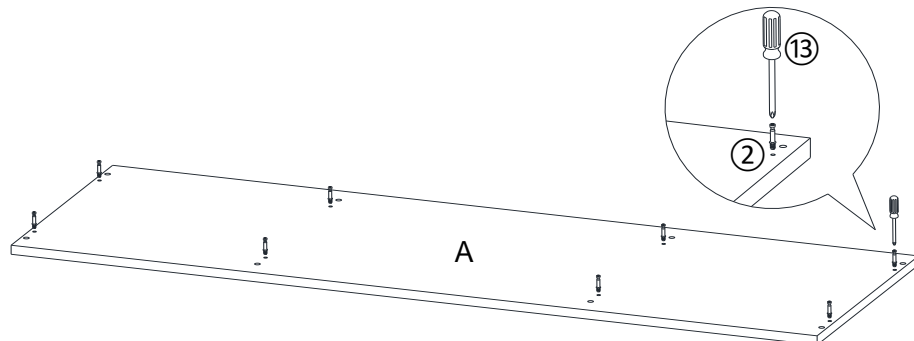

Unpack and place all parts on a clean, non-marring surface. Attach Cam Bolts(②) to mounting positions on Top Panel(A) with Screwdriver(⑬).

Step 2

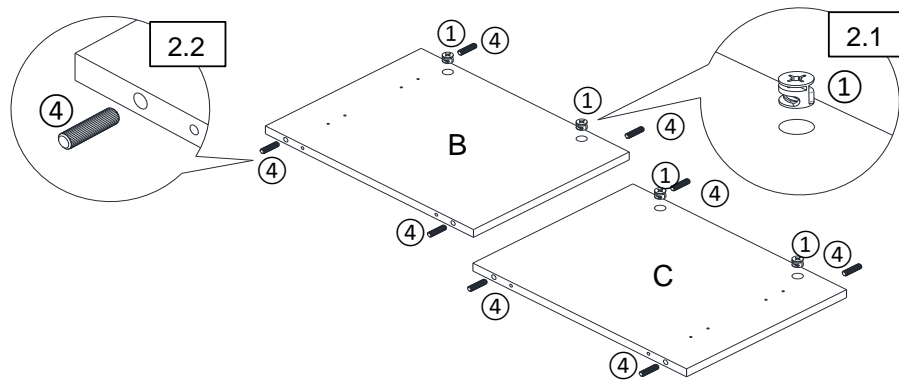

2.1) Insert Cam Locks((1)) into mounting positions on Left Side Panel(B) by hand.

2.2) Insert Positioning Dowels((4)) into mounting positions on Left Side Panel(B) by hand.

2.3) Repeat the same assembly process with the Right Side Panel(C).

Step 3

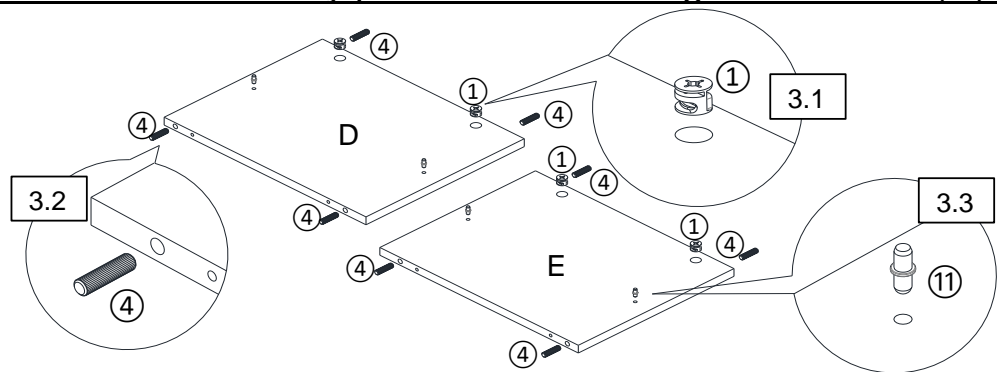

3.1) Insert Cam Locks((1)) into mounting positions on Left Center Panel(D) by hand.

3.2) Insert Positioning Dowels((4)) into mounting positions on Left Center Panel(D) by hand.

3.3) Insert Metal Shelf Supports((11)) into mounting positions on Left Center Panel(D) by hand.

3.4) Repeat the same assembly process with the Right Center Panel(E).

Step 4

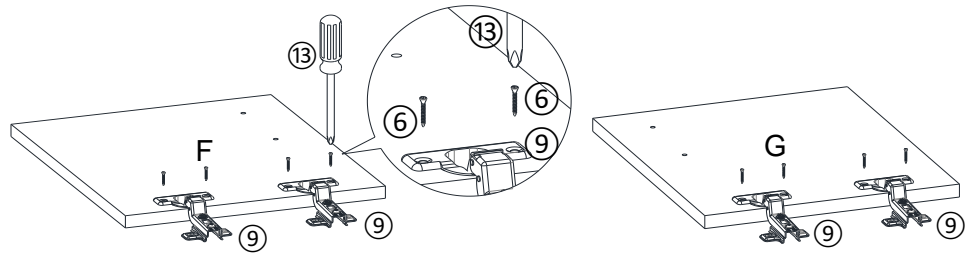

Attach Connectors((9)) to Left Door Panel(F) and Right Door Panel(G) with Screws((6)) using Screwdriver((13)).

Tighten the Screws fully in a sequential manner.

Note: There are pre-existing mounting positions on Left Door Panel(F) and Right Door Panel(G) to fix the Connectors((9)).

Step 5

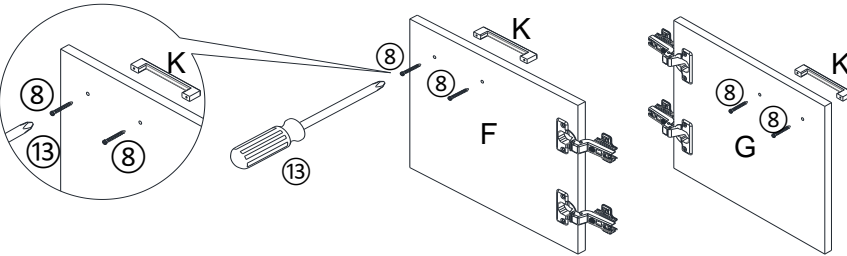

Attach Handles(K) to Left Door Panel(F) and Right Door Panel(G) with Screws((8)) using Screwdriver((13)).

Tighten the Screws fully in a sequential manner.

Note: There are pre-existing mounting positions on Left Door Panel(F) and Right Door Panel(G) to attach the Handles(K).

Step 6

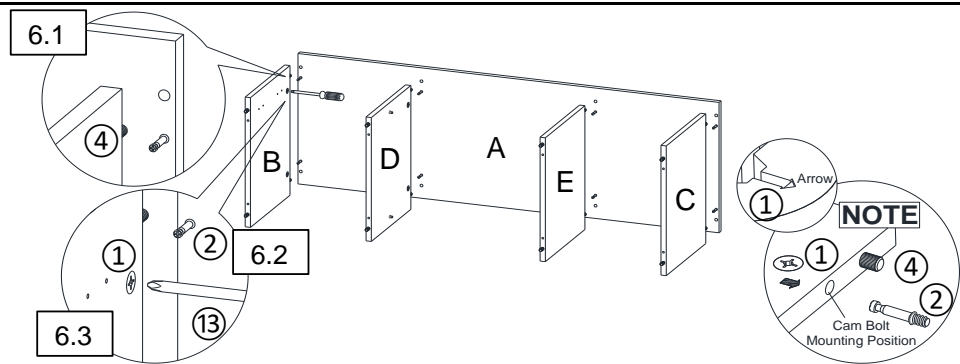

6.1) Insert Positioning Dowels(④) from Left Side Panel(B), Right Side Panel(C), Left Center Panel(D) and Right Center Panel(E) into mounting positions on Top Panel(A).

Note: Ensure the arrows on Cam Locks head points towards the Cam Bolt mounting positions.

6.2) Insert the mounting positions on sides of Left Side Panel(B), Right Side Panel(C), Left Center Panel(D) and Right Center Panel(E) onto Cam Bolts(②) on Top Panel(A).

6.3) Turn the Cam Locks(①) clockwise with the Screwdriver(⑬) until they all lock into place.

Step 7

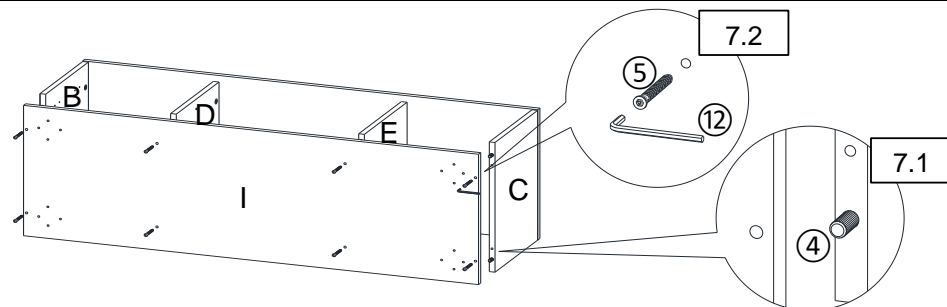

7.1) Insert Positioning Dowels(④) from Left Side Panel(B), Right Side Panel(C), Left Center Panel(D) and Right Center Panel(E) into mounting positions on Bottom Panel(I).

7.2) Attach Bottom Panel(I) to Cabinet Assembly using Cap Wood Screws(⑤) with Allen Key(⑫).

Tighten the Cap Wood Screws fully in a sequential manner.

Step 8

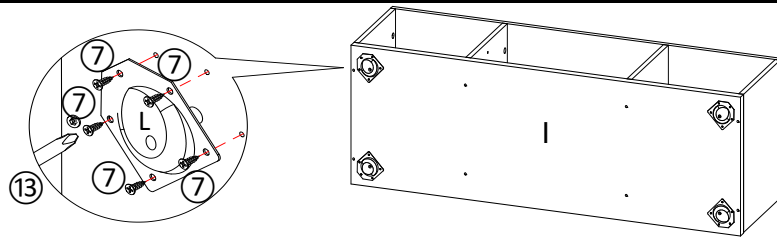

Attach Leg Supports(L) to Bottom Panel(I) using Screws(7) with Screwdriver(13).

Tighten the Screws fully in a sequential manner.

Note: There are pre-existing mounting positions on the Bottom Panel(I) to attach the Leg Supports(L).

Step 9

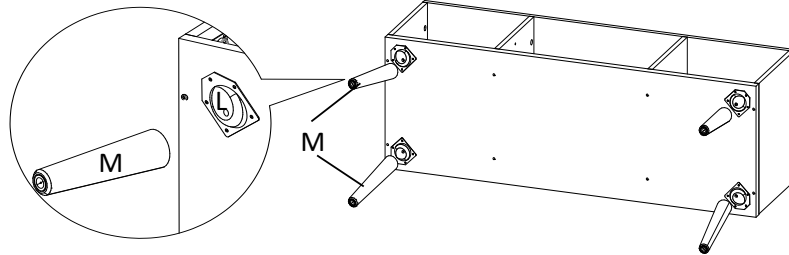

Attach Legs(M) to Leg Supports(L) by rotating clockwise by hand.

Step 10

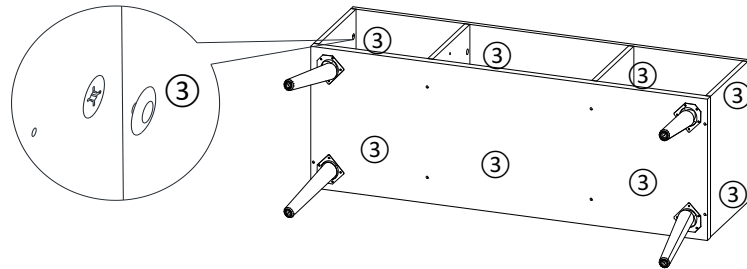

Attach Cam Caps(3) to all Cam Locks(1) by hand.

Step 11

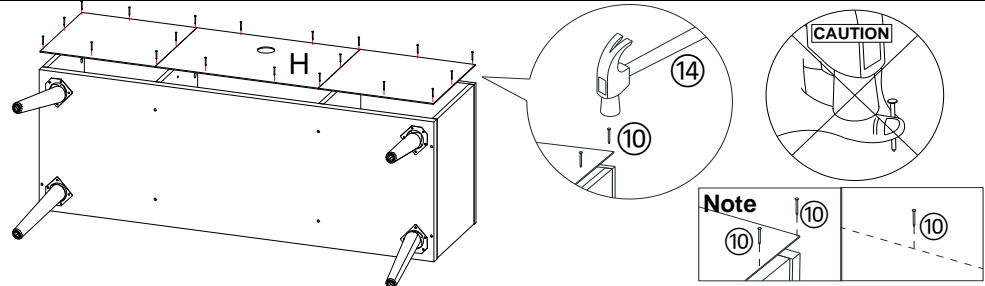

Flip the whole Cabinet over.

Attach Back Panel(H) to Cabinet Assembly using Nails(10) with Hammer(14).

Caution: Please be extra careful when using a hammer to avoid injury.

Note: Hit Nails(10) along all four edges (slightly inwards from sides) on the lines drawn on the Back Panel(H)

Step 12

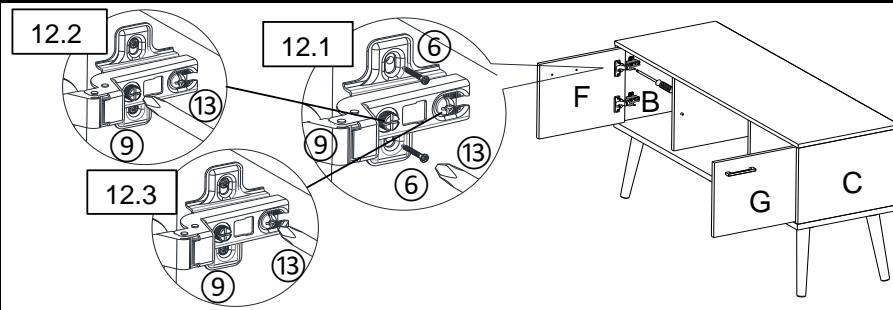

12.1) Attach Connectors(9) to Left Side Panel(B) and Right Side Panel(C) with Screws(6) using Screwdriver(13).

Tighten the Screws fully in a sequential manner.

12.2) Rotate first screw on Connectors(9) to adjust left-right position of Left Door Panel(F) and Right Door Panel(G) when necessary.

12.3) Rotate second screw on Connectors(9) to adjust in-out position of Left Door Panel(F) and Right Door Panel(G) when necessary.

Note: There are lead mounting positions on Left Side Panel(B) and Right Side Panel(C) to attach Connectors(9).

Step 13

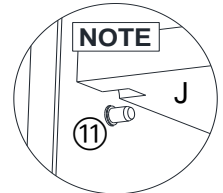
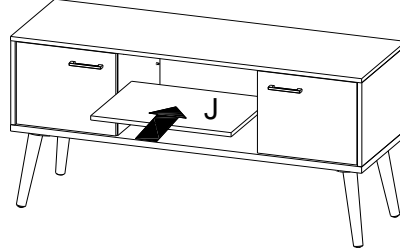

Put Shelf Panel(J) in place on Metal Shelf Supports(11).

Note: There are lead mounting positions on Shelf Panel(J) to fit Metal Shelf Supports(11).

Cabinet Restraint Device Installation Instructions

WARNING

Serious or fatal crushing injuries can occur from tipping furniture.
To help prevent tip-over: ALWAYS secure this furniture to the wall using Cabinet Restraint Device.
See product instructions for more ways to help prevent furniture tip-over.

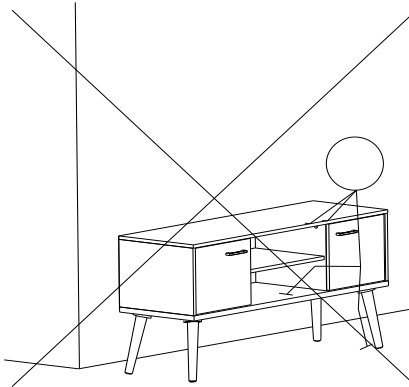

Usage For Cabinet Restraint Device:

For TV Cabinet against wall, attach two Metal Brackets(16) on wall and product, use Cabinet Restraint Strap(20) to connect the Metal Brackets(16).

Instructions:

Step 14

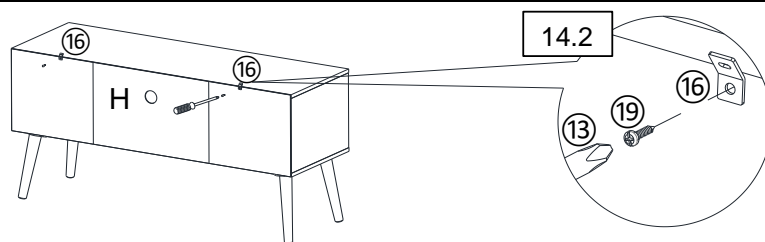

14.1) Turn the TV Cabinet so the back side faces you.

14.2) Attach Metal Brackets(16) to Back Panel(H), where Labeled using Pan Head Screws(19) with Screwdriver(13).

Step 15

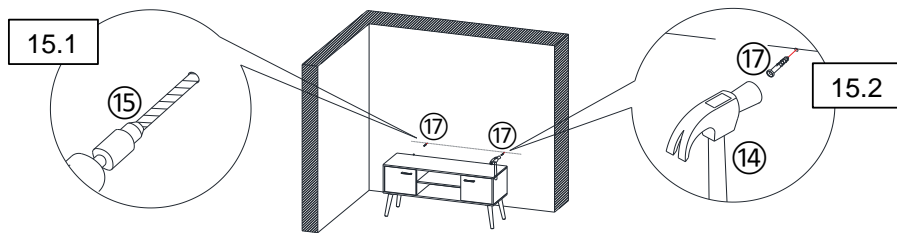

15.1) Drill two holes on wall at same height as Metal Brackets(16) on TV Cabinet with Power Drill(15).

You can mark these points in two ways as below:

1) Move the TV Cabinet back to the wall. Mark two points same height as TV Cabinet on the wall.

Note: The Metal Brackets need to be secured to solid, load bearing surface. Please use a Stud Finder(not supplied) if needed to locate the Wall Frame.

2) Measure the height of the Metal Brackets(16) with ruler/measuring tape and mark on wall to keep them accurate and same height.

15.2) Insert Wall Plugs(17) into drilled holes on wall with Hammer(14).

Step 16

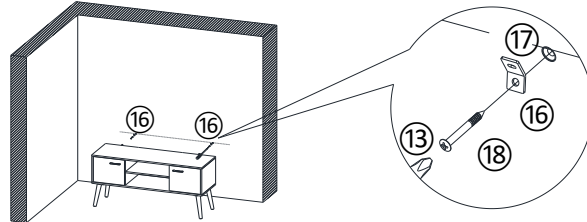

Attach Metal Brackets(16) to Wall Plugs(17) using Wall Plug Screws(18) with Screwdriver(13).

Step 17

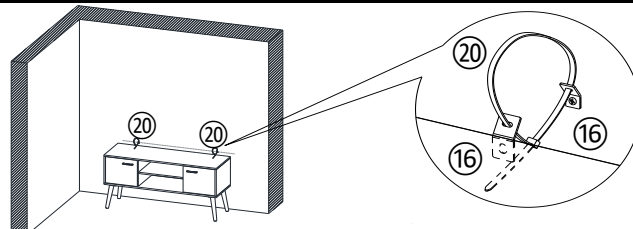

Move TV Cabinet to the wall.

Pull the Restraint Straps(20) through the Metal Brackets(16) on the wall and TV Cabinet one by one, and pull the Restraint Straps(20) tight.



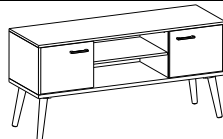







Step 18



Your TV Cabinet is ready for use.

This TV Cabinet can only be used on a flat, level surface.

Care & Maintenance

-  Furniture may scratch floors. We recommend using furniture pads to protect your floors.
-  Do not put hot items directly on furniture surface.
-  Do not clean furniture with harsh cleansers or polish.
-  Do not place furniture under direct sunlight.
-  Do not place furniture near heating or cooling vents.
-  Do not write on furniture without a padded barrier to protect the surface.
-  Do not place furniture outside . For indoor use only.
-  Not for commercial use. For residential use only.
-  Stains may be removed with mild soap solution and damp cloth.
-  Children should not climb or jump on the furniture.
-  Dust and pick-up spills using a clean, non-colored, lint-free cloth.