

# Assembly Instructions

**Caution : You must read this before you proceed**

## Side Table

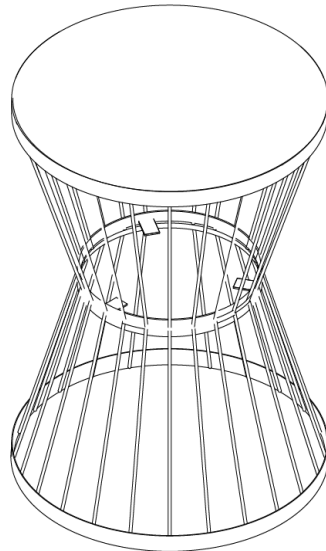

### Parts List

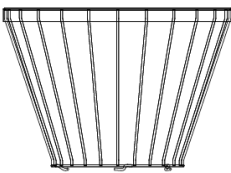
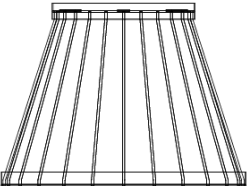
Label	Picture	Description	QTY
A		Top	1
B		Base	1

## Assembly Preparation

Before  
Beginning  
Assembly:

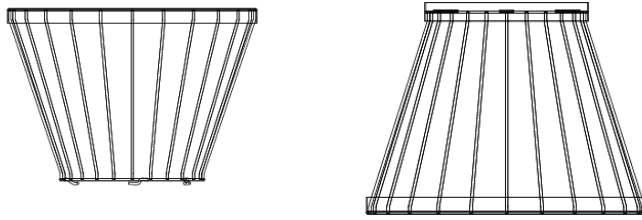

- Read instructions, cover to cover-



- Have 2 adults on hand for assembly-



- Do not assemble on flooring or carpet-



- Assemble on a clean non-marring surface (packing foam)-



- Save all packaging until finished-

## Assembly Steps

### Overview

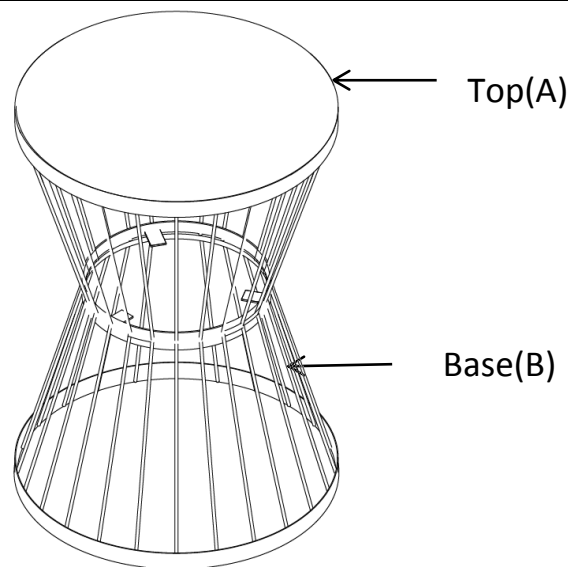

This Side Table has multiple parts and may require a few minutes to assemble. To give you an overview of the Side Table parts, the above picture is to help you put the various parts into perspective. Please read through the instructions below to familiarise yourself with the parts and steps before assembly.

### Step 1

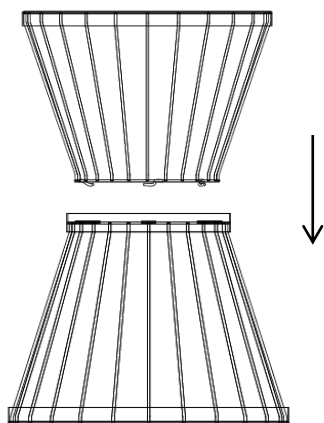

Align the Top(A) and Base(B) as pictured above.

### Step 2

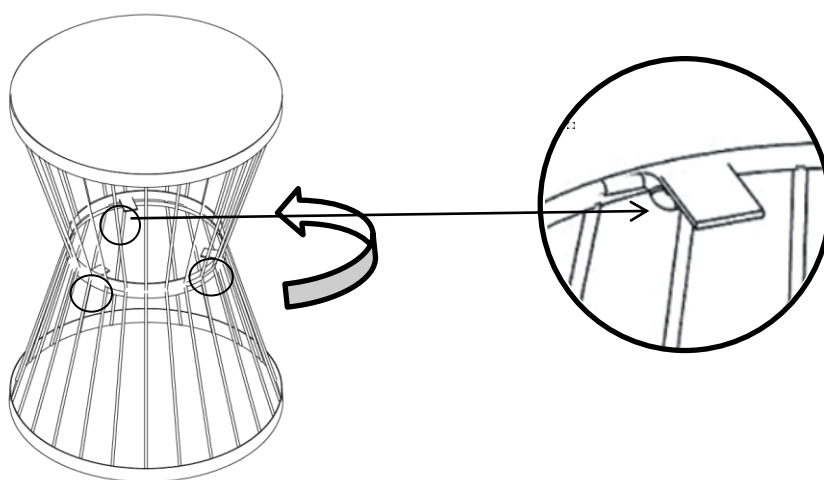

Rotate the Top(A) along the Base(B) until the Tapers lock into place.



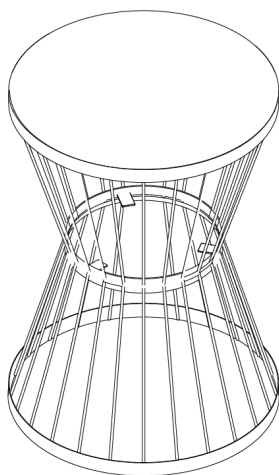















### Step 3



Your Side Table is ready for use.

**This Side Table can only be used on a flat, level surface.**

## Care & Maintenance

-   ● Do not put hot items directly on furniture surface
  -   ● Do not clean furniture with harsh cleansers or polish.
  -   ● To obtain the longest lifespan of your outdoor products, minimizing exposure to direct sunlight is recommended.
  -   ● Children should not climb or jump on the furniture.
  -   ● Do not write on furniture without a padded barrier to protect the surface.
  -   ● To obtain the longest lifespan of your outdoor products, avoid extended and lengthy exposure to rain, snow, and direct sunshine. Whenever possible cover the product and /or place under patio or awnings.
  -   ● Not for commercial use. For residential use only .
  -   ● Stains may be removed with mild soap solution and damp cloth.
- 
-   ● Dust and pick-up spills using a clean, non-colored, lint-free cloth .