

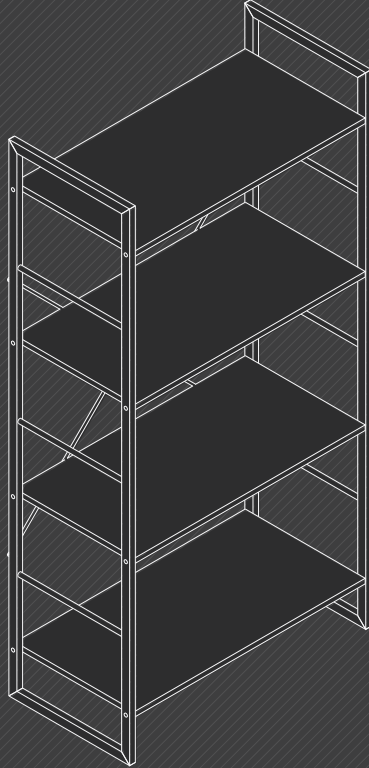

4-TIER STEEL & WOOD RECTANGULAR BOOKCASE



USER MANUAL



Contents

TOPIC

PAGE

01	SAFETY INSTRUCTIONS	01-01
	1-1 Thank You For Choosing Our Product	01
	1-2 Precautions	01

02	INSTALLING MODULES	02-06
	2-1 Disassembly Diagram	02
	2-2 Parts List	03
	2-3 Assembly Instructions	04-06

03	CUSTOMER SERVICE	07
	3-1 30-Day Return Policy	07
	3-2 1-Year Warranty	07
	3-3 Quick Response Within 24 Hours	07

04	PROBLEMS YOU MAY ENCOUNTER	08
	4-1 Problems You May Encounter	08

Safety Instructions

Thank You For Choosing Our Product

Before assembly, please read this USER MANUAL first, and check according to Parts List to make sure all parts are included. Feel free to contact us if you have any concerns or questions about your product, we are always ready to help. Your satisfaction is our first priority!

Precautions

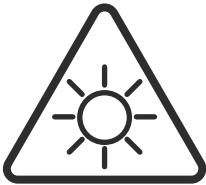

- Avoid long-term direct sunlight exposure.



- Keep away from sharp objects.

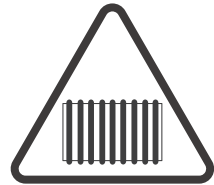

- Keep away from heat.



- Keep infants/children away from assembly parts to avoid choking and suffocation.



- Keep away from corrosive substances.

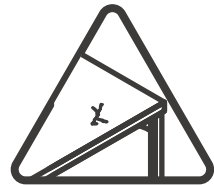

- Pay attention to avoid over-tightening fasteners, or they may induce cracking within the board.



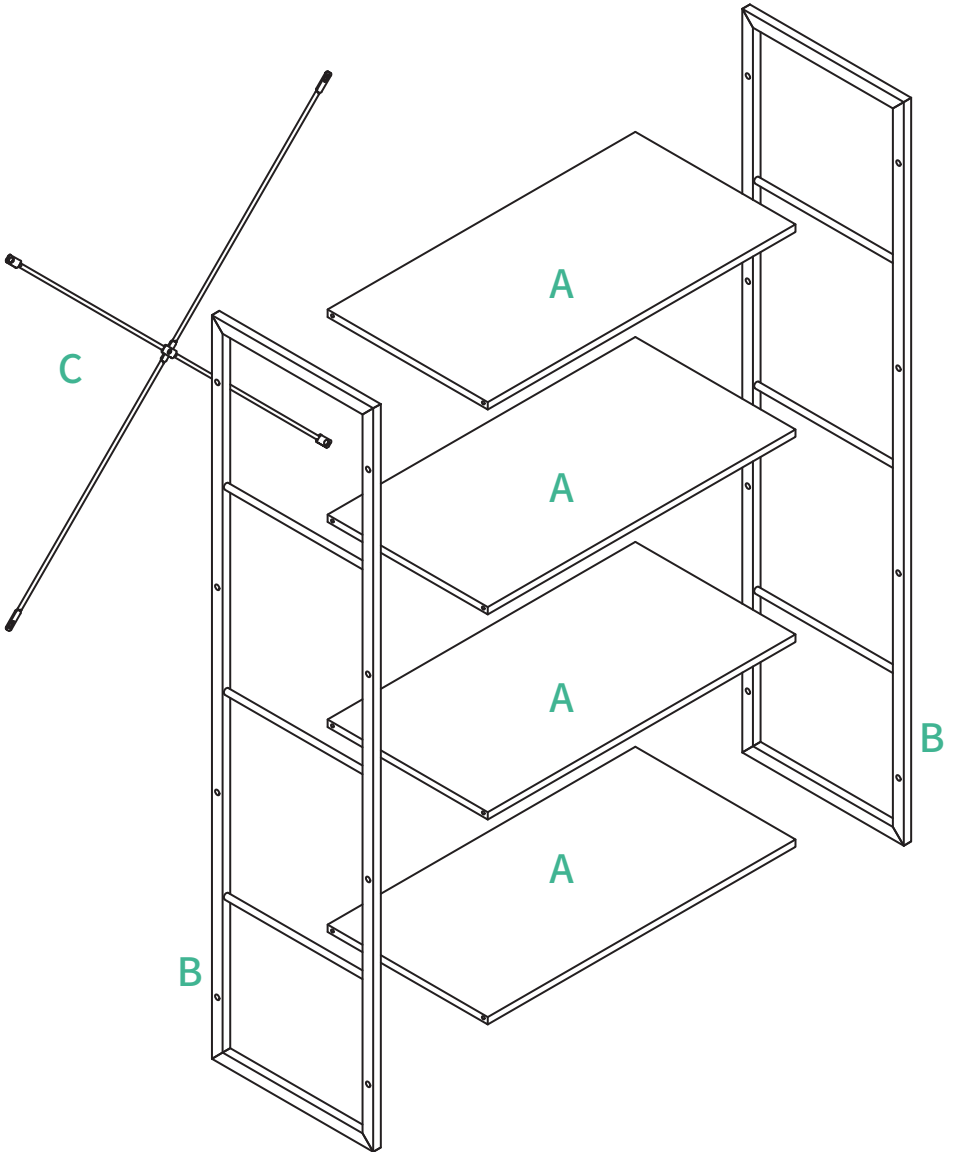





Disassembly Diagram

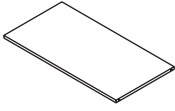

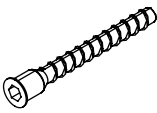
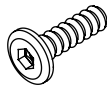
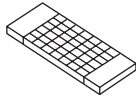
Parts List

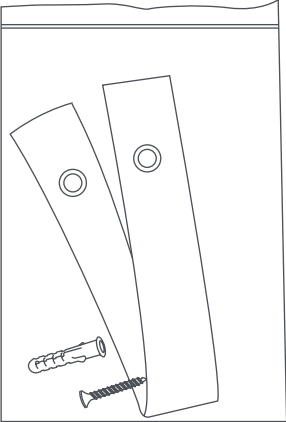
For ease and safety, we recommend two people for assembly.

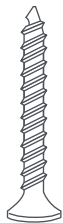

<p>A x4</p> 	<p>B x2</p> 	<p>C x1</p> 	
<p>1 x18</p>  <p>M6X40 2 Spares</p>	<p>2 x5</p>  <p>M6X10 1 Spare</p>	<p>3 x4</p>  <p>Rubber Pad</p>	<p>4 x2</p>  <p>1 Spare</p>
<p>5 x1</p>  <div style="display: flex; justify-content: space-around; align-items: center;"> <div style="border: 1px solid black; padding: 5px; width: 45%;"> <p>a</p>  <p style="text-align: right;">ax1</p> </div> <div style="border: 1px solid black; padding: 5px; width: 45%;"> <p>b</p>  <p>M5-40x1</p> </div> <div style="border: 1px solid black; padding: 5px; width: 45%;"> <p>c</p>  <p>Expanded nails x1</p> </div> </div>			

Assembly Instructions

1

Please note that the holes marked by the arrows on the steel frame are on the same side.

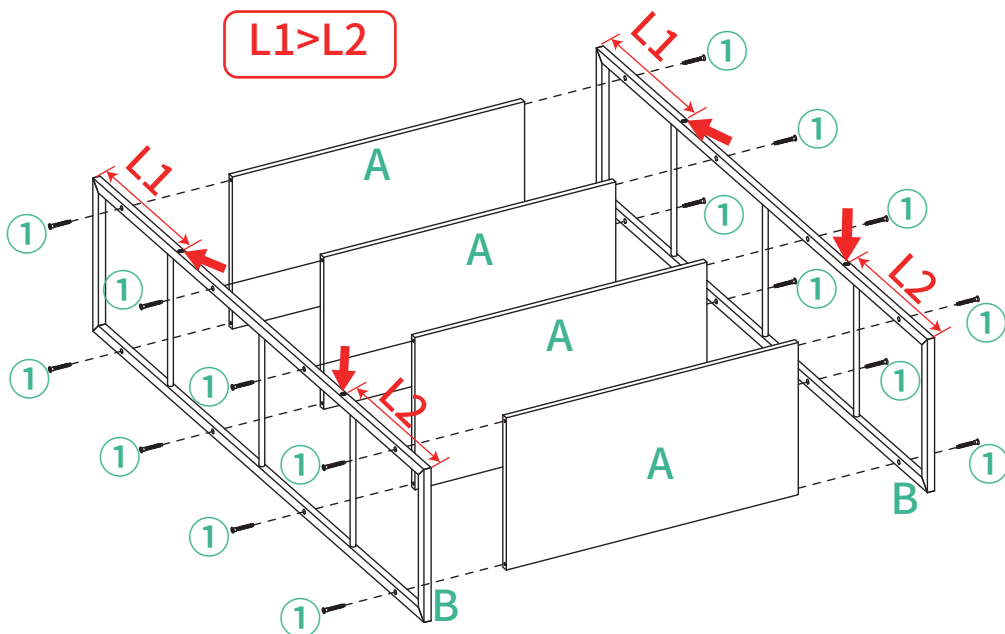

A x4		B x2	
1 x16		4 x1	

Assembly Instructions

2

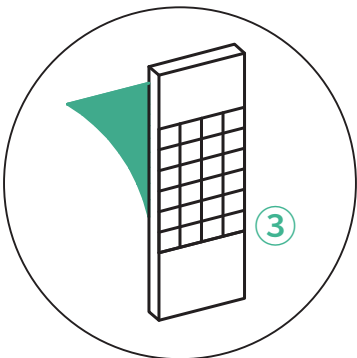
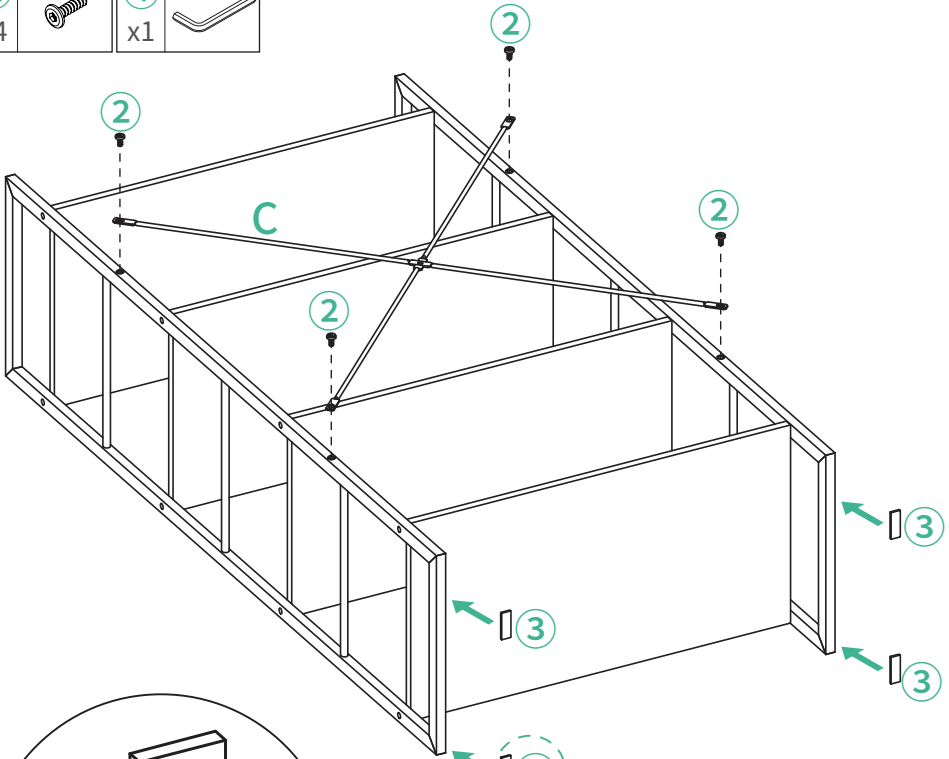
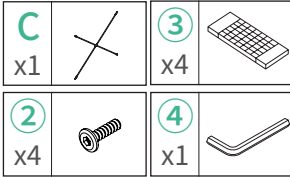

Assembly Instructions

3

Use a power drill to make a diameter 6mm hole in the wall. Use philips head screwdriver or stubby screwdriver, screw the plastic anchors into the holes until they are flush to the wall. Fix a,b,c together, insert the metal screw into the drywall anchor, tilt your philips head screwdriver, and then lock to the wall, but do not over tighten.

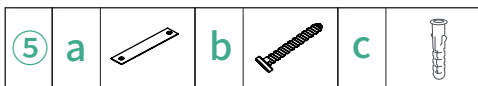
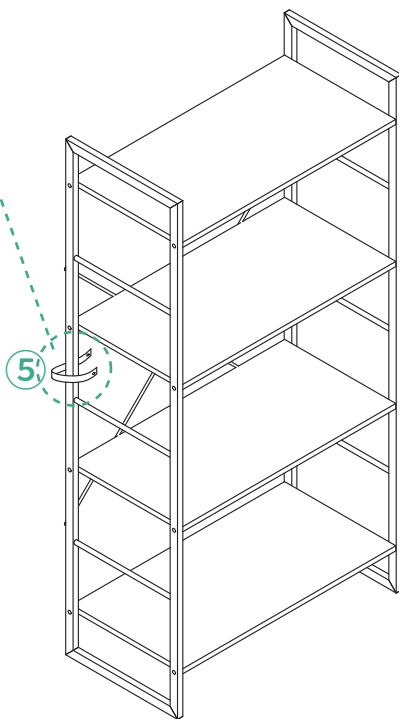
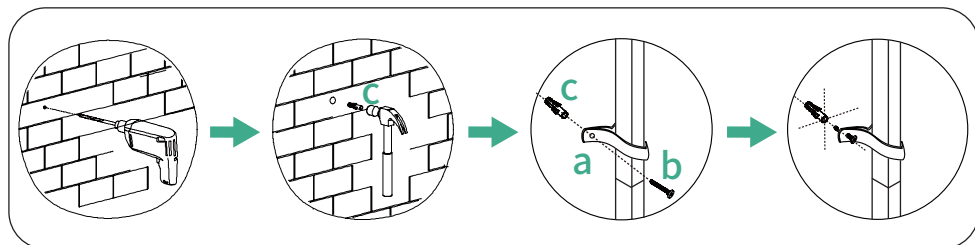



30 DAY Return Policy

If you're not completely satisfied with your purchase, please return the merchandise via our Official Customer Support. Unused merchandise can be refunded or exchanged within 30 days of purchase.



1-Year Warranty

We guarantee your product is free from defects in product material and workmanship for one (1) year starting from the date of purchase during normal use of household conditions. If your appliance fails to operate properly within our warranty period, we will arrange a new one. Replacement is free and all shipping costs are covered.



Quick Response within 24 Hours

If you are still unable to resolve the issue you are experiencing, please contact us immediately via our support email. It doesn't matter if the product has been installed or not, our customer support team will respond within 24 hours and assist you quickly and efficiently. The most efficient way to confirm your problem to us is to attach a video, which illustrates your product issues.

Problems You May Encounter

PART	PROBLEM	SOLUTION
Whole Product	Parts are missing, defective or having wrong parts in package.	You can contact us and we will get back to you within 24 hours. Or, you can reach us via after-sales email.
	Having issue(s) while reading the instruction or completing the assembly.	You can contact us and we will get back to you within 24 hours. Or, you can reach us via after-sales email.
	Encountering non-human caused damage during usage.	If the product is damaged due to non-human causes, please keep the product and send us photos of it. We will ascertain the cause of the product damage within 48 hours and provide you with a satisfactory solution.
Table Surface	Board Surface is broken, scratched or lack of somescrew holes.	You can contact us and we will get back to you within 24 hours. Or, you can reach us via after-sales email.
	The screw holes that on the board and the steel frame don't line up.	<ol style="list-style-type: none"> 1. Please tighten the screws on the board by 70%, do not tighten completely. 2. Adjusting board and steel frame until the screw holes are lined up, then tighten all the screws.
	The desk board is uneven or not tight that has gaps after being assembled.	<ol style="list-style-type: none"> 1. Loosen the screws in the uneven or gap positions; adjust until the desktops are flat and tight, and then tighten the screws. 2. If your problem still can't be solved, please feel free to contact us.
Steel Frame	The steel frame is bent, broken, painted, rusted or damaged.	You can contact us and we will get back to you within 24 hours. Or, you can reach us via after-sales email.
	The table is unstable after being assembled.	<ol style="list-style-type: none"> 1. Check if the screws are tightened. 2. Read throughout the manual, check are there any parts installed incorrectly or missing assembled. 3. If your problem still can't be solved, please feel free to contact us.
	Encountering non-human caused damage during usage.	If the product is damaged due to non-human causes, please keep the product and send us photos of it. We will ascertain the cause of the product damage within 48 hours and provide you with a satisfactory solution.

We are committed to providing our customers with premium quality products and convenient customer service.

MADE IN CHINA