

Installation Guide

WALL-HUNG TOILET

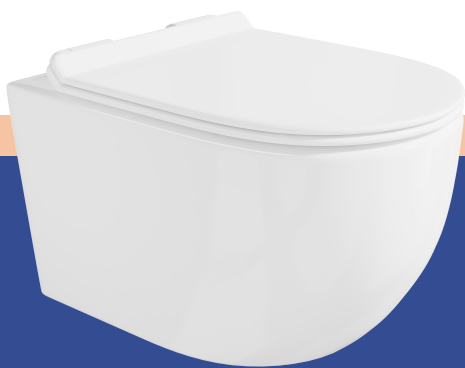

Prior to Installation



- Inspect the toilet to ensure no damages have occurred during transit.
- Observe all plumbing and building codes in accordance with your state and local requirements.
- All dimensions are nominal. The actual size of item received might vary by up to 1/8 inch. Make sure to measure your toilet before installation.
- Confirm that the item received will fit in the intended location and that plumbing fixtures are located where legally required before installation begins.
- The step-by-step guide in the installation instructions is for general reference only. Should there be any discrepancies, We cannot be held liable. It is recommended that all products be installed by a licensed professional.
- Read installation and maintenance instructions thoroughly before installing. Be sure to use proper tools and always wear proper personal safety equipment.
- Two people are required to handle and install the toilet to avoid personal injuries or accidental damage to the item.
- Diagrams are for general display and do not represent a specific model.

Tools Required/Suggested



Safety Glasses

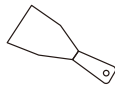

Putty Knife

Plus:

- Lubricant
- File
- Screwdriver
- Pencil
- Spirit Level

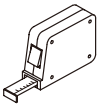

Tape Measure



Adjustable Wrench

Parts List:

- (1) Wall-Hung Toilet Bowl
- (2) Mounting Hardware
- (3) Toilet Seat
- (4) Toilet Seat Installation Kit

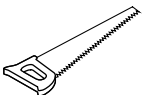

Hack Saw

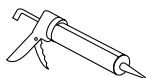

Sealant

Installation



⚠ NOTE This is the installation instruction for wall-hung toilet bowl only. An in-wall tank carrier must be installed prior to this.

STEP I. Cut and Insert Pipes

a. Dry Fit and Mark

- Remove mudguards and mounting stud covers from the tank carrier.
- Fully insert the outlet pipe and inlet pipe into the wall. Mark the finished wall location on each pipe.
- Apply lubricant on the rubber washers of the inlet and outlet pipe, then fully insert both pipes into the toilet bowl and mark the positions on both pipes where flush with the back of the toilet.

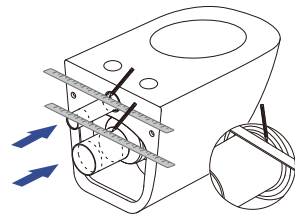
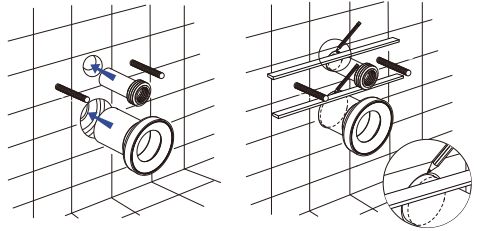

b. Measure and Cut to Length

- Measure the distance between the marked lines on each pipe to get the lengths(L1, L2) to be cut.
- Mark respectively the same lengths(L1, L2) from the end of each pipe and cut.

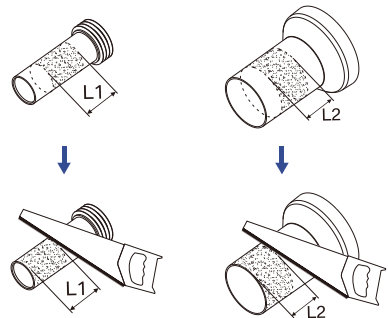

L1: The distance between the marked lines on the inlet pipe.

L2: The distance between the marked lines on the outlet pipe.

Installation

- After cutting, deburr and bevel the pipe edges with a file.

c. Insert Pipes

- Apply lubricant to the joint surfaces of the inlet and outlet pipe and fully insert them into the wall.

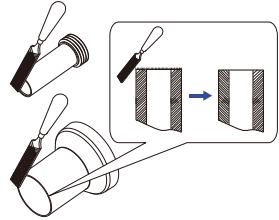

STEP II. Mount Toilet Bowl

- Stud Cap x2

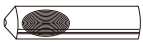

- Mounting Part x2

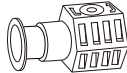

- Allen Wrench



- Allen Nut x2



a. Insert Stud Caps

- Measure the distance between the back of the toilet and the center of the toilet seat mounting hole to get length X.
- Insert a stud cap onto one of the mounting studs and mark length X from the center of the notch of the stud cap on the mounting stud.
- Remove the stud cap and measure the distance between the stud end and the mark to get length Y.

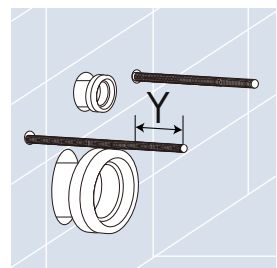
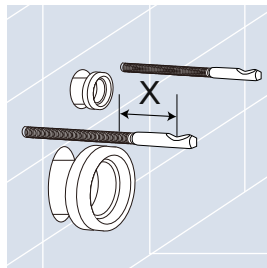
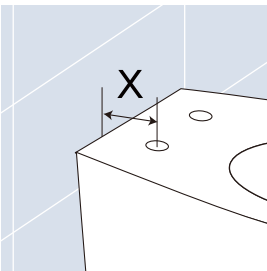

Installation

- Mark length Y from the finished wall location on both mounting studs and cut off the extra length, then insert the stud caps.

b. Mount Toilet Bowl

- Place the Allen nuts onto the mounting parts and install them in the toilet bowl through mounting holes in the back.
- Attach the toilet bowl to the mounting studs through the mounting holes and make it fit fully against the wall.

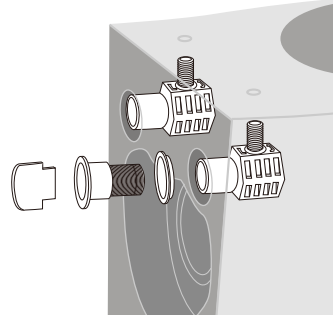

c. Secure and Seal

- Use the provided Allen wrench to fully tighten the nuts into place.
- Fill any gaps with cement or sealant.

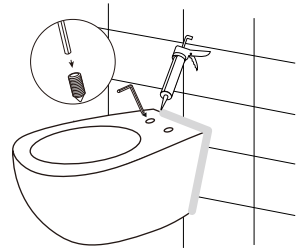

NOTE Ensure the toilet is supported by a suitable prop until screws securely fastened and sealant properly applied.

STEP III. Install Toilet Seat

- Insert the toilet seat screws into the hinges as shown in the illustration.
- Plug the hinges in the mounting holes for toilet seat and lightly tighten with a screwdriver to allow for later adjustment.

Installation

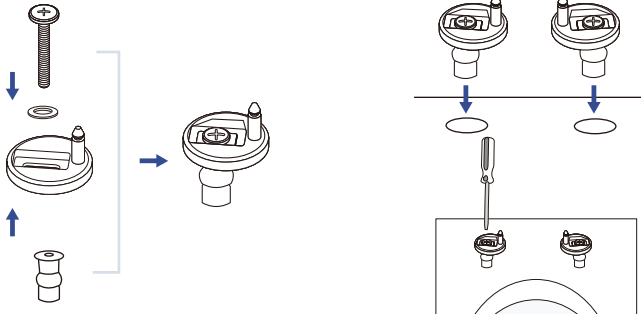

- Attach the toilet seat onto the hinges and adjust to align the seat to the bowl, then remove the toilet seat.

- Firmly tighten the hinges, put the hinge caps on and install the toilet seat.

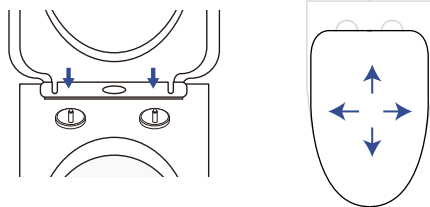

For quick-release models:

- To quickly remove the seat, press the button and gently pull the seat from the attached hinges.

- To quickly install the seat, press the button, align the pre-drilled holes on the seat with the hinges, and adjust the seat to align with the bowl.

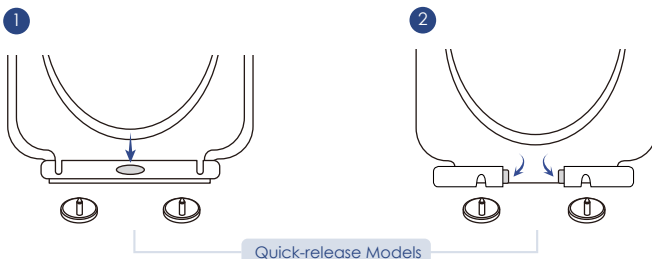

We toilets are meticulously constructed with solid vitreous china and have undergone strict quality inspections. With proper care and cleaning measures, toilets will keep in new condition and function well for an extended period of time.

General Care

- It's recommended to clean toilets on a regular basis to avoid grime and mineral build-ups or deposits.
- Shut off water supply and clear up tank and fittings once in a while to maintain best flushing performance.
- For leakage or flushing problems, it's always recommended to consult with a professional to address and solve specific issues.

Do's



- ✓ Rinse thoroughly and make sure there is no residue after every use and cleaning session.
- ✓ Freshen up the glaze using mild solutions on a regular basis.
- ✓ Clean the toilet and seat on a regular basis.
- ✓ Always use flushable wipes.



Mild
Detergent



Soft
Cloth

Don'ts



- ✗ Avoid using harsh cleaners or abrasive brushes.
- ✗ Avoid using bleach tablets in the tank.
- ✗ Avoid dropping heavy or sharp objects onto the bowl.
- ✗ Avoid flushing non-flushable items.
- ✗ Avoid waste accumulation in the bowl.



Abrasive
Brushes



Heavy
Object

Installation Guide