

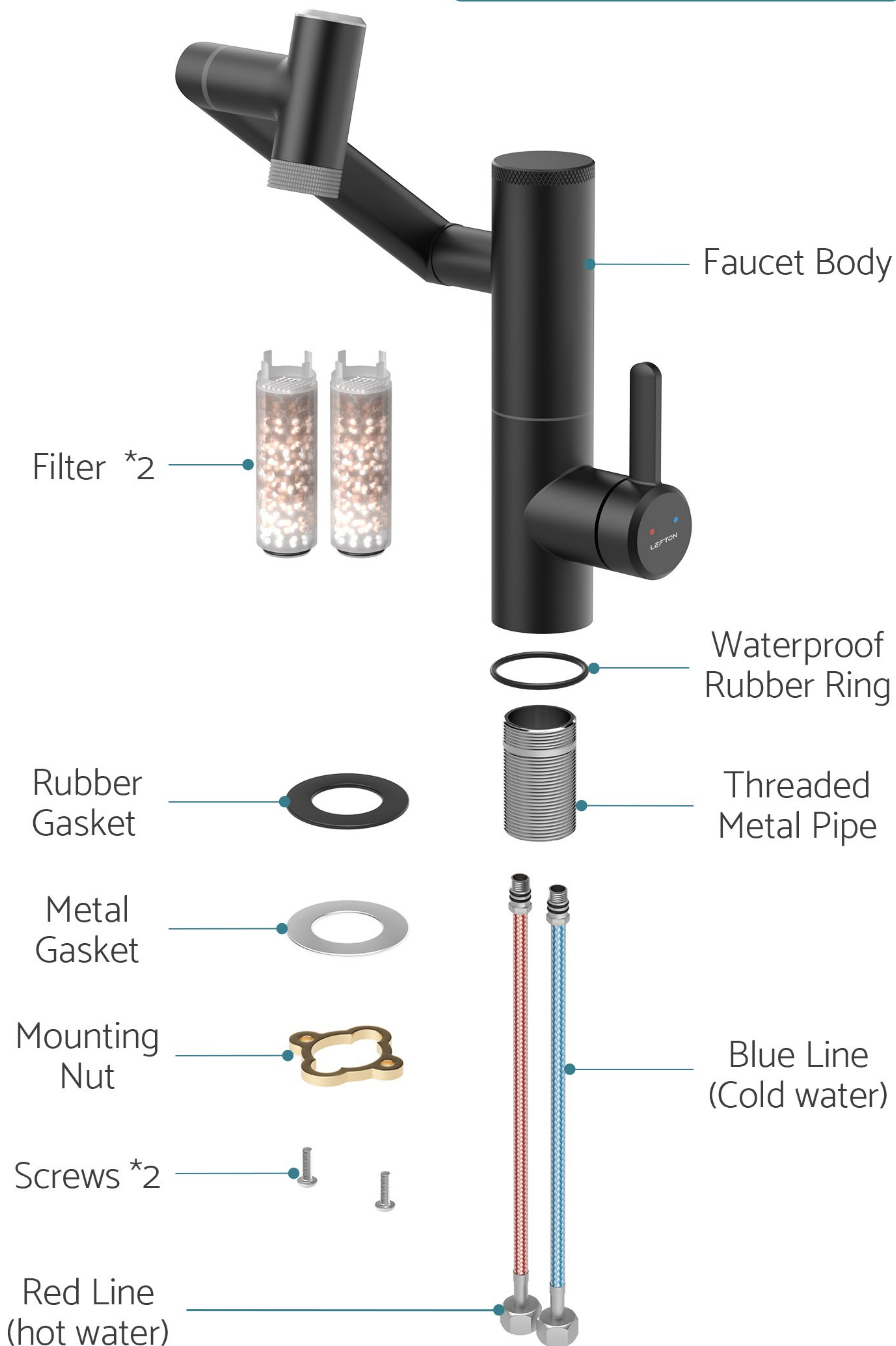
LEFTON

Installation Manual

BPF01

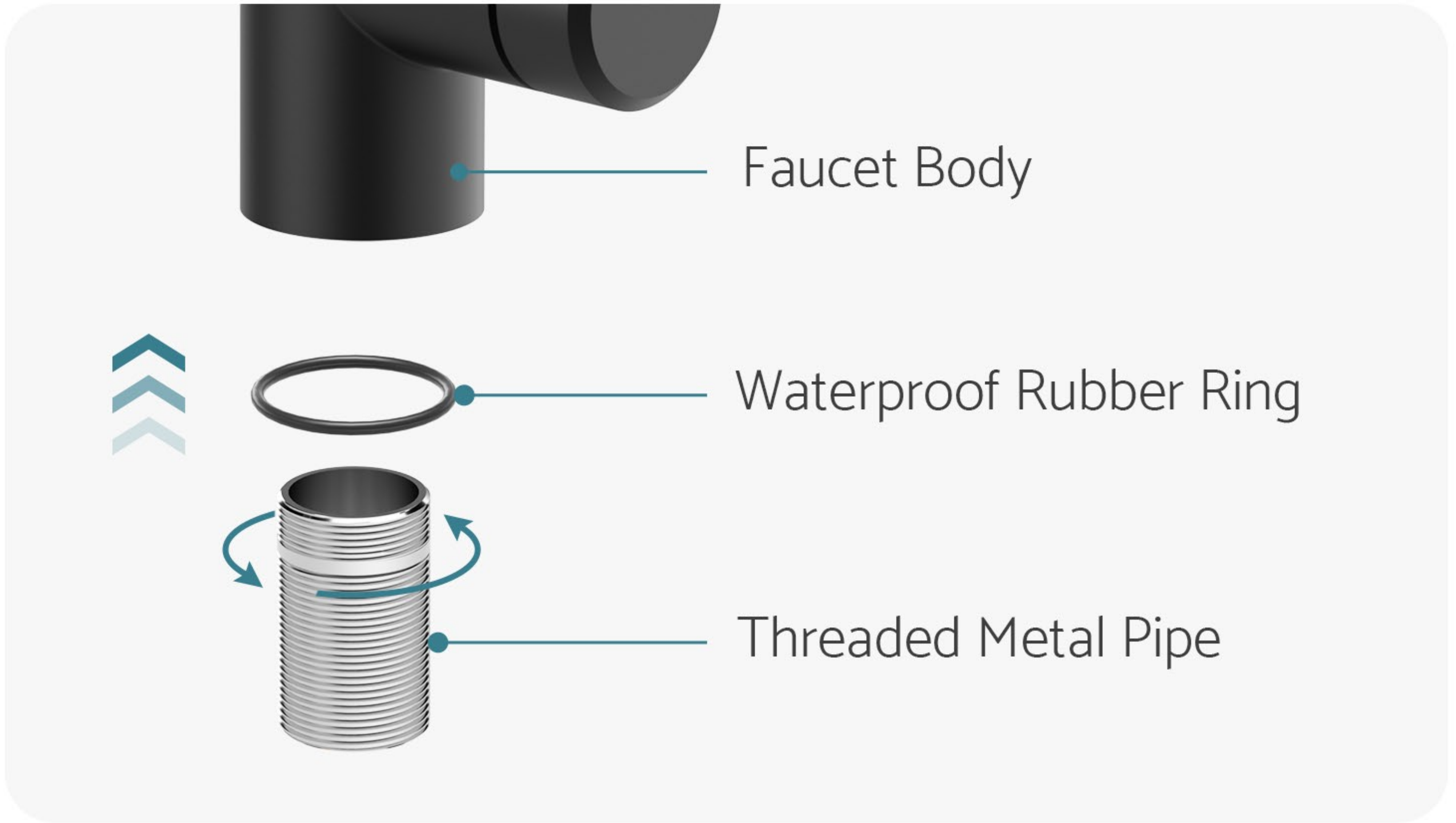


Diagram and Parts List



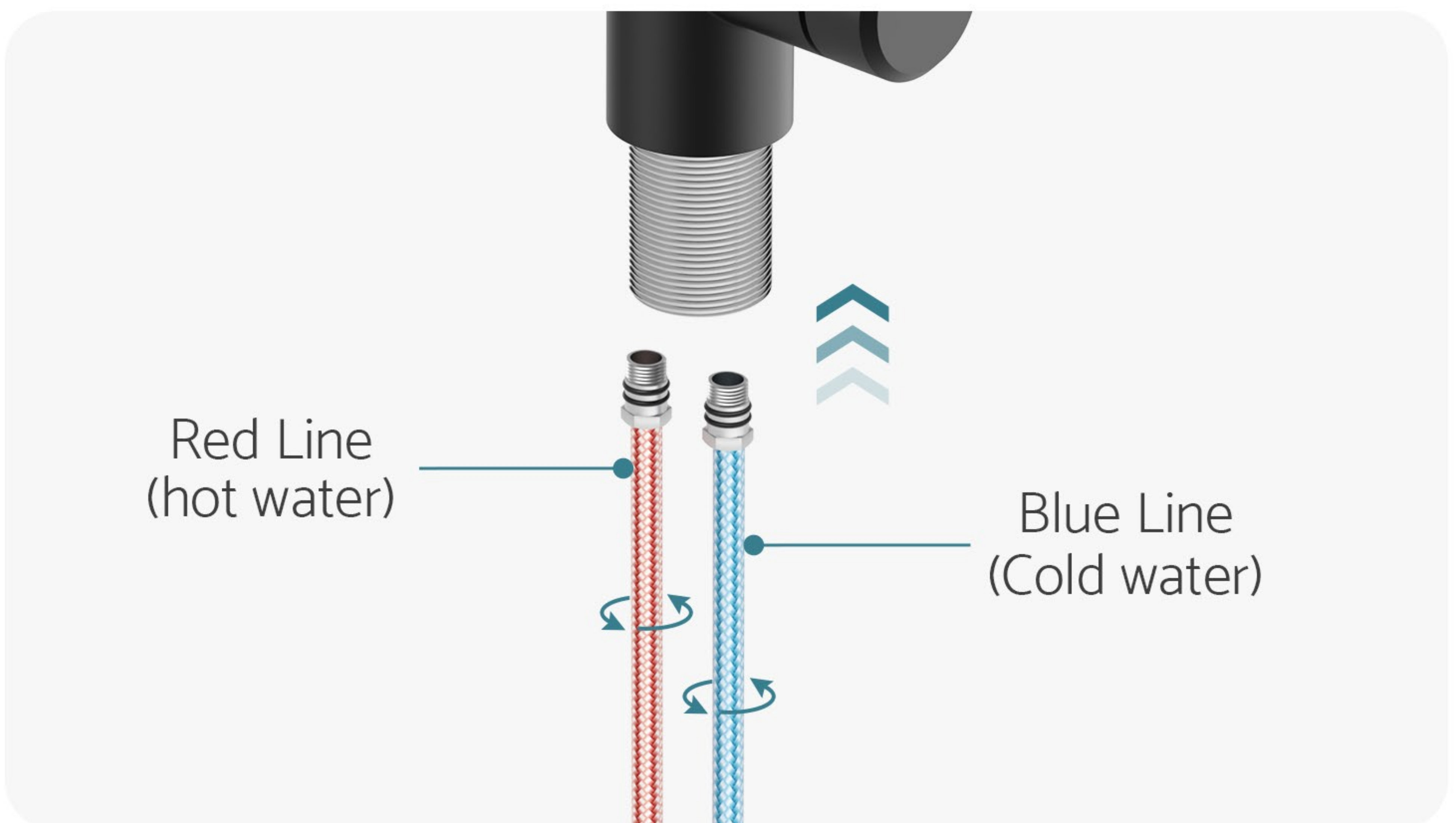
STEP 1:

Installing the faucet assembly.



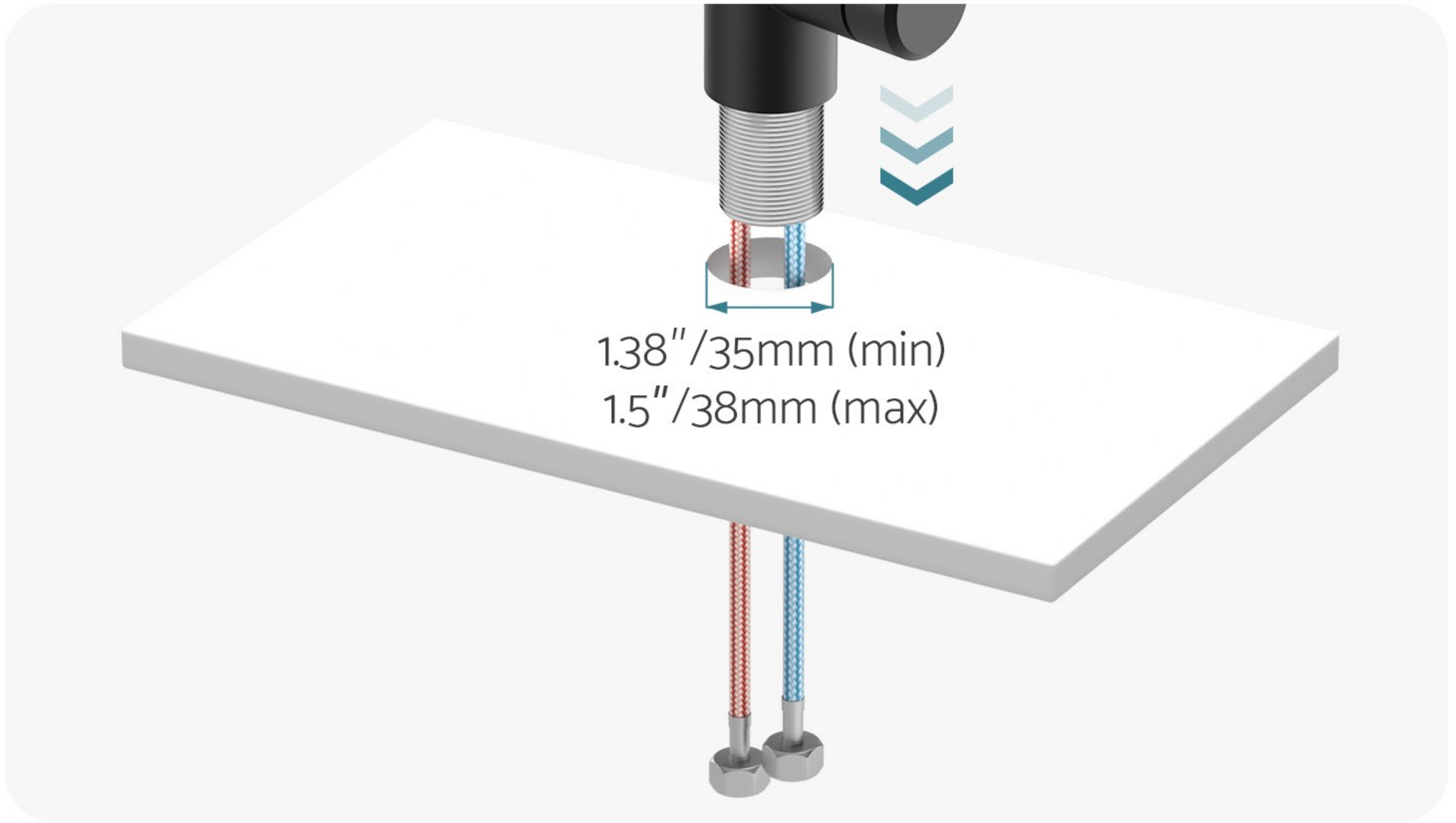
STEP 2:

Connect the Hot, Cold water lines, and tighten them clockwise.



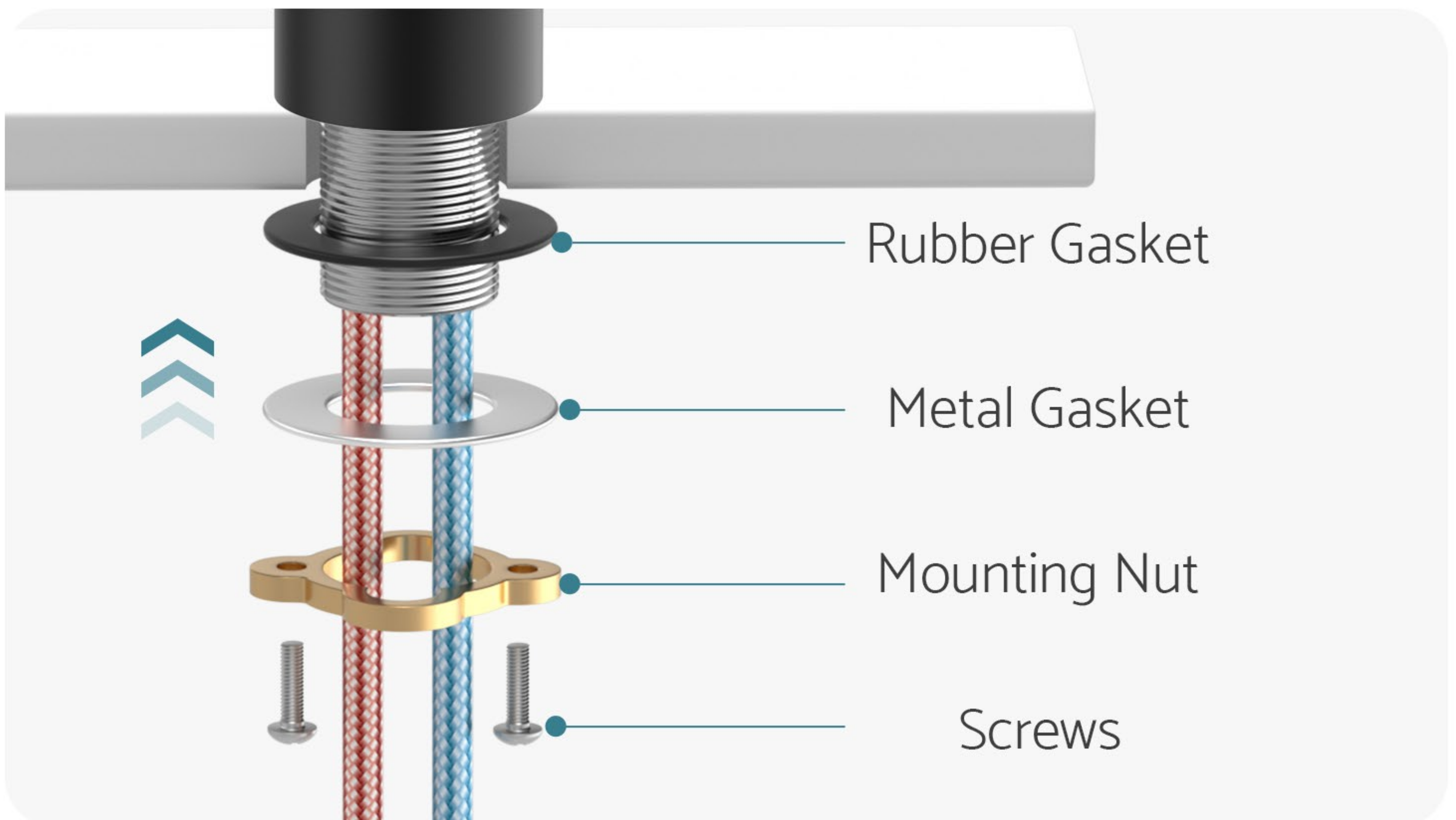
STEP 3:

Install the faucet to the countertop.



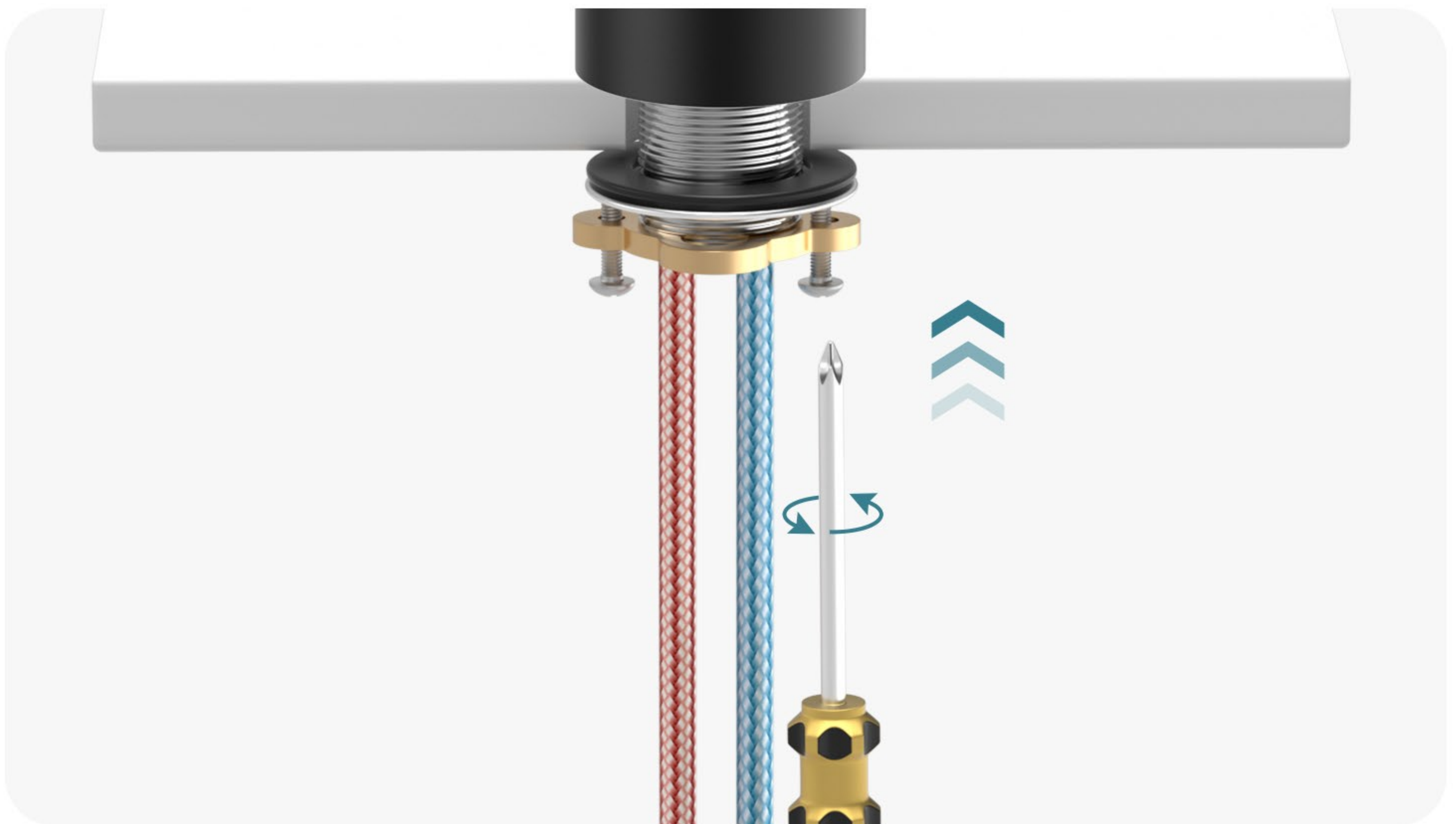
STEP 4:

Install gaskets, nut and fasten the screws.



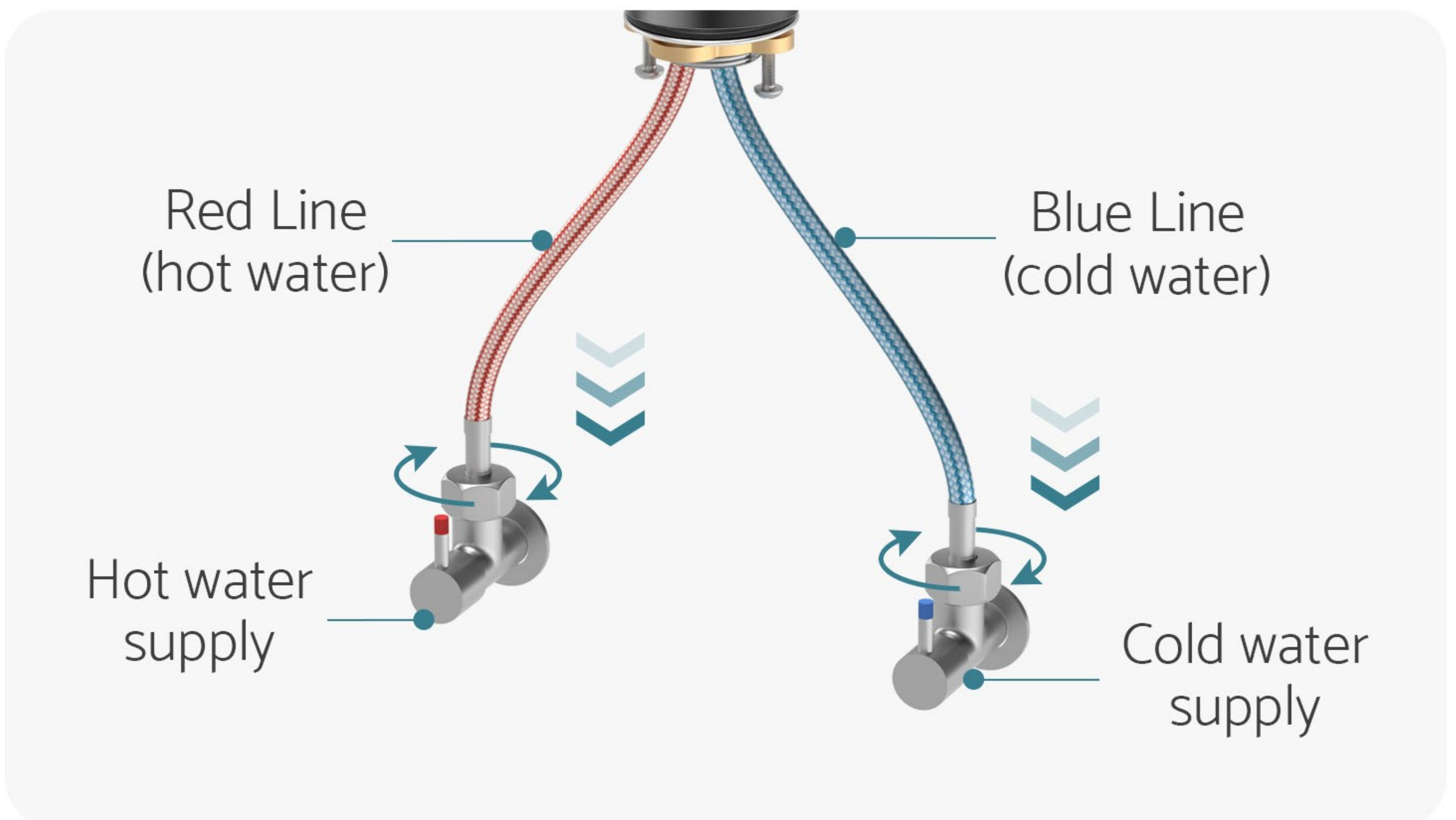
STEP 5:

Fasten the screws with the screwdriver.



STEP 6:

Connect the Hot, Cold water supply.



STEP 7:

Turn the faucet on and check for leaks.

