

Part list

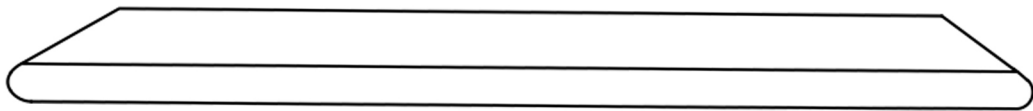

①

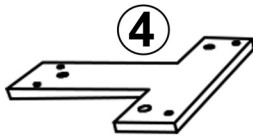

④

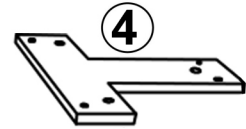

④

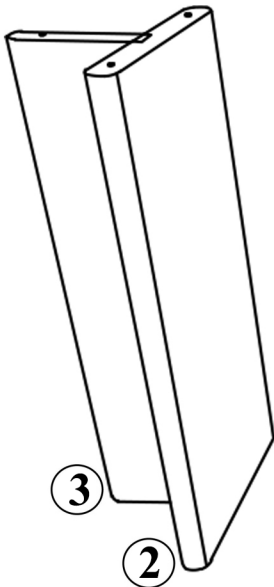

③



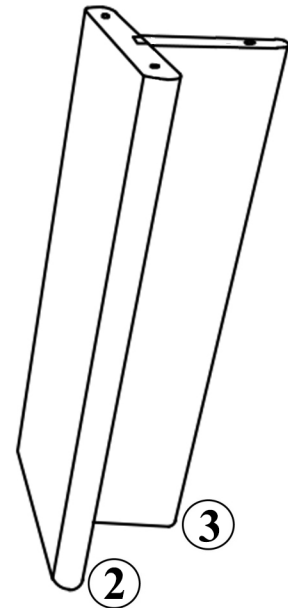





②

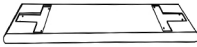

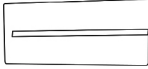
③

②

TWO CARTONS /HARDWARE LIST

PART LISTS				HARDWARE LIST			
NO	DESCRIPTION	SKETCH	Q'TY	NO	DESCRIPTION	SKETCH	Q'TY
①	TOP FRAME		1 PC	Ⓐ	BOLT Ø8*30mm		14PCS
				Ⓑ	FLAT WASHER Ø13*1mm		14PCS
②	LEG		2PCS	Ⓒ	ALLEN KEY		1 PC
				Ⓓ	BOTTON		6PCS
③	LEG		2PCS	Ⓔ	METAL PLATE		2PCS
				④	LEG TOP		2PCS

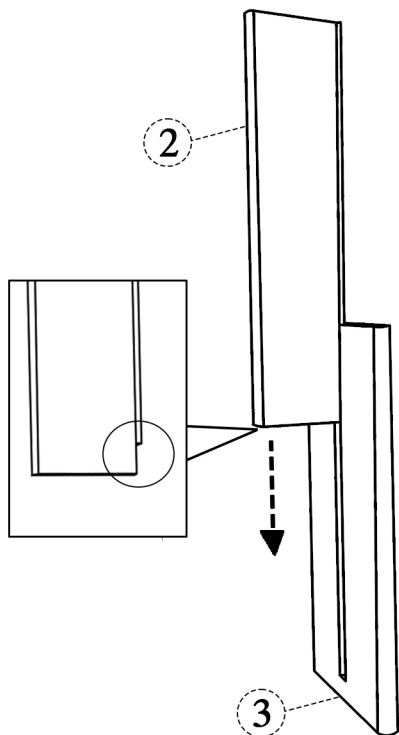

STEP 1 x2

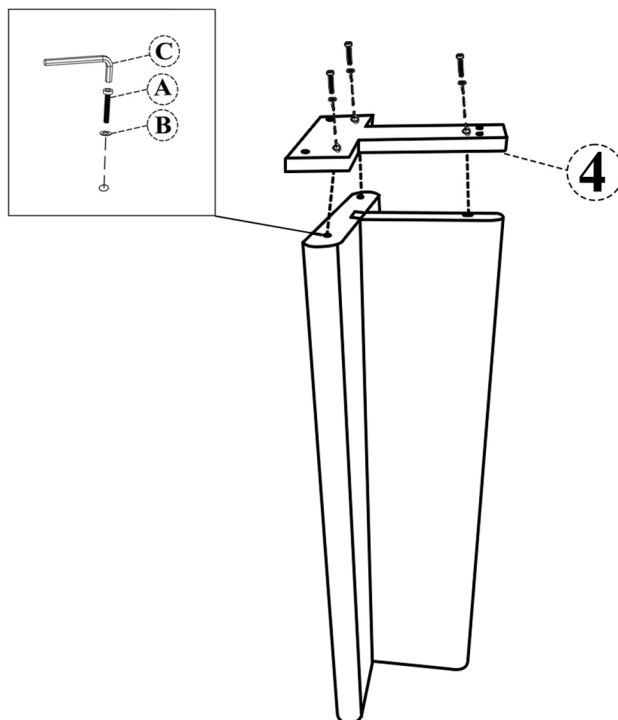

STEP 2 x2





Don't tighten the bolts until all 3 bolts are slightly secured.

A	Q'ty : 6pcs	B	Q'ty : 6pcs	C	Q'ty : 1pc
	Ø8*30mm		Ø13*1mm		

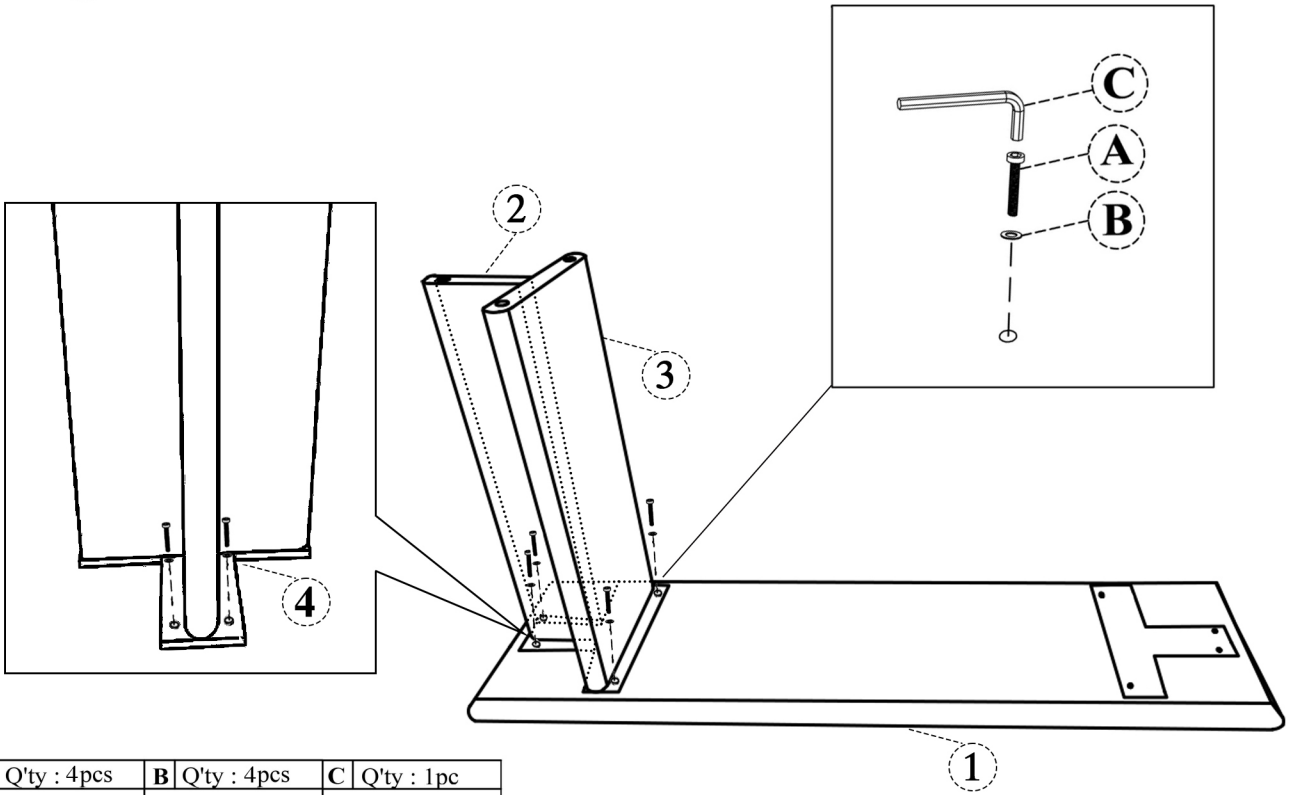



STEP 3

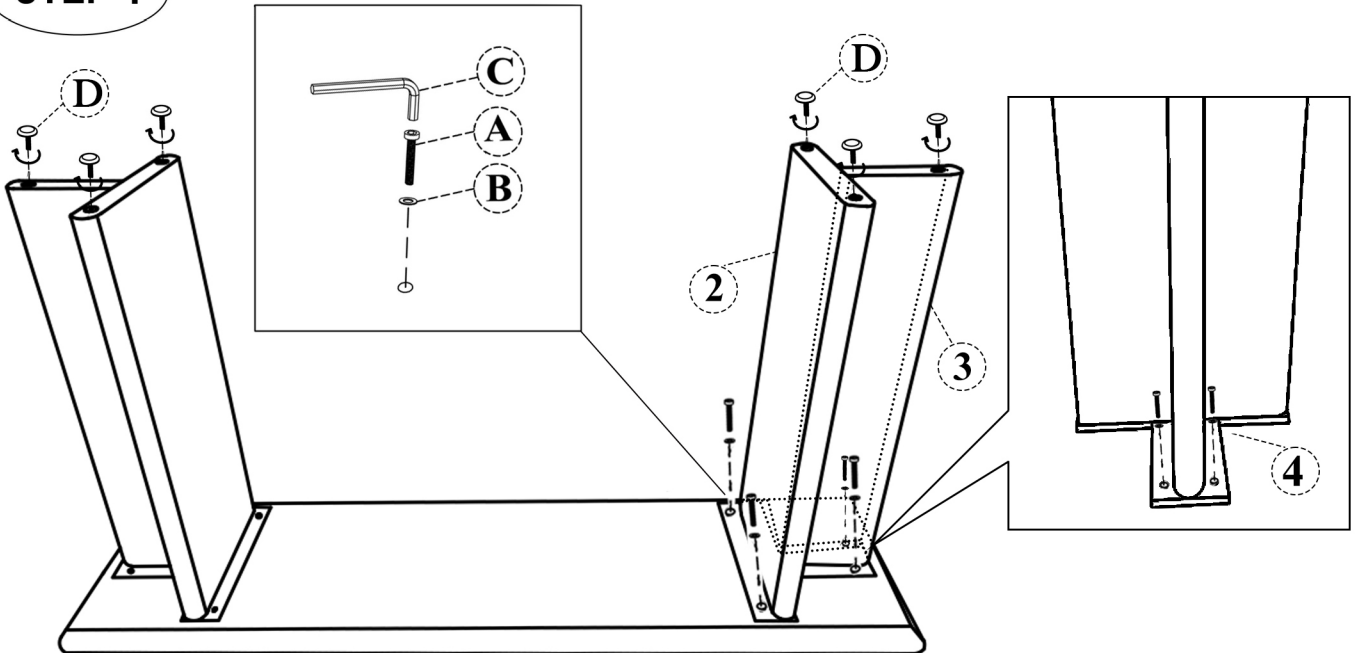

A	Q'ty : 4 pcs	B	Q'ty : 4 pcs	C	Q'ty : 1 pc
					
	Ø8*30mm		Ø13*1mm		

STEP 4



A	Q'ty : 4 pcs	B	Q'ty : 4 pcs	C	Q'ty : 1 pc	D	Q'ty : 6 pcs
							
	Ø8*30mm		Ø13*1mm				

STEP 5

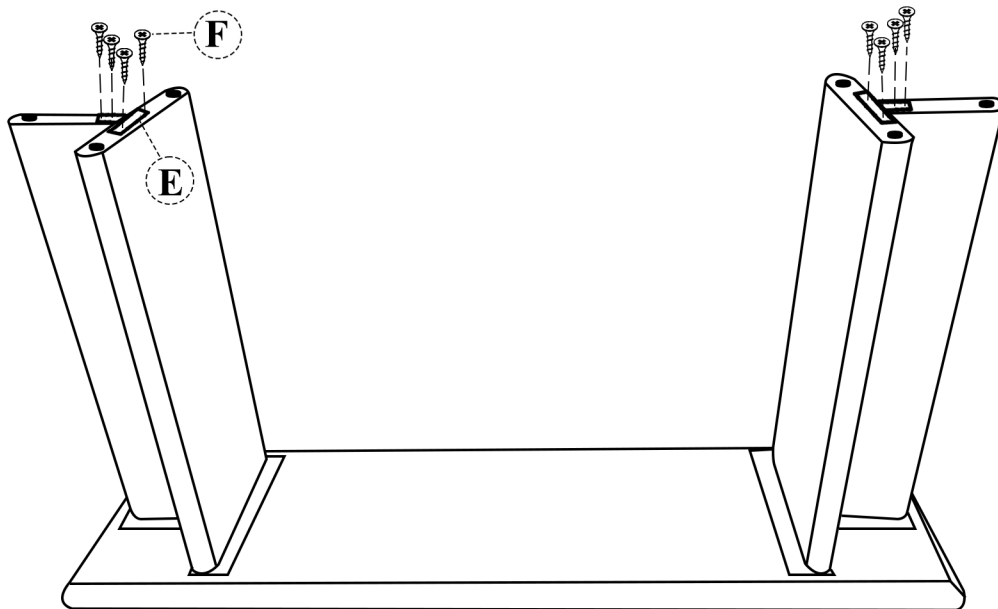

E	Q'ty : 2pcs	F	Q'ty : 8pcs
