

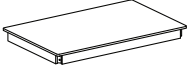





ASSEMBLY INSTRUCTION

DINING TABLE

Thank you for purchasing this product. Please take time to read and follow the instructions below. Check that you have all parts and hardware before assembly. Parts apparently missing are often found in the packing materials. If you do not have all the parts listed, have your dealer contact us and they will be sent to you immediately.

 It is recommended to install protective pads under all legs and supports to avoid damage or scratches when placing furniture on a wood floor or other hard surface, and to limit indentation and prevent discoloration if placing on carpet

PARTS LIST			
A	Table Top		1 pc
B	Legs		4 pcs

HARDWARE LIST			
1	JCBB M8 x 60 MM		9 pcs (Extra 1 pc)
2	Spring Washer M8		9 pcs (Extra 1 pc)
3	Flat Washer M8		9 pcs (Extra 1 pc)
4	Allen Key M5		1 pc

STEP 1

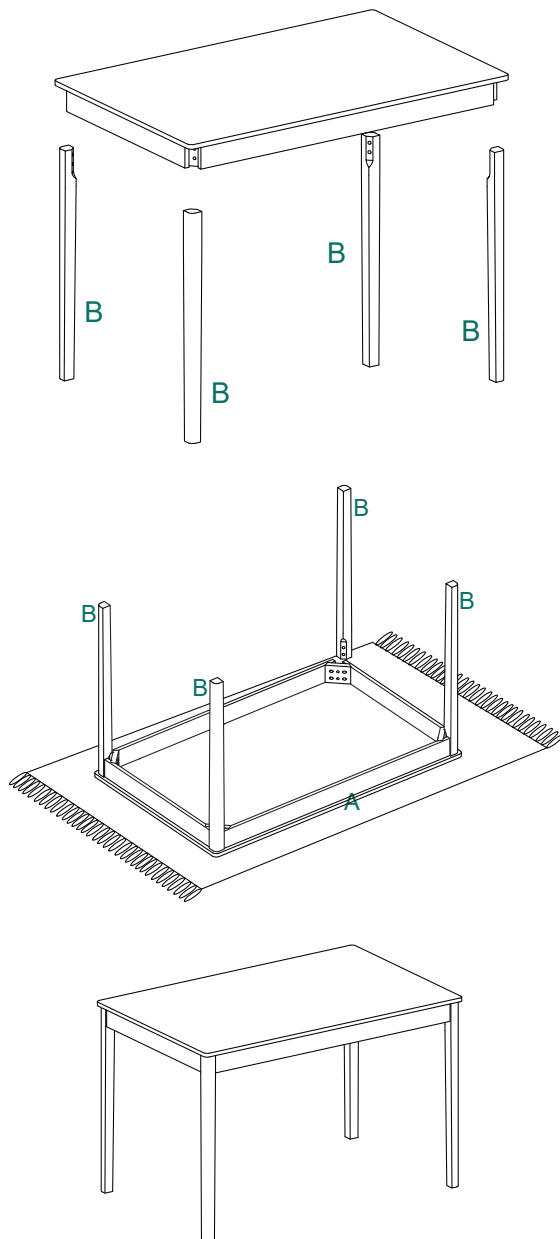

COMPLETED ASSEMBLY

STEP 2

It is recommended that you place paper or cloth on the floor when the Part "A" is in contact with the floor to avoid wear/scratches.

