

LIST OF COMPONENTS

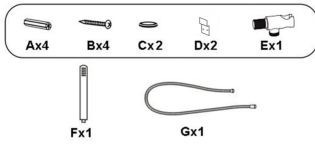

Fx1

Gx1

ELEMENTS FOR INSTALLATION

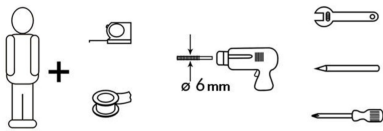

WARNING!

Before testing, please turn on the faucet and leave the water running for about 3 minutes to evacuate the air and dirt trapped in the pipes in order to prevent these residues causing some damage to the shower panel.

INSTRUCTION

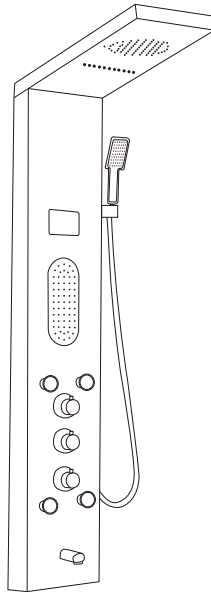

a. screw and nut  
b. tool

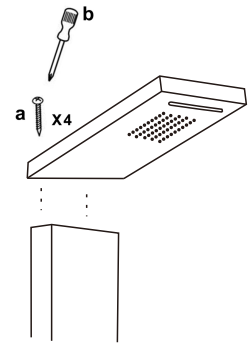

Put the shower head arm into panel body, then tightening the screws

INSTRUCTIONS

WARNING! Before drilling, please make sure there are no pipes or cables in the wall.

I. Drill two holes on the wall

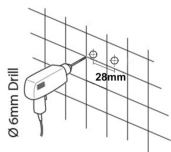

II. Insert the screws into the holes

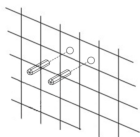

III. Fasten the hooks to the wall with the screws

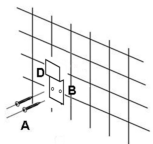

MOUNTING BY WALL

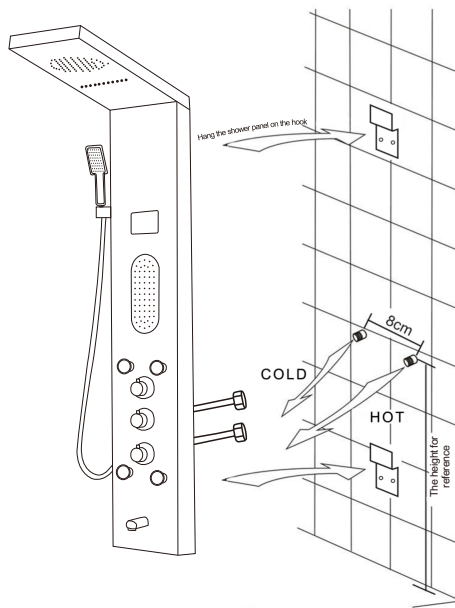

- A Top spray
- B Hand shower
- C Massage back spray
- D Function controller

