

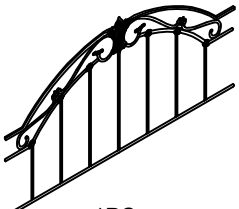









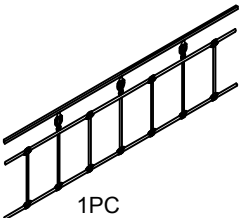

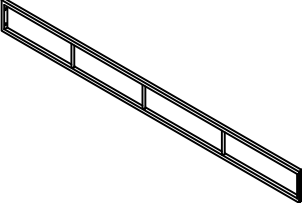
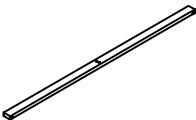



ASSEMBLY INSTRUCTION

METAL HEADBOARD & FOOTBOARD

A Headboard Panel  1PC	B Headboard Post  2PCS	C Footboard Panel  1PC	D Footboard Post  2PCS	E Side Rail  2PCS
F Slat  3PCS	G Support Leg  3PCS	H Finial  4PCS	I Bolt $\phi 5/16" \times 1-3/4"$  8PCS	J Lock Washer $\phi 5/16"$  8PCS
K Flat Washer $\phi 5/16" \times \phi 3/4"$  8PCS	L Plastic Washer $\phi 5/16"$  8PCS	M Bolt $\phi 1/4" \times 1/2"$  8PCS	N Lock Washer $\phi 1/4"$  8PCS	O Flat Washer $\phi 1/4" \times \phi 5/8"$  4PCS
P Camber Washer $\phi 1/4" \times \phi 5/8"$  4PCS	Q Sunk Bolt $\phi 1/4" \times 1-1/2"$  6PCS	R Allen Wrench 5mm  1PC	S Allen Wrench 4mm  1PC	

This page lists all the contents included in the box. Please take the time to identify the hardware as well as the individual components to this product. As you unpack and prepare for assembly, place the contents on a carpeted or padded area to protect them from damage.

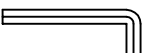
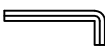
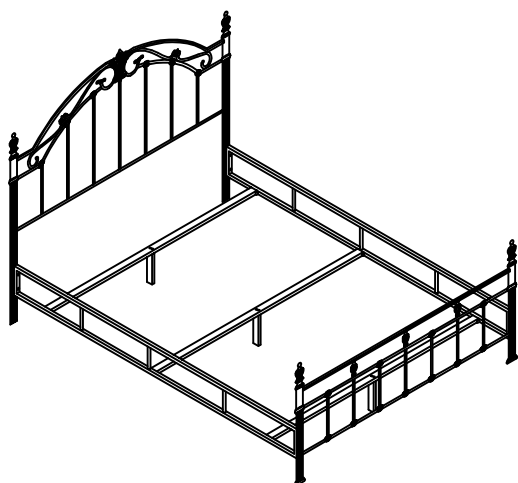

- 1** Use the Bolts (M) with the Lock Washer (N) and Flat Washer (O), Camber Washer (P) to tighten the Headboard Panel (A) with the Headboard Post (B) by 4mm Allen Wrench (S). Directly screw the Finials (H) onto the Headboard Post (B).

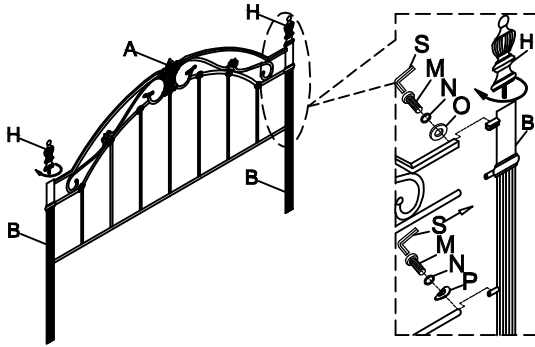

- 2** Use the Bolts (M) with the Lock Washer (N) and Flat Washer (O), Camber Washer (P) to tighten the Footboard Panel (C) with the Footboard Post (D) by 4mm Allen Wrench (S). Directly screw the Finial (H) onto the Footboard post (D).

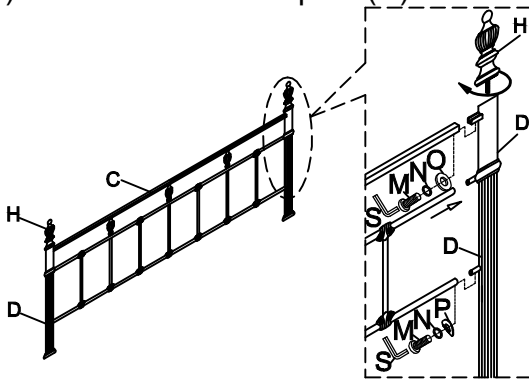

- 3** Use Bolt (I), with Lock Washer (J), Flat Washer (K) and Plastic Washer (L) to connect Side Rail (E) onto Headboard Post (B) and Footboard Post (D), by 5mm Allen Wrench (R).

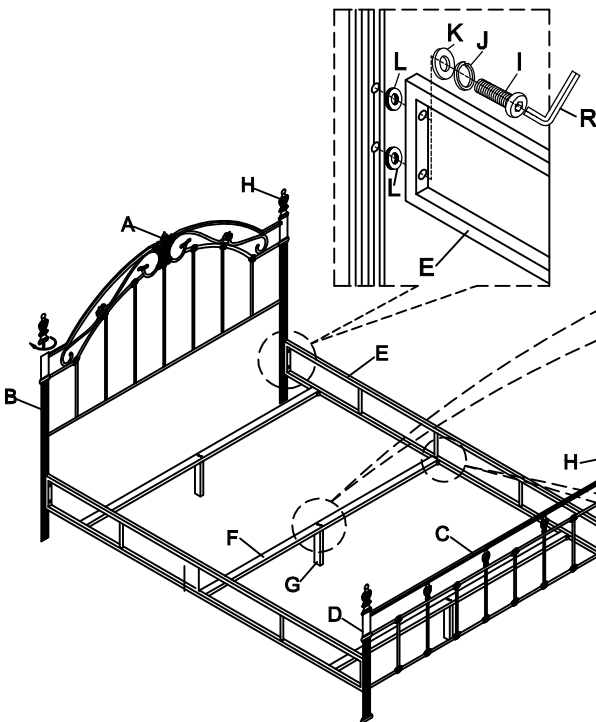

- 4** Use Sunk Bolt (Q) to tighten the Support Legs (G) onto Slat (F), by 4mm Allen Wrench (S).

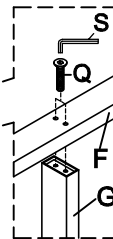

- 5** Make sure the Slats (F) are properly tenoned onto Side Rails (E).

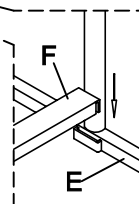

A Short Canopy Bar **B** Long Canopy Bar **C** Footboard Post **D** Headboard Post **E** Canopy Finial

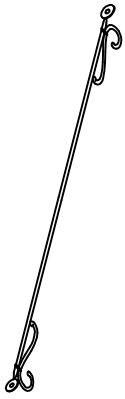

2PCS

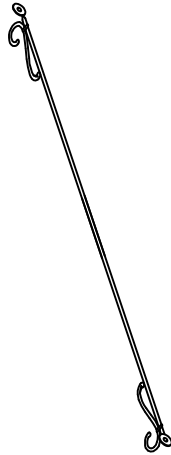

2PCS



2PCS



2PCS



4PCS

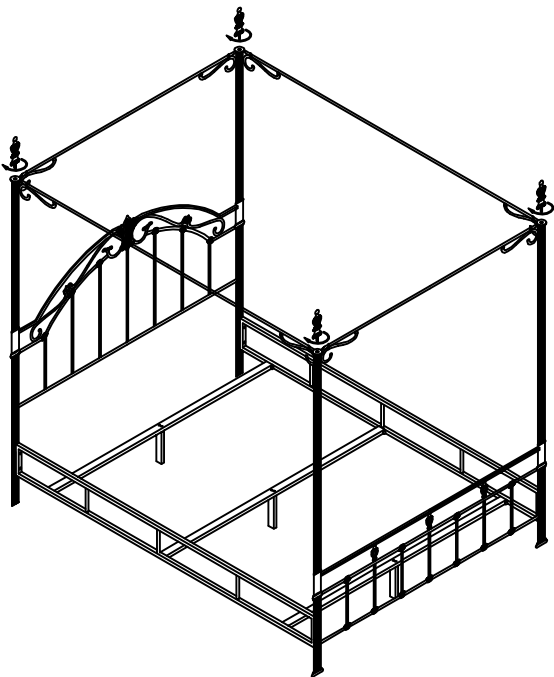

This page lists all the contents included in the box. Please take the time to identify the hardware as well as the individual components to this product. As you unpack and prepare for assembly, place the contents on a carpeted or padded area to protect them from damage.

- 1** Screw to connect Headboard Post(D) with Headboard. Screw Canopy Finial (E), through Long Canopy Bar (B) and Short Canopy Bar (A) onto Headboard Posts (D) & Footboard Post (C).

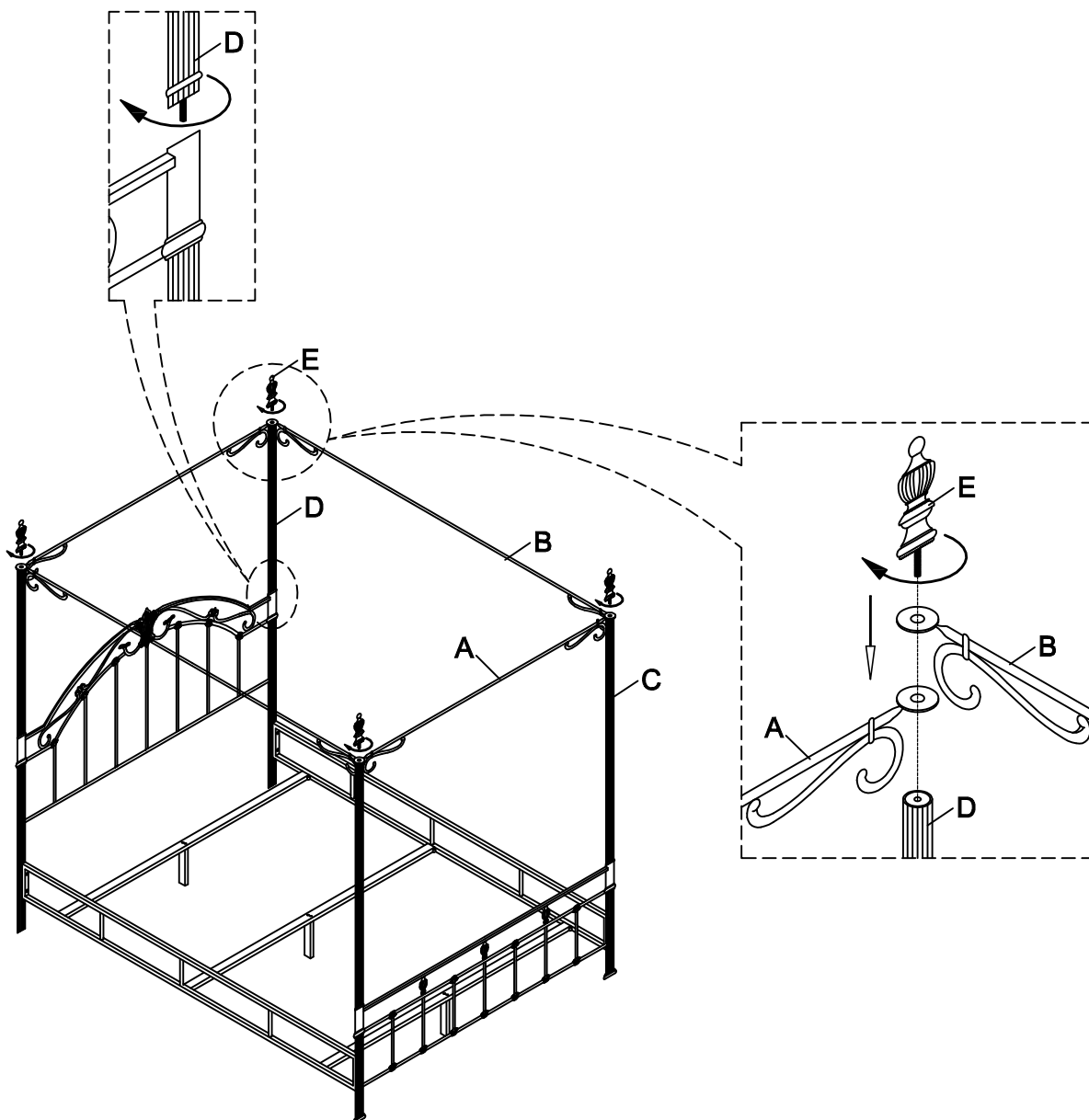

Cleaning & Care

Treat surface with care. Surface is resistant to scratches but is not scratch resistant. Clean surfaces with a dry or damp soft cloth. Do not use abrasive cleaners. Hardware may loosen over time. Periodically check that all connections are tight.