

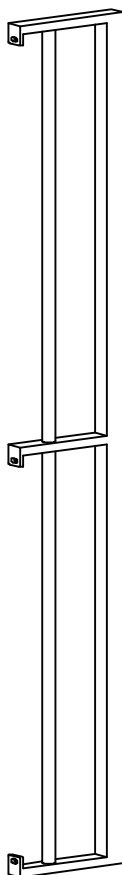



# Wide Extension kit

## Instruction Manual



# PARTS LIST



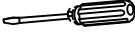

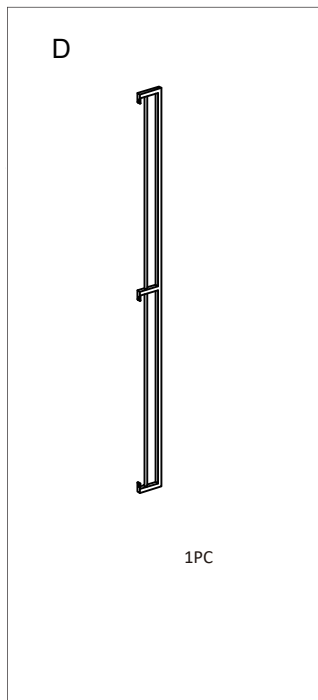
- Carefully remove all the parts from the carton and place them individually on a soft cloth to prevent scratches or other damage.
- Carefully and strictly follow these assembly&installation instructions to ensure a completed product as designed.
- Do not tighten all the screws until each part is properly assembled.

1  M6*12 3PCS	2  M4 1PC	3  3m self-adhesive pad 5PCS	4  Philips head screwdriver 1PC		
---	---	--	---	--	--



Other accessories that are not in the accessories list are not included. They are only used to demonstrate how to use the Wide Extension Kit .



# STEP 1

Required Tools	B	D	1
			
	1PC	1PC	3PCS
			2
			
			1PC

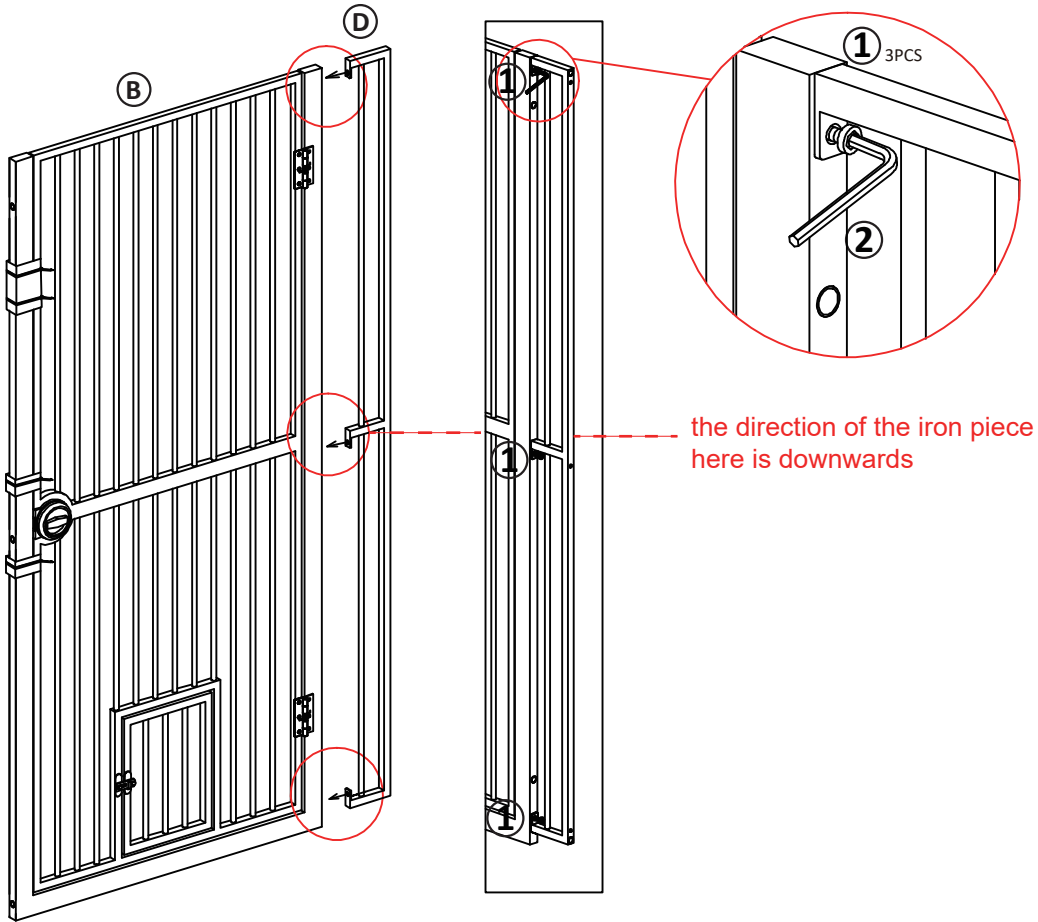
You can purchase multiples of this piece and follow this step installation method to widen it to fit the width of your door.



# STEP 2

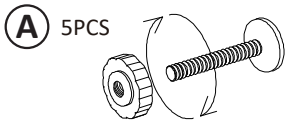

Required Tools	A	B+D	3
			
	5PCS	1PC	5PCS

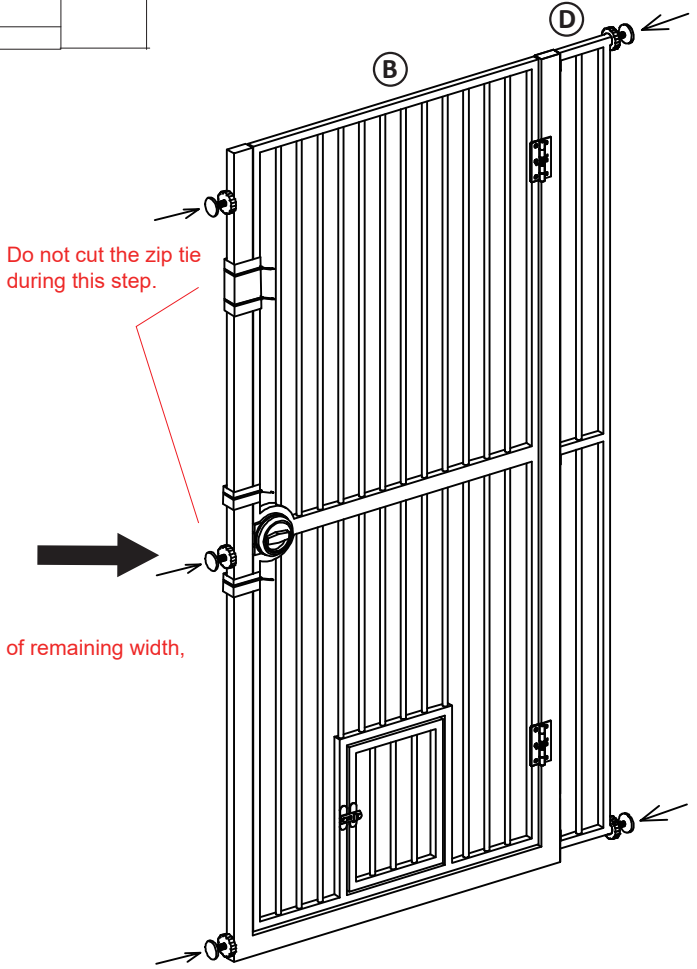

Rotate until there is about 1.58 inches of remaining width, tear off one side of (3) and stick it

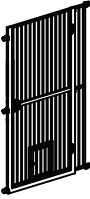

# STEP 3

Required Tools	A+B+D 	4 
	1PC	1PC

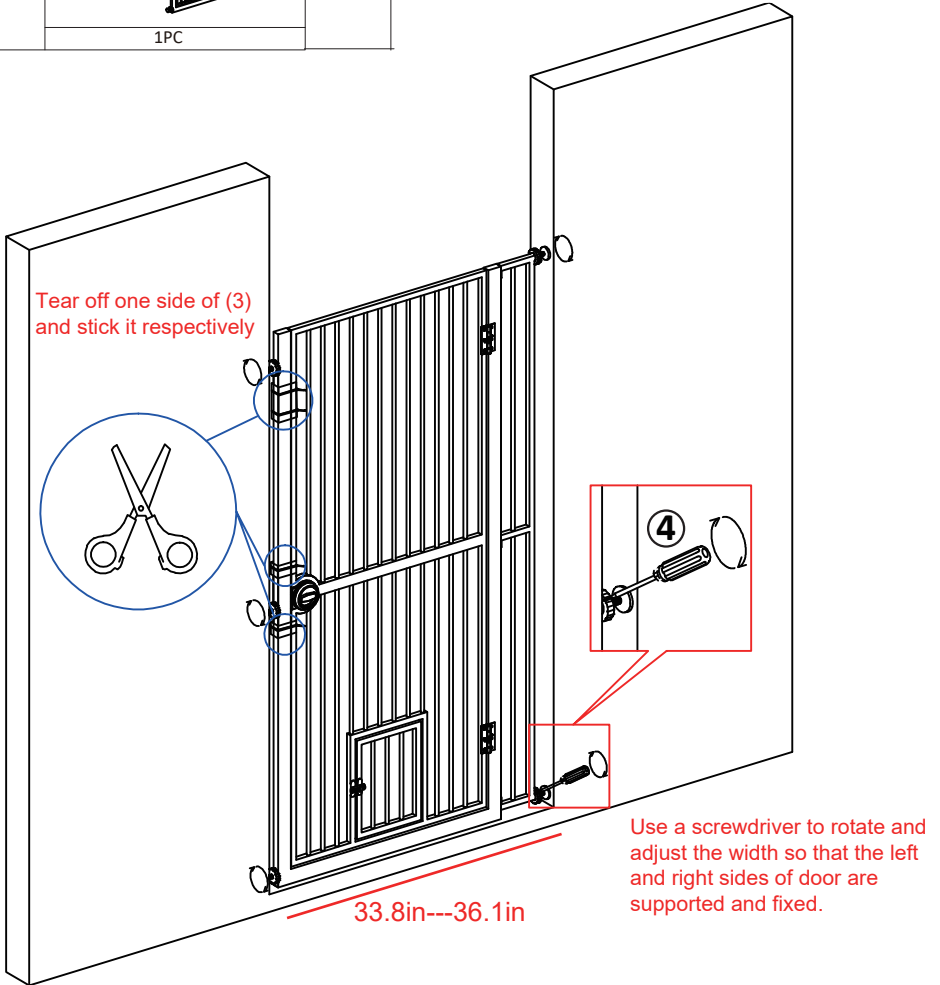

# AFTER-SALES SERVICE CARD

We sincerely thank you for trusting our service and our products, and may this product add enrichment to your home. We guarantee that the product has undergone strict quality inspection and meticulous packaging. If you encounter any issue regarding either shipping or the product, please feel free to contact us at any time. We'd be more than happy to serve you wholeheartedly.

Yours Sincerely

- Please avoid harsh, corrosive and abrasive cleaners.
- Keep dry and avoid damp environments.

---

If you have any questions or concerns please feel free to contact us. We're committed to providing our customers with the quality service.