

Installation & Assembly

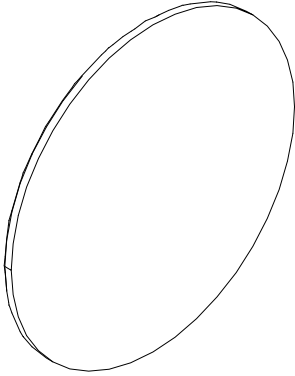

530x530
20.9x20.9

Ax1

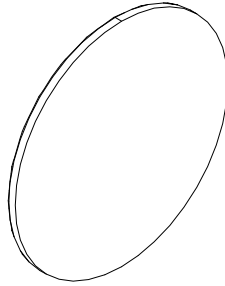

398x398
15.7x15.7

Bx1

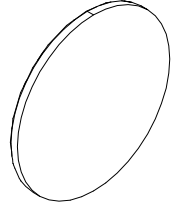

285x285
11.2x11.2

Cx1

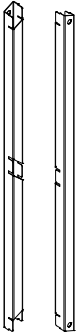

429.1x15
16.9x0.6

Dx12

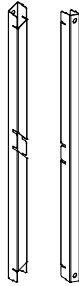

362.8x15
14.3x0.6

Ex12

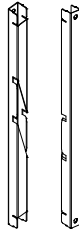

289.9x15
14.3x0.6

Fx12

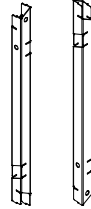

267.3x15
10.5x0.6

Gx12

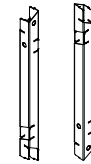

202.3x15
8.0x0.6

Hx12

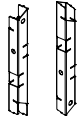

144.8x15
5.7x0.6

Ix12



Jx90



Kx90



Lx18



Mx1



€ \$ £



mm
inch

x2

1

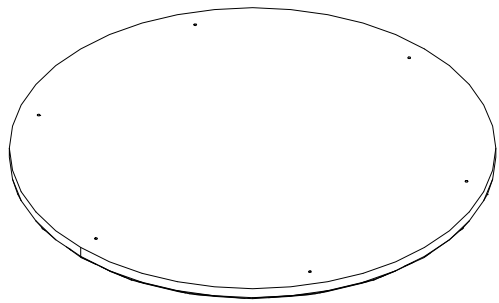
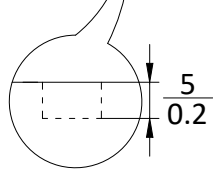
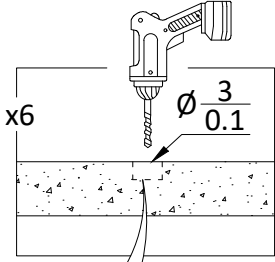
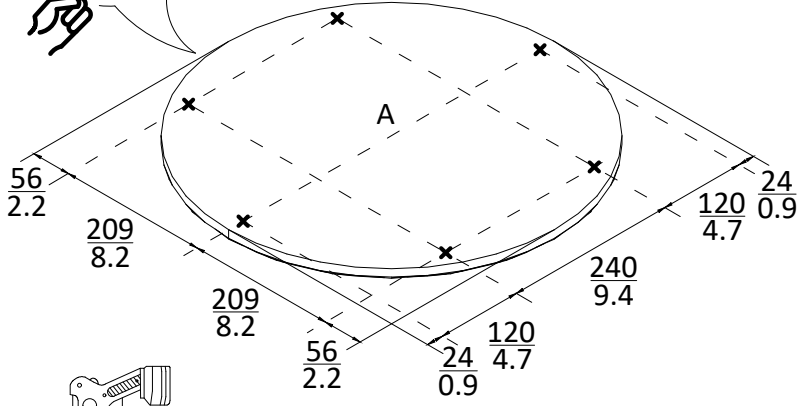
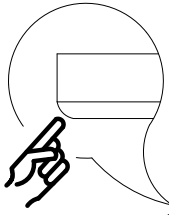

a

2

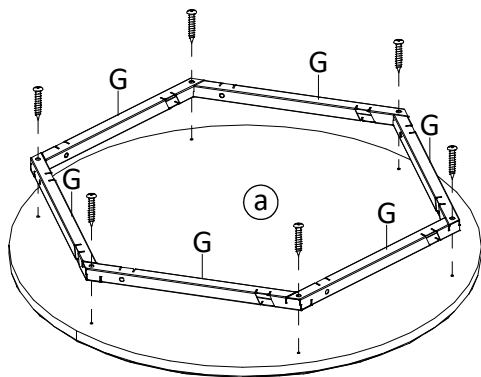
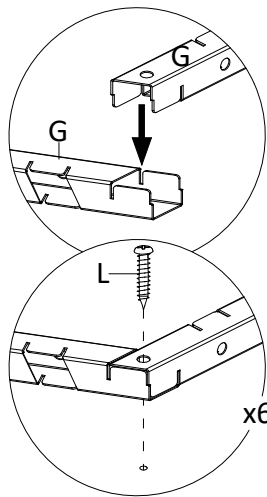

Lx6

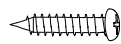

3

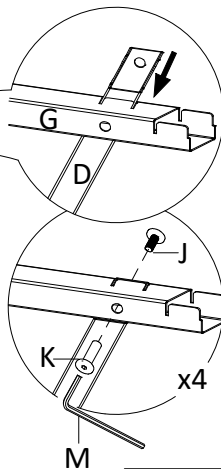
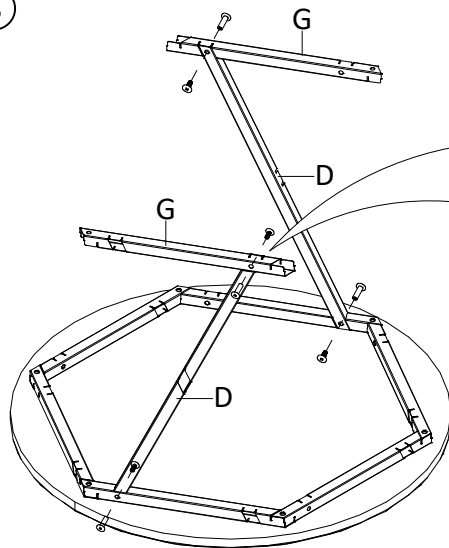

Mx1



Jx4



Kx4



4

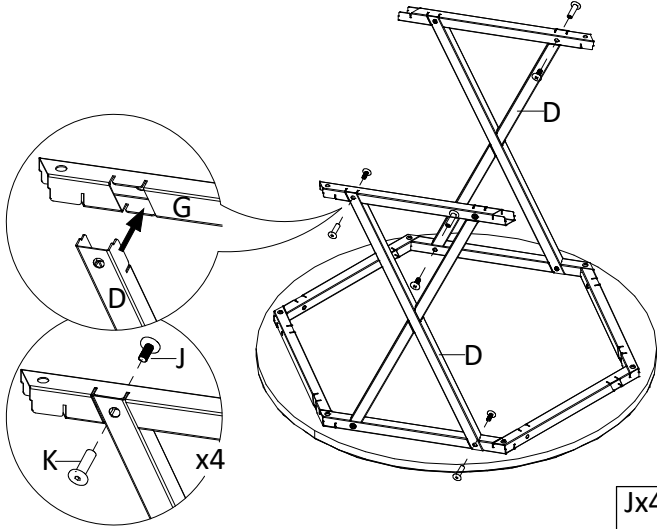

Jx4



Kx4



5

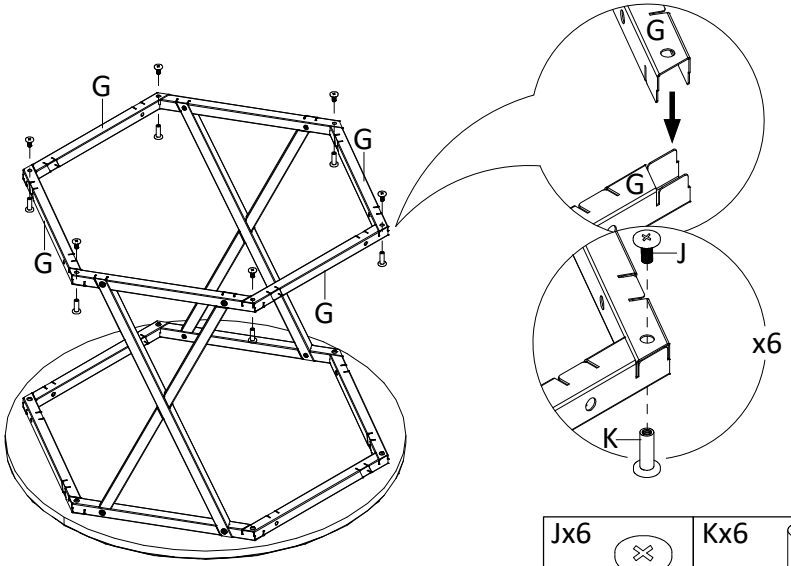

Jx6



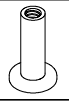

Kx6



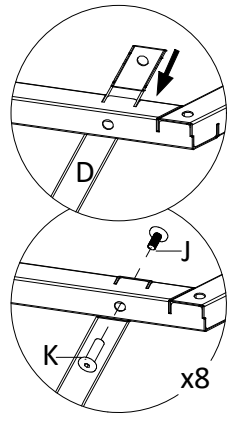
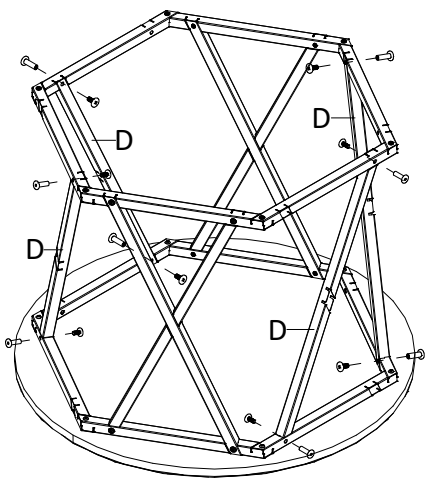

6

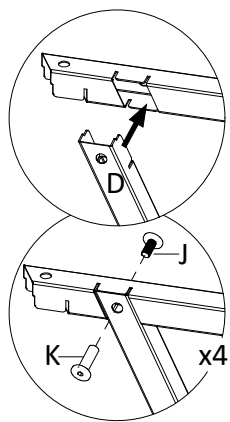
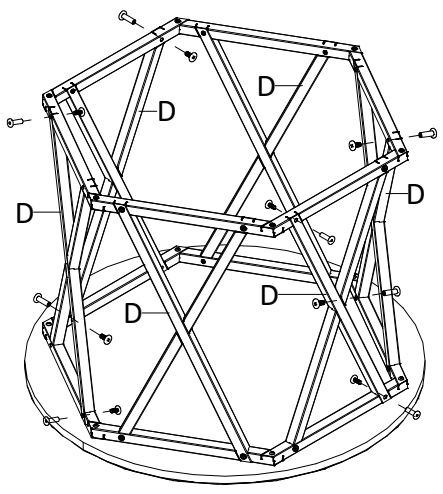

Jx8	
Kx8	

7



Jx8	
Kx8	

8

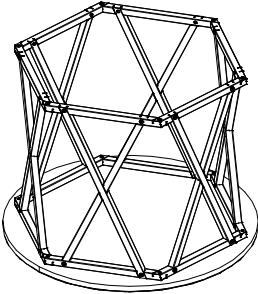

180°



b

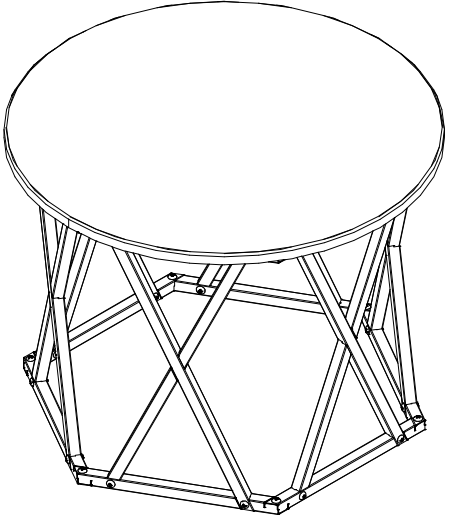

9

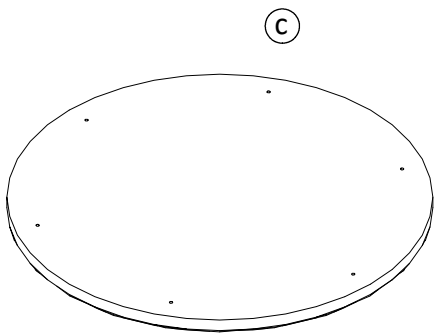
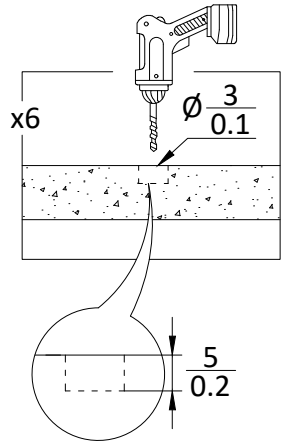
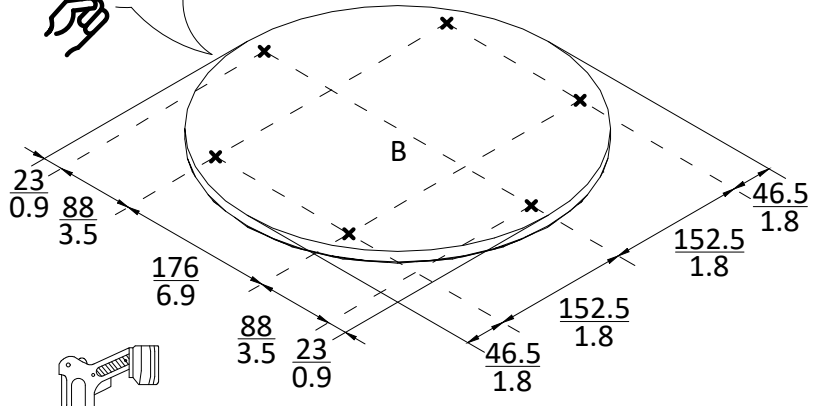
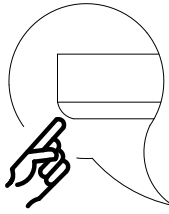

10

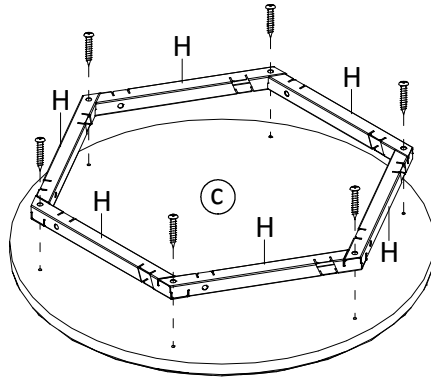
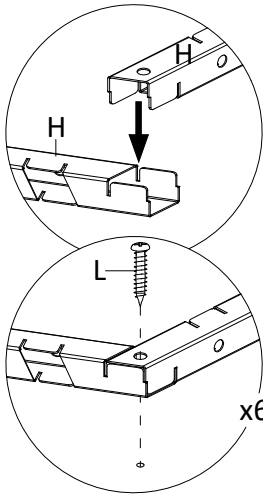

Lx6

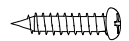

11

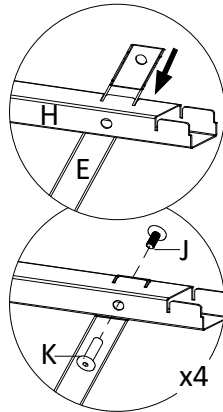
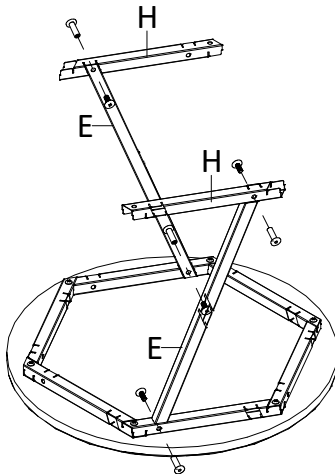

Jx4



Kx4



12

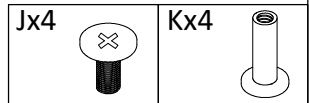
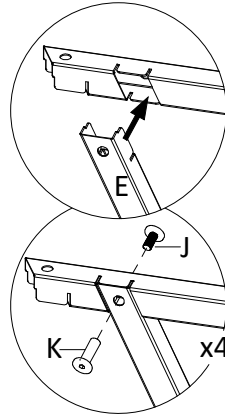
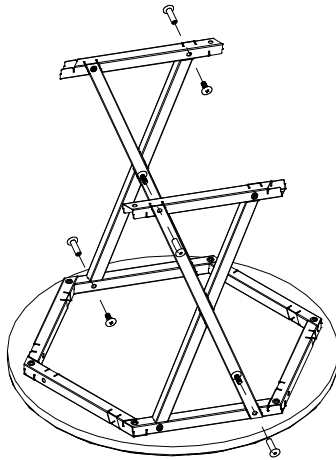

13

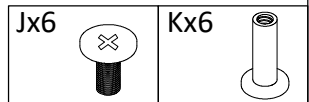
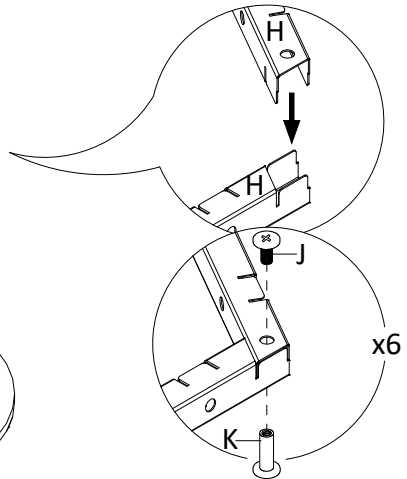
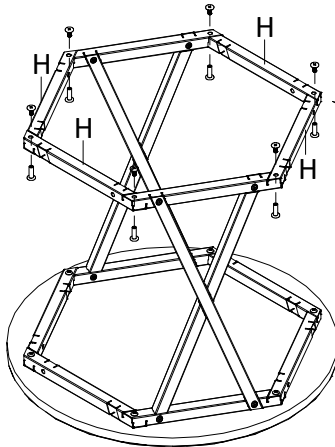

14

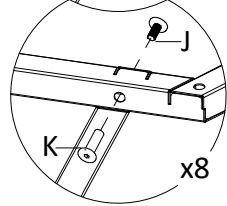
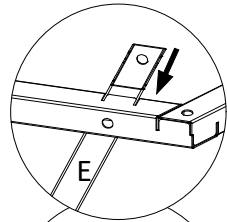
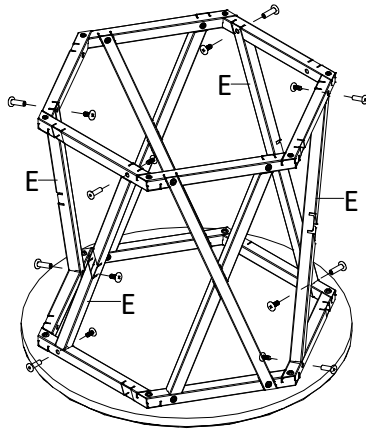

Jx8



Kx8



15

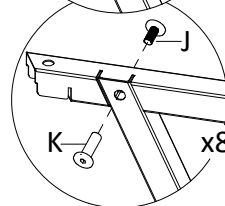
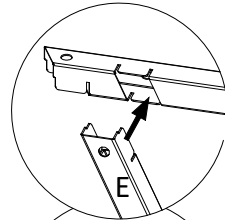
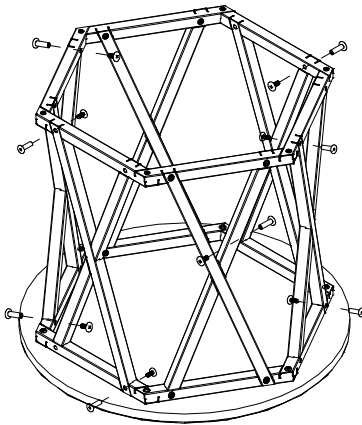

Jx8



Kx8



16

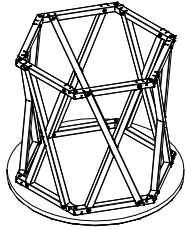

180°



d

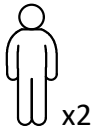
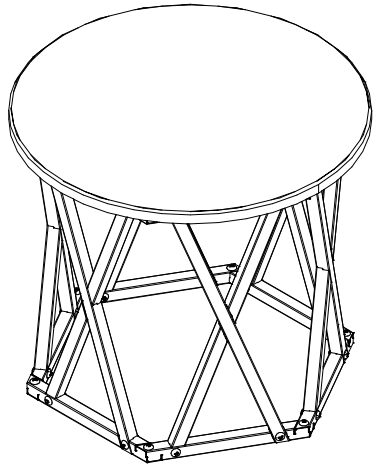

17

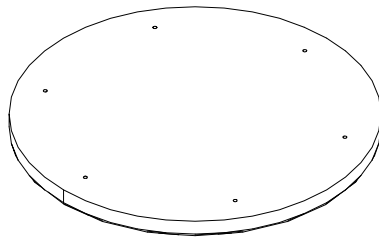
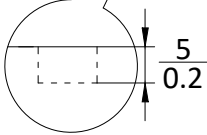
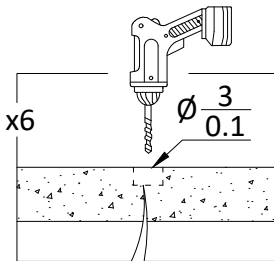
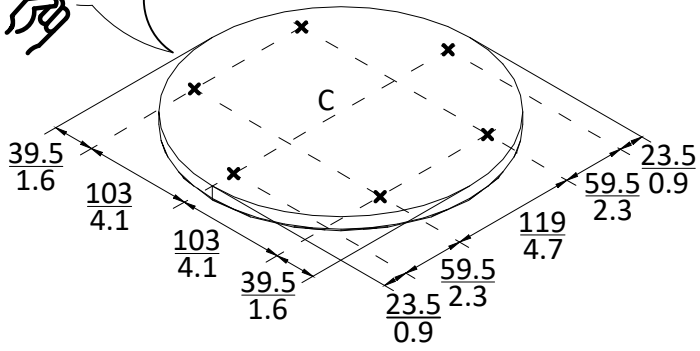
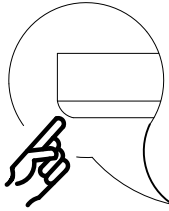

e

18

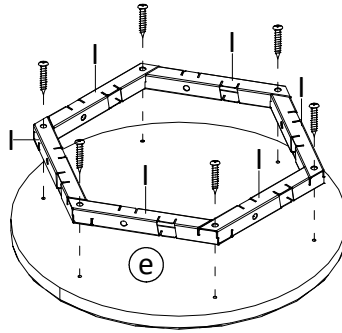
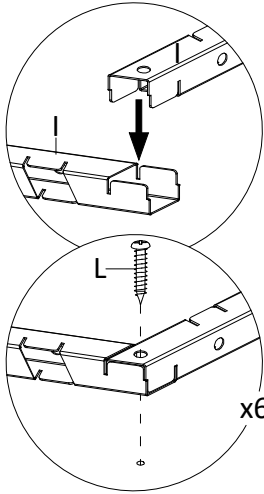

Lx6

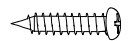

19

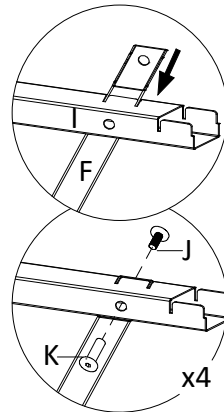
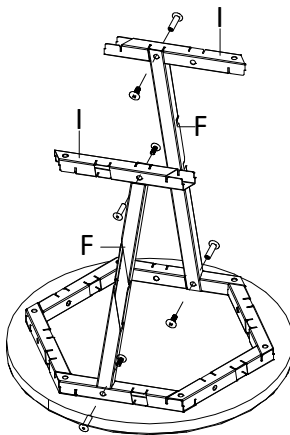

Jx4



Kx4



20

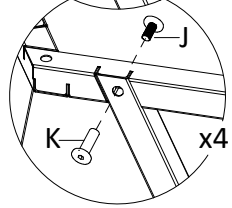
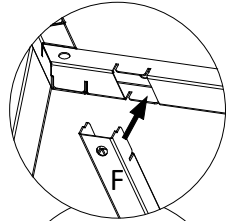
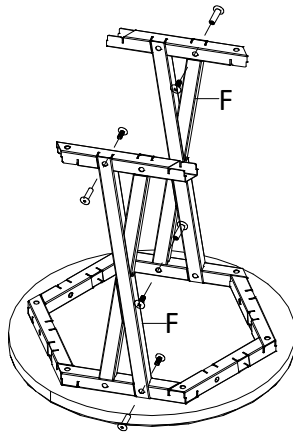

Jx4



Kx4



21

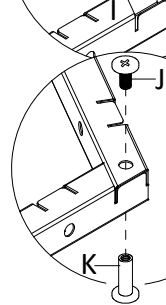
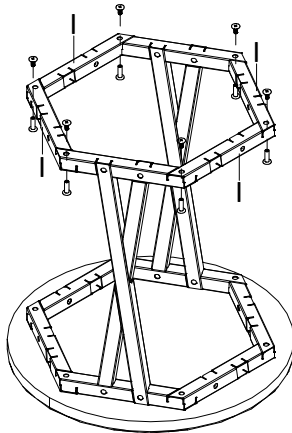

Jx6



Kx6



22

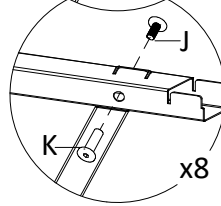
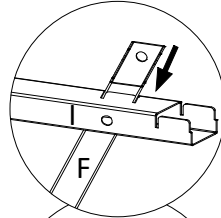
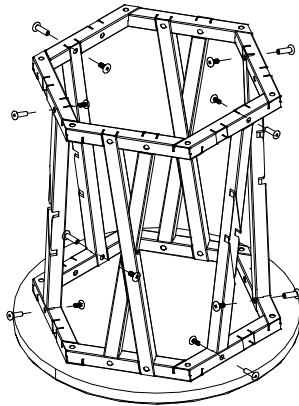

Jx8



Kx8



23

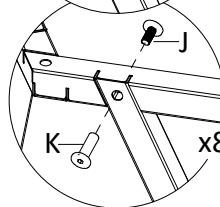
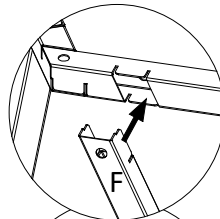
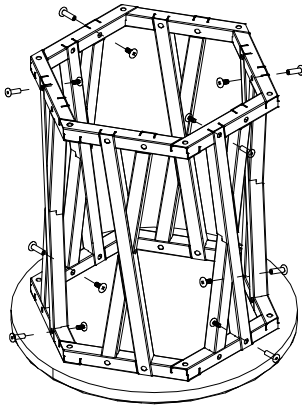

Jx8



Kx8



24

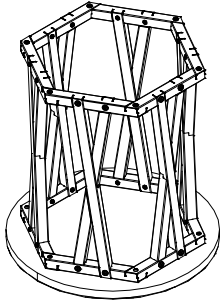

180°



f

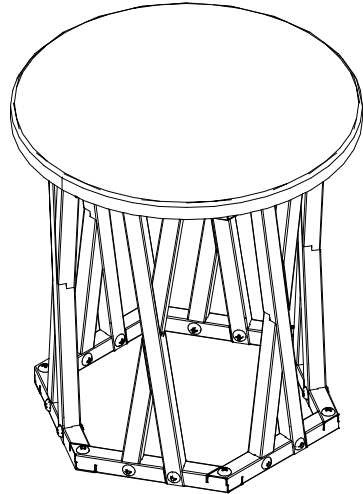

25

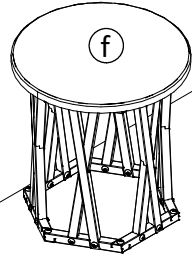
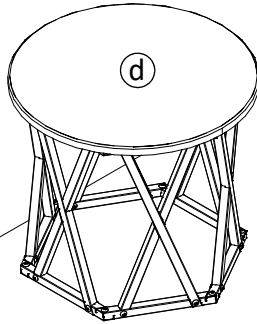
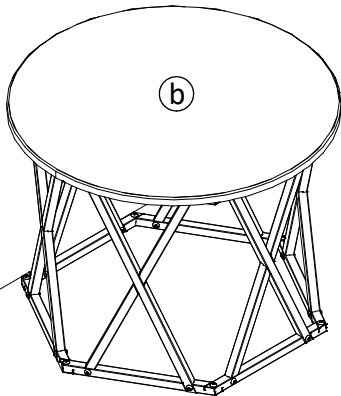

26

