











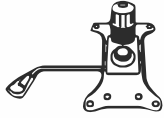

Assembly instruction

Please read this manual carefully before any operation and keep it properly for future use.

Accessories List

(A) Backrest 	(B) Seat Cushion 	(C) Base Plate 	(D) Air Rod 	(E) Steel Plate 
(F) Central Base Tube 	(G) Split Base Tube x5 	(H) Castor x5 	(I) Central Base Buckle 	(J) Screws M6x14mm*10 
(K) Screws M6x20mm*7 	(L) Screws M6x20mm*4 	(M) Hexagon Wrench 		

Notice

1. Do not stand in this chair or use the chair as a step ladder, use it as chair only.
This chair is designed for one person to use at a time.
2. Do not use this chair unless all bolts, screws and knobs are firmly secured.
3. Check all bolts, screws and knobs every 90 days. Tighten them if any are loose.
4. Failure to follow these instructions may result in serious injury or death of yourself and people around you
5. Some of the parts are heavy and/or have sharp edges, please install it carefully to avoid hurting you and people around you

Instruction for Use



Upward/ Downward Adjustment

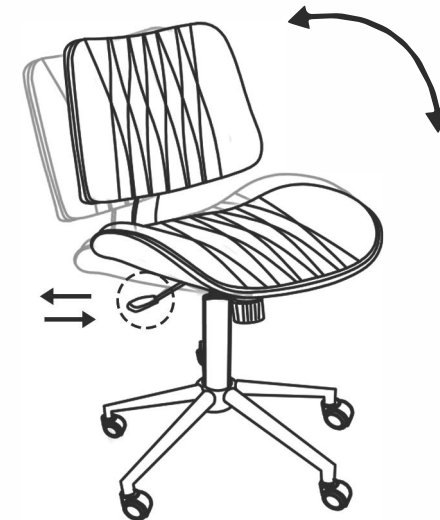

Rocking Function

Assembly Instruction

Please assemble in a wide and flat place.

Step 1

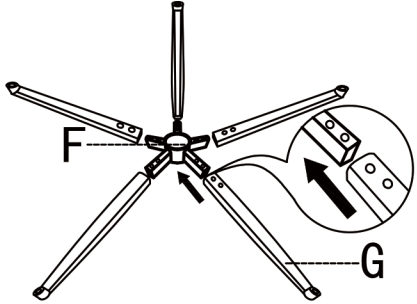

Step 2

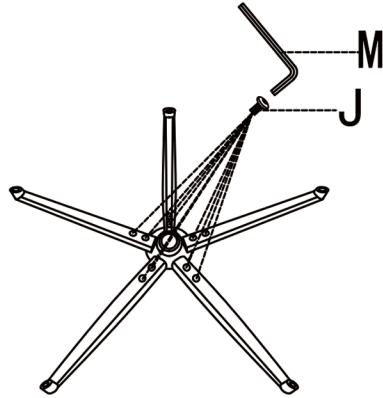

Step 5

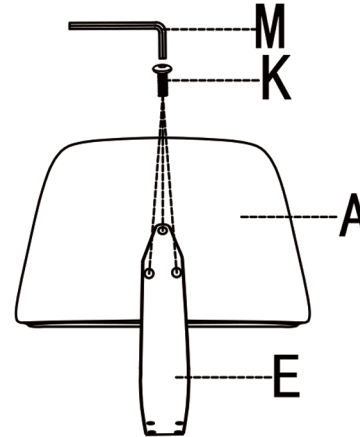

Step 6

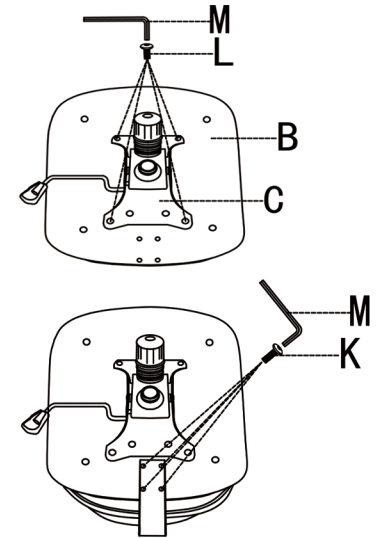

Step 3

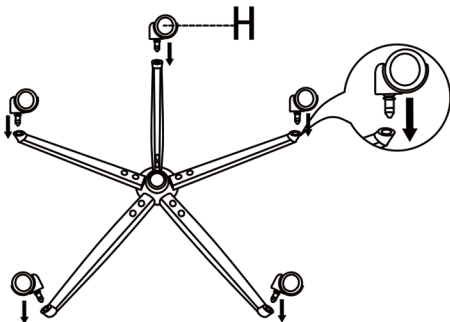

Step 4

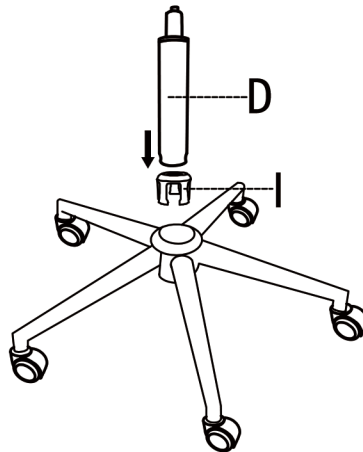

Step 7

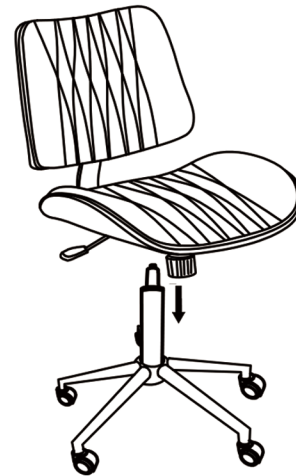

Step 8

