

## Outdoor Wicker Sectional Corner Chair

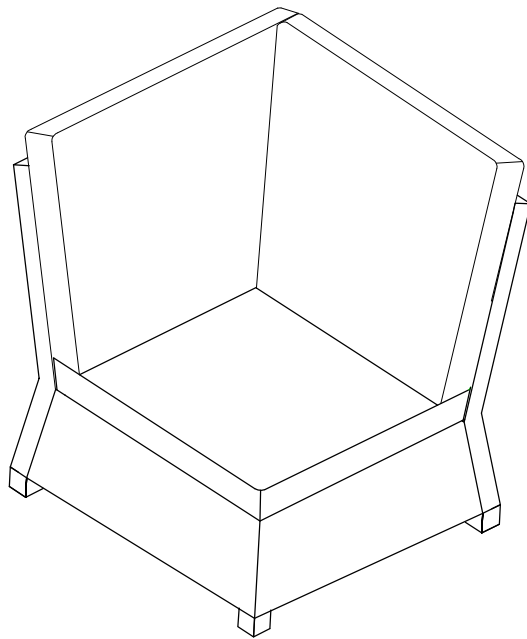







We strive to provide fine furniture products, built with quality materials and hand finished details. Please carefully follow the assembly instructions to ensure your furniture is assembled correctly to provide long lasting enjoyment.

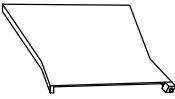
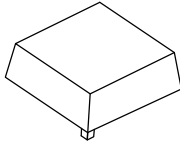
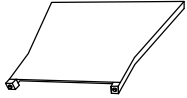
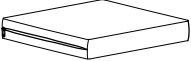



Should you experience any missing or damaged parts **do not return to the store.**

**Care: Use a soft, clean cloth that will not scratch the surface when cleaning. The use of solvents is not necessary. Should you choose to use solvents, test in an inconspicuous area first to avoid damaging the finish. To clean, simply use a soft, clean cloth lightly dampened with water.**

**PART LIST**

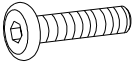
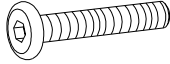
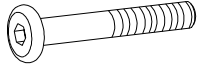
					
Left Arm Panel		Seat Panel		Right Arm Panel	
A	1PC	B	1PC	C	1PC
					
Cover Of Seat Cushion		Inner Of Seat Cushion		Cover Of Back Cushion	
D	1PC	E	1PC	F	1PC
					
Inner Of Back Cushion		Cover Of Back Cushion		Inner Of Back Cushion	
G	1PC	H	1PC	I	1PC

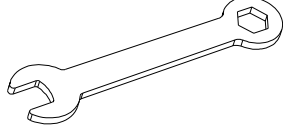
**HARDWARE LIST**

					
Short Bolt(M6*55mm)		Medium Bolt(M6*65mm)		Long Bolt(M6*85mm)	
J	5PCS	K	4PCS	L	1PC
					
Nut(M6mm)		Washer(M6mm)		Wrench(M6mm)	
M	4PCS	N	14PCS	O	1PC
					
Allen Key(M6mm)					
P	1PC				

**EXTRA HARDWARE LIST**

				
J X1PC	K X1PC	L X1PC	MX1PC	N X3PCS

**Step 1.** Lay Right Arm Panel (C) down on a flat surface. Attach Seat Panel(B) to Right Arm Panel(C) using the Short Bolts(J), Medium Bolts(K), Nuts (M), Washers(N), Wrench(O) & Allen Key (P).

NOTE: Please do not fully tighten bolts until unit is fully assembled.

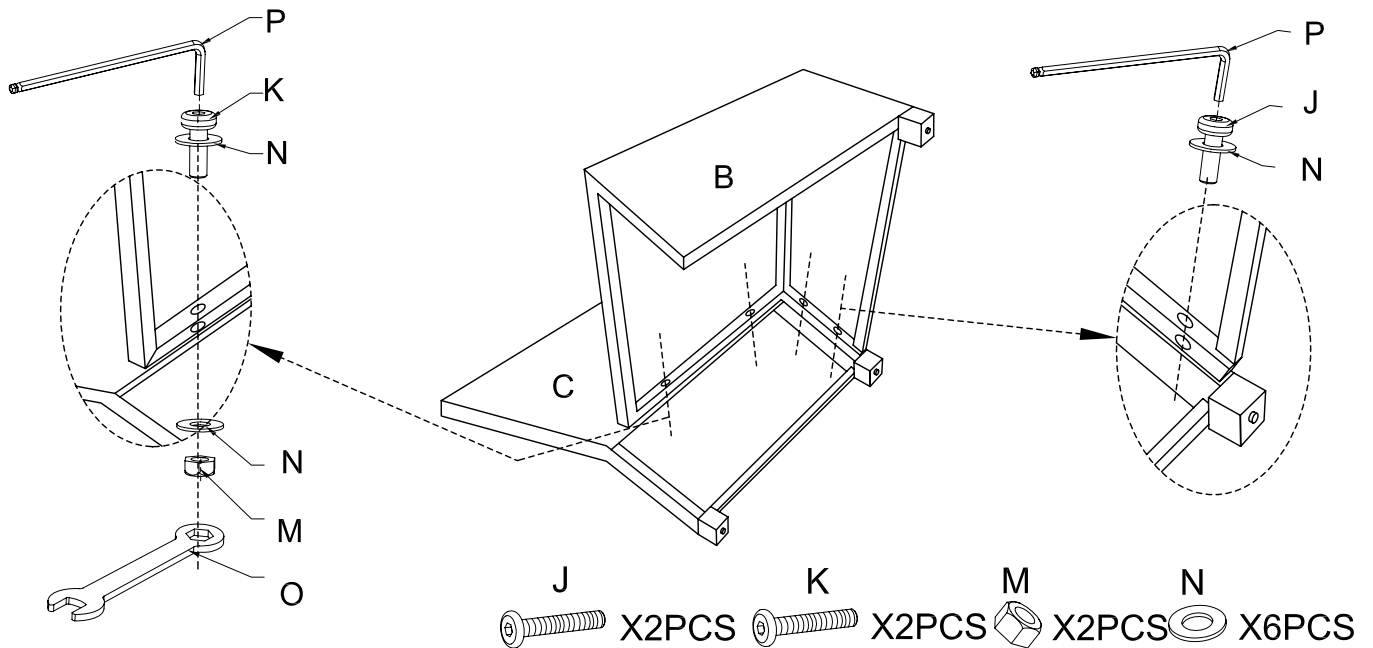

**Step 2.** Attach Left Arm Panel(A) to Right Arm Panel(C) and Seat Panel (B) using the Short Bolts( J), Medium Bolts(K), Washers(N), Nuts(M), Wrench (O) & Allen Key (P).

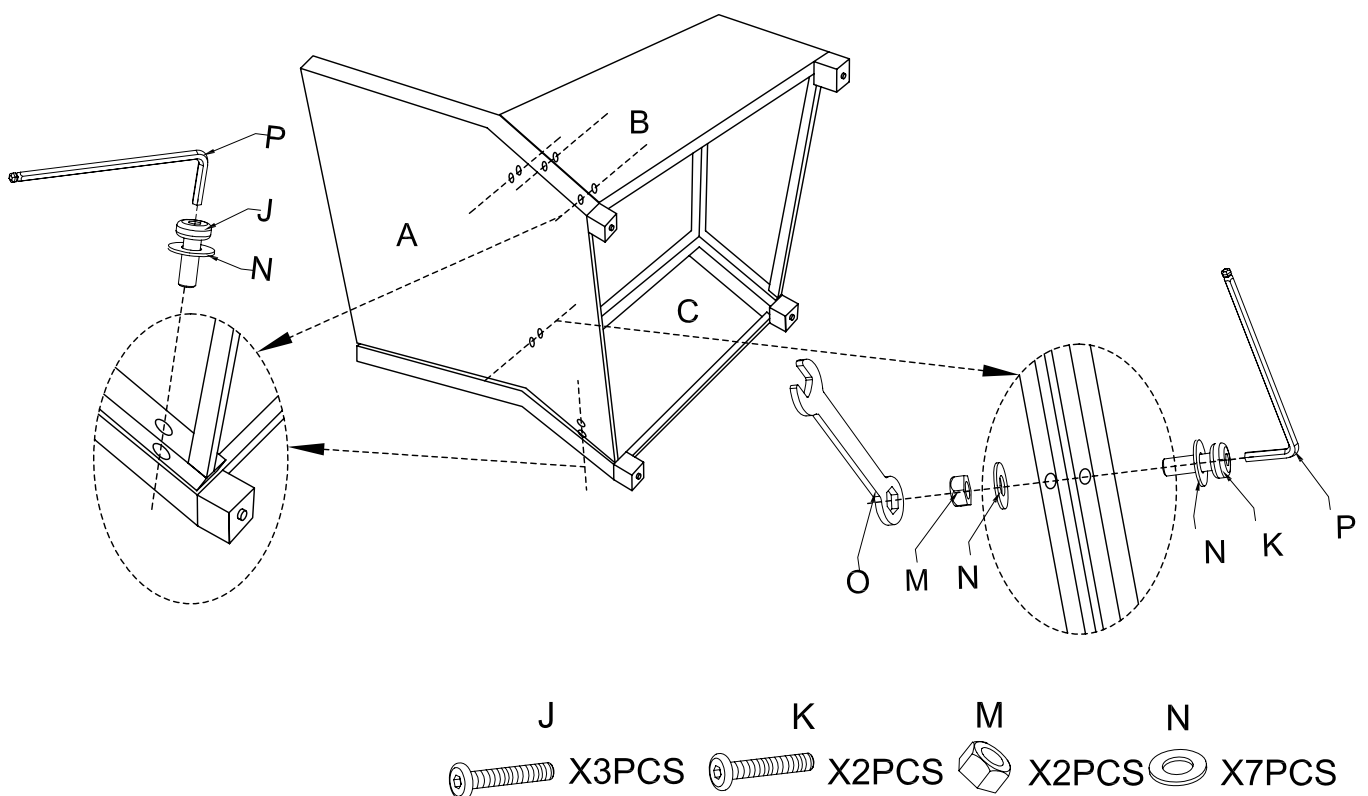

**Step 3.** Attach Right Arm Panel(C) to Left Arm Panel(A) using the Long Bolts( L),Washers(N) & Allen Key (P).

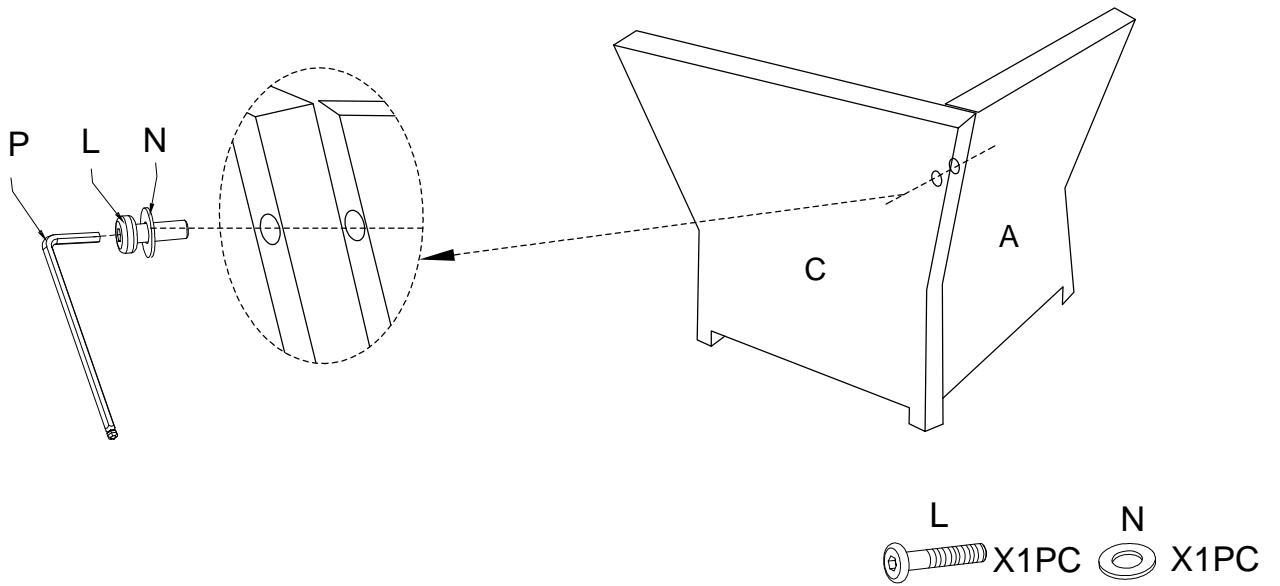

**Step 4.** Insert Inner Of Seat Cushion (E) into Cover Of Seat Cushion (D).  
Insert Inner Of Back Cushion (G) into Cover Of Back Cushion (F).  
Insert Inner Of Back Cushion (I) into Cover Of Back Cushion (H).

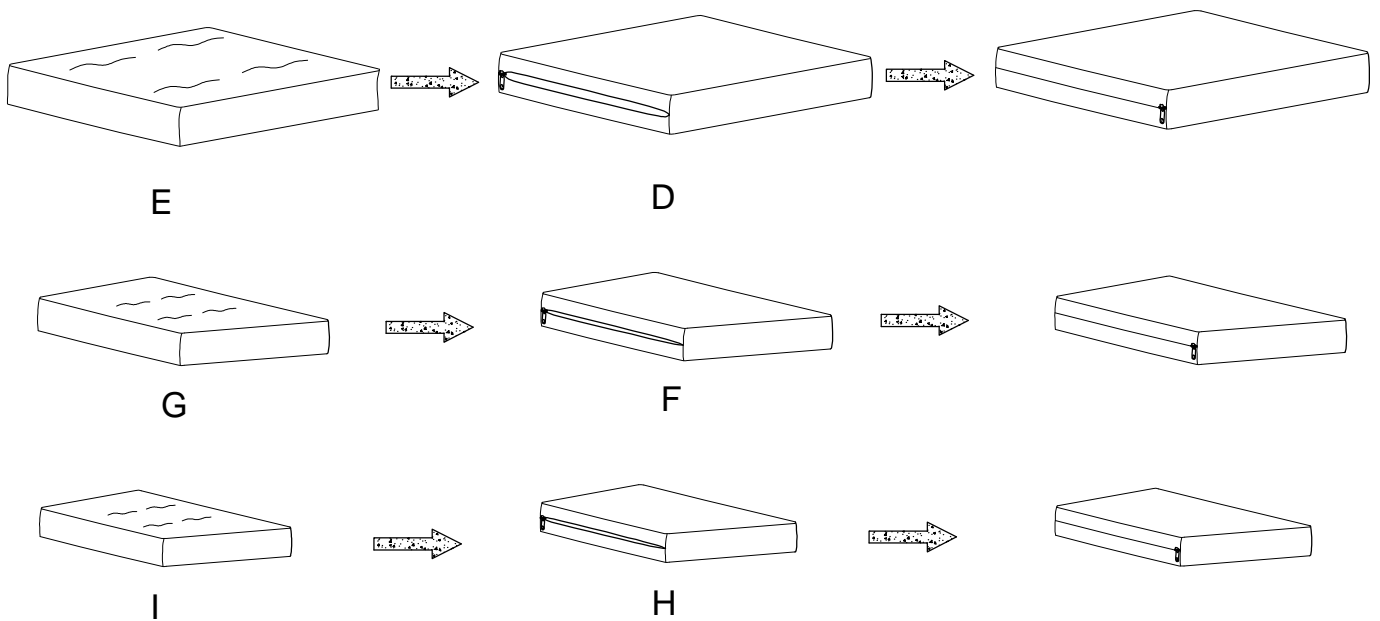

**Step 5.** Place Seat Cushion and Back Cushion on the chair.

