

THANK YOU

We would like to take this opportunity to thank you for choosing Novatto. We hope you are truly satisfied with our product(s) and enjoy it for years to come. As a small business, we learn the most from you, the customer. Please visit the link below to leave us a review and we'll reward you with a \$25 Amazon or Visa gift card.

It's easy as...

- Go to novattoinc.com
- In the top left, click "product registration and review"
- Find your product model
- Review, submit... enjoy!

Please Note:

- Unpack the box and ensure all parts are included.
- Review and abide by all building and plumbing codes.
- Novatto drains need to be installed by a professional.

INSTALLATION INSTRUCTIONS

- **Disassemble drain** and save ALL components.
- **Place the vessel** on top of the counter and make sure the drain fits down inside of the counter. If a mounting ring is used, place it under the sink. The mounting ring will elevate the sink 1/2" and provide stabilization.
- **Use bead** of silicone to seal between exterior of vessel where it is mounted to the mounting ring or counter.
- **Use a level** to ensure the vessel is level in every direction and install the drain.
- **Align drain** of the sink and tail pipe then partially thread drain body to tail pipe.
- **Connect tail pipe** to plumbing then firmly thread drain to tail pipe.
- **Secure the vessel** to the counter with fastener on the drain. Be sure to not over tighten the drain assembly. Hand tightening will be sufficient.

ASSEMBLY

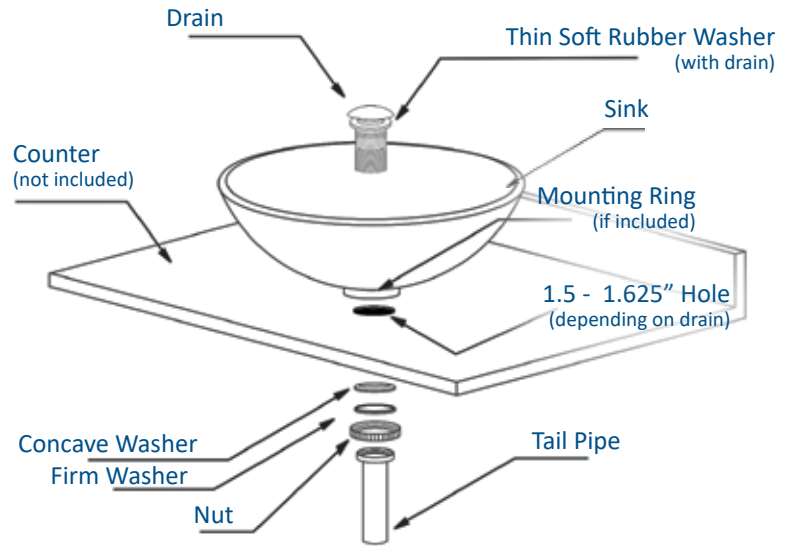

DO NOT OVER TIGHTEN THE DRAIN!

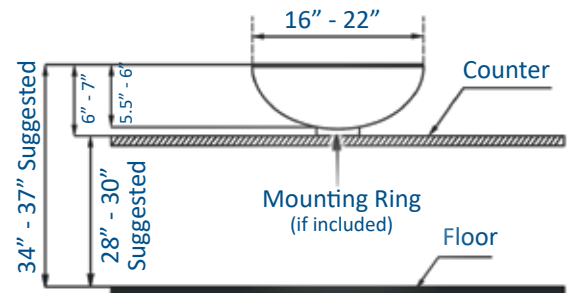
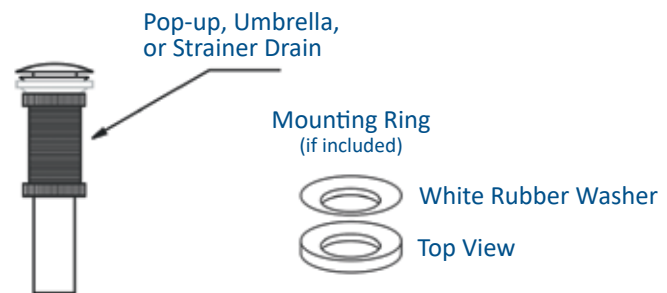

TOOLS NEEDED FOR ASSEMBLY

(not included)



Questions, problems, missing parts? Before returning, call our customer service department at 844.404.4242, 8:00 a.m. - 5 p.m., MST Monday - Friday or e-mail us at: support@novattoinc.com

TROUBLESHOOTING TIPS

Issue	Reason	Solution
Sink wobbles or is loose	Mounting ring not used; drain is loose	Use mounting ring with silicone; tighten drain
Does not completely drain	Pop-up is too high; wrong seal used	Make sure correct seal is used and is below bevel
Leakage under sink	Drain has come loose	Tighten the fastener under the countertop

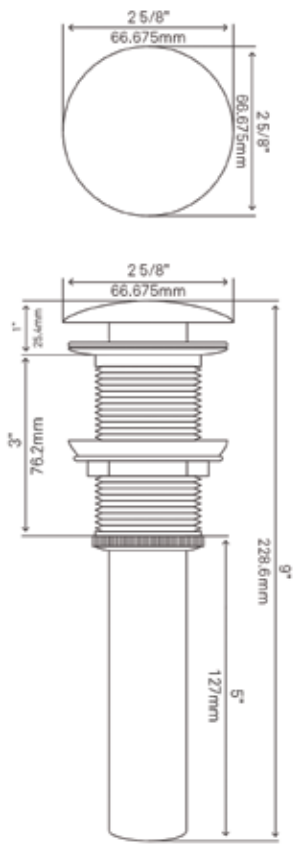

Pop-up Drains (w/o Overflow):
 PUD-BN • PUD-CH • PUD-ORB

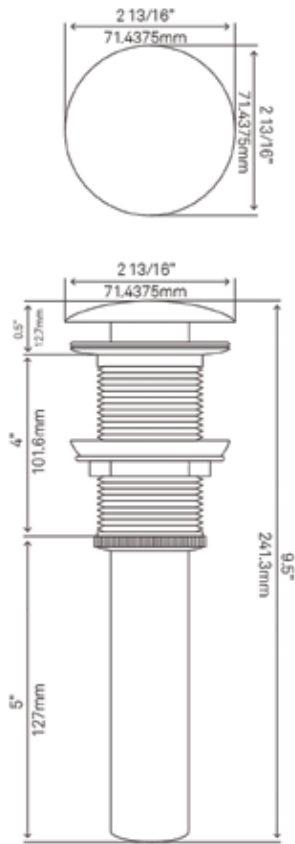

Pop-up Drains (w/o Overflow):
 UPD-BN • UPD-CH • UPD-ORB

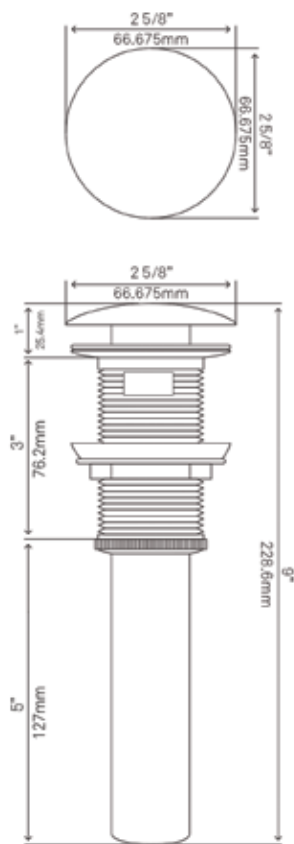

Pop-up Drains (w/o Overflow):
 PUD-BN-O • PUD-CH-O • PUD-ORB-O

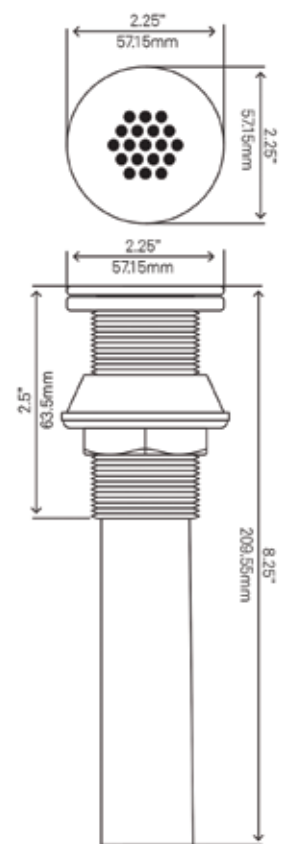

Strainer Drains:
 STD-BN • STD-CH • STD-ORB

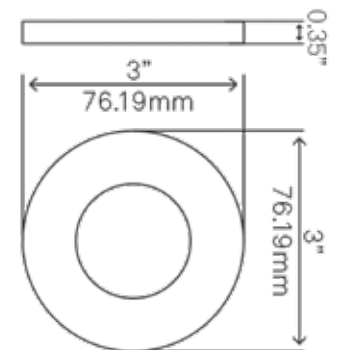

Mounting Rings:
 MR-001BN • MR-001CH • MR-001ORB

What drain do you recommend for my vessel sink?

We recommend using pop-up drains with our glass and porcelain sinks; umbrella drains with our stone; and strainer drains with our copper bath sinks. Some of our porcelain sinks need a drain with overflow.

What size hole is needed?

Our pop-up and umbrella drains ideally need a 1.625 inch counter hole. The grid-strainers need a 1.5 inch countertop hole.

Do these drains have a warranty?

Yes, they all have a Limited Lifetime Warranty.

Do I need a mounting ring?

They are only necessary for our glass vessel sinks. Our stone, copper and porcelain sinks do not need one.

May I use a drain or mounting ring from another vendor?

Yes, drains and mounting rings from other vendors will work with Novatto's drains and mounting rings. To ensure the finishes match, we recommend buying both items from the same vendor.

More questions? Feel free to contact our technical support team anytime. More info is also available on our website.

Novatto | P: 844.404.4242
 support@novattoinc.com
 NovattoInc.com

