

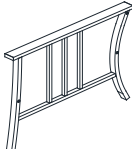

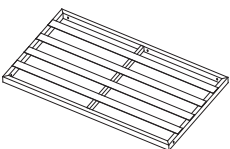

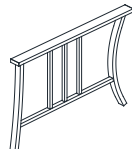
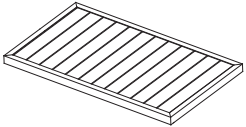
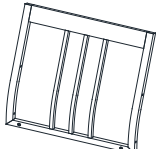

Sienna 4 PC Deep Seating Set

Before You Begin

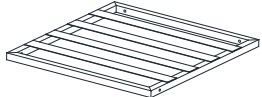
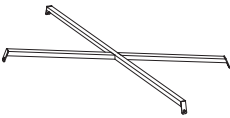
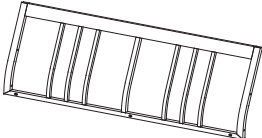
Please check to make sure you have the following (Quantity for complete set):

Ref	Part Name	Part Image	Qty	Ref	Part Name	Part Image	Qty
A	Right Arm		3	F	Loveseat Seat		1
B	Left Arm		3	G	Coffee Table Top		1
C	Lounge Chair Back		2	H	Coffee Table Leg		4
D	Lounge Chair Seat		2	I	Stretcher		1
E	Loveseat Back		1	J	Long Bolt (M6x45)		12

Parts List continues on the following page.



If you have any questions or concerns please call toll free at: 1-800-877-2290 / Fax: 1-800-733-4257, Monday through Friday, between 8:00 a.m. and 5:00 p.m., Central Standard Time.

K	Middle Bolt (M6x40)		13	O	Allen Wrench (M6)		1
L	Short Bolt (M6x15)		12	P	Back Cushion		4
M	Bolt Cover		37	Q	Seat Cushion		4
N	Washer(M6)		37				

Assembly Instructions

TO AVOID POTENTIAL SCRATCHING TO PARTS BY ROUGH GROUND SURFACE, COVER GROUND WITH SOFT SMOOTH PROTECTIVE MATERIAL ON WHICH TO PLACE PARTS DURING ASSEMBLY.

Step 1:

Remove protective wrapping and lay all parts on floor. Identify all parts packed in carton against attached parts list.

Step 2:

Lounge Chair: Assemble Right Arm (A), Left Arm (B), Lounge Chair Back (C), Lounge Chair Seat (D) together with Long Bolts (J), Medium Bolts (K), Washers (N), using Allen Wrench (O) to thread bolts into frame as shown in Diagram 1. Afterwards, put Bolt Covers (M) over Bolts and then put on Seat Cushion (Q) and Back Cushion (P) accordingly.

Diagram 1

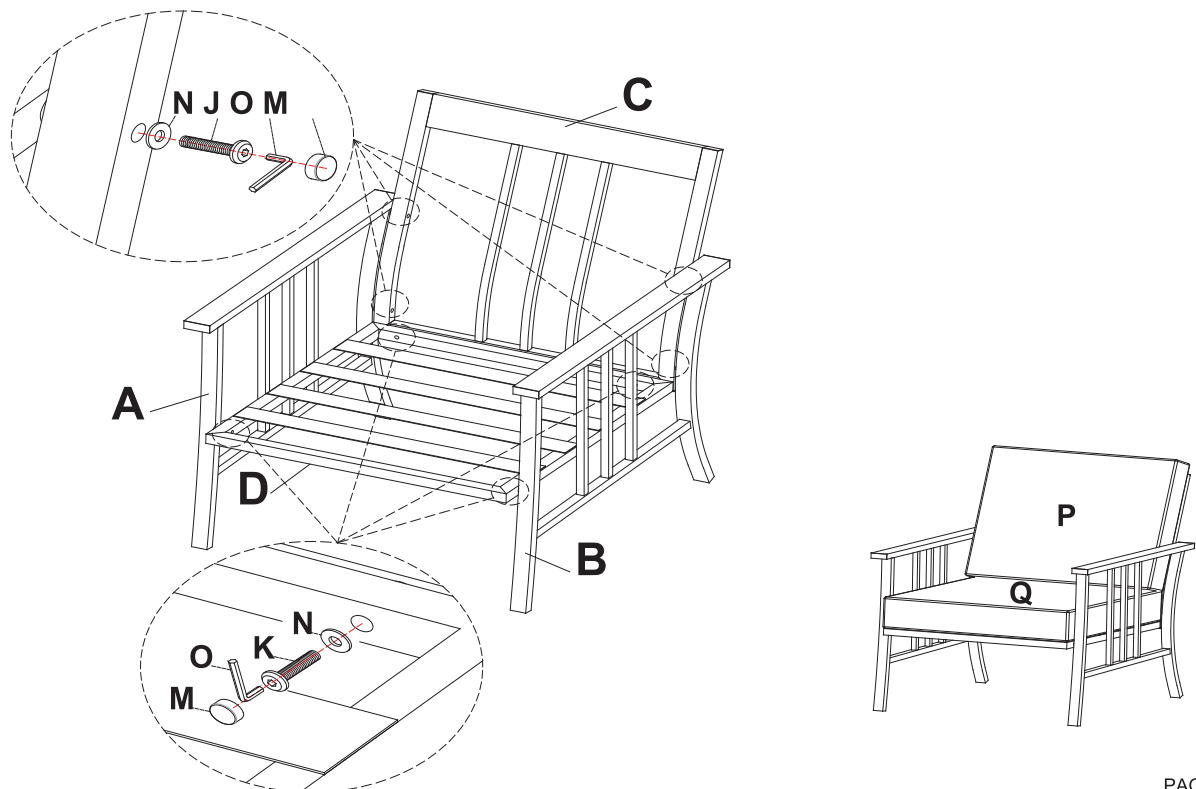

Step 3:

Love Seat: Assemble Right Arm (A), Left Arm (B), Loveseat Back (E), Loveseat Seat (F) together with Long Bolts (J), Medium Bolts (K), Washers (N), using Allen Wrench (O) to thread bolts into frame as shown in Diagram 2. Afterwards, put Bolt Covers (M) over Bolts and then put on Seat Cushions (Q) and Back Cushions (P) accordingly.

Step 4:

Coffee Table: Turn Table Top (G) upside down. Attach Leg (H), Stretcher (I) to Coffee Table Top (G) with Short Bolts (L) and Washers (N), using Allen Wrench (O) to thread bolts into frame as shown in Diagram 3. Then turn table to upright position.

Diagram 2

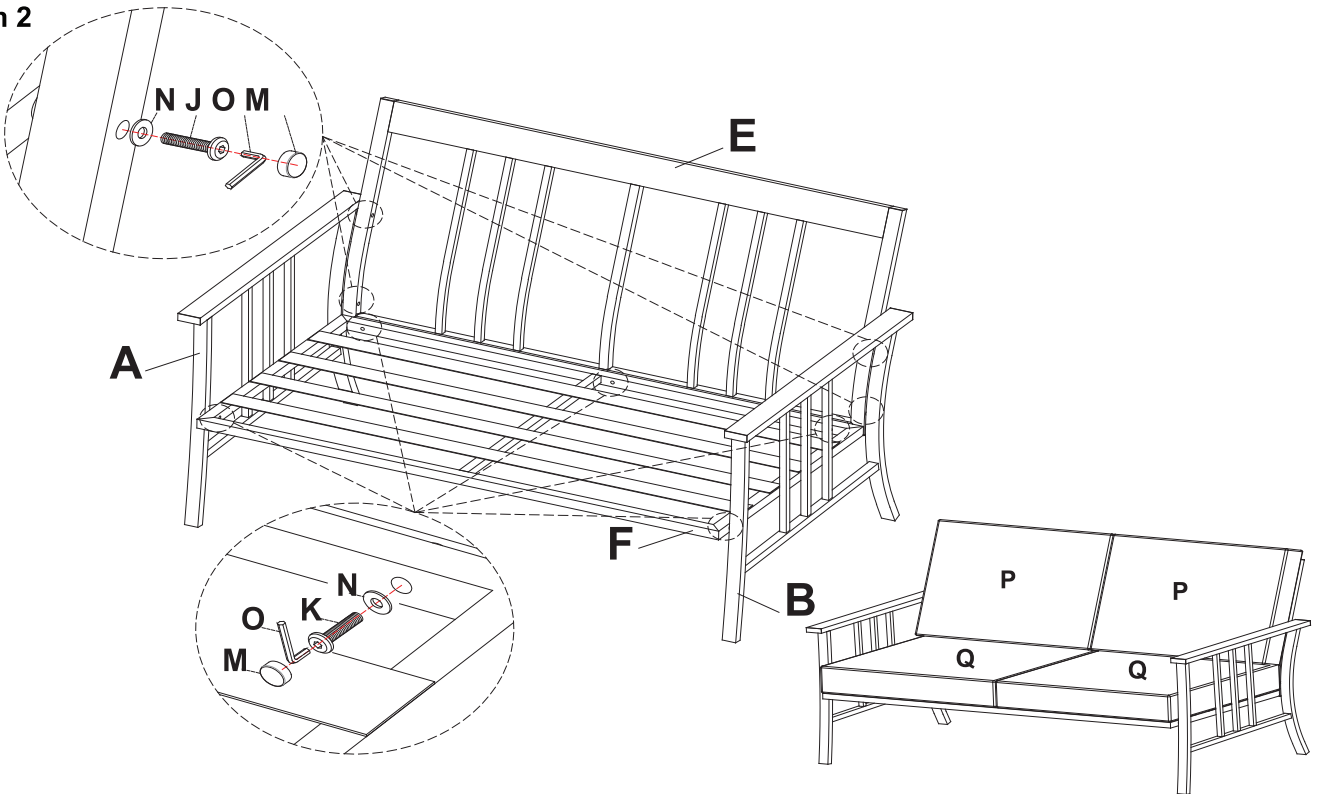
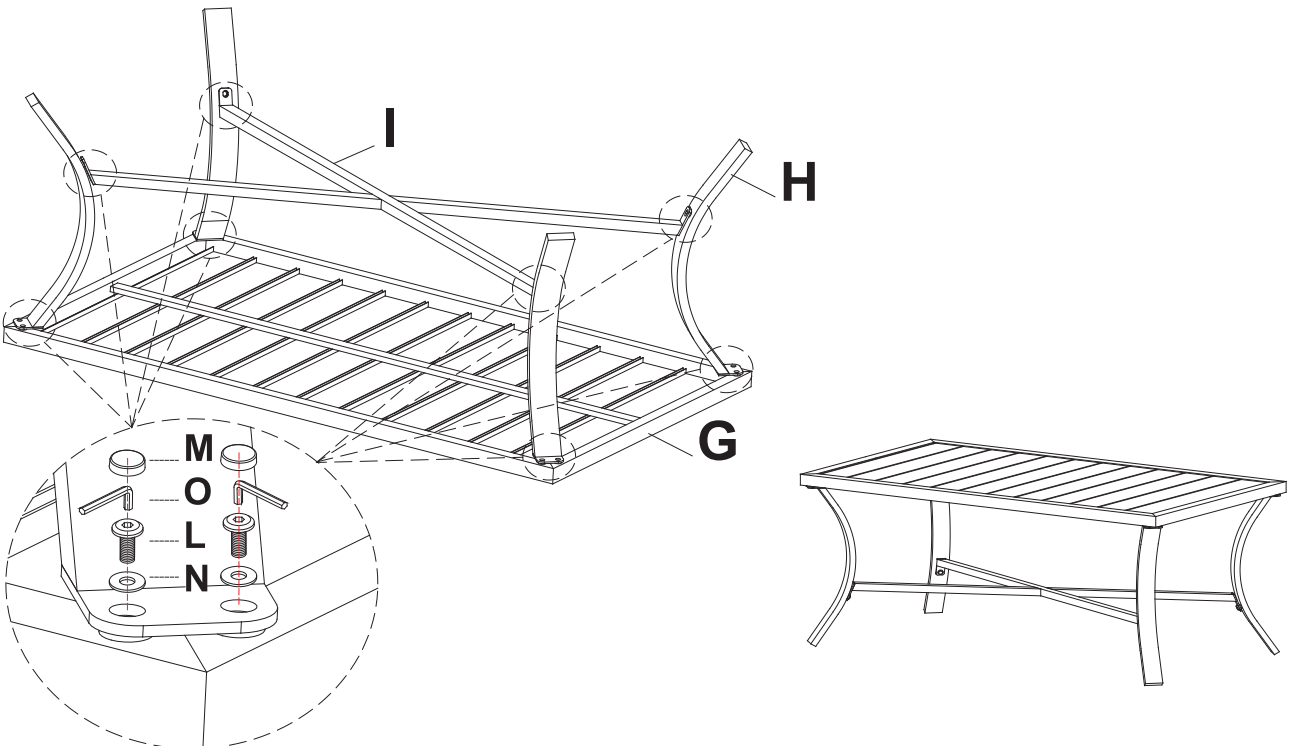

Diagram 3



HELPFUL TIP: When attaching frame parts together, first loosely thread all bolts into their attachment points and make sure all parts and bolts fit in place properly. Then go back to fully and securely tighten all bolts accordingly. Tightening first bolt immediately without all frame parts and bolts positioned in place may cause frame parts not to fit properly and make assembly difficult.

NOTE: IT IS USER'S RESPONSIBILITY TO MAKE SURE ALL PARTS ARE ASSEMBLED PROPERLY AND PARTS TIGHTENED SECURELY BEFORE USING FURNITURE.

Fully Assembled Set

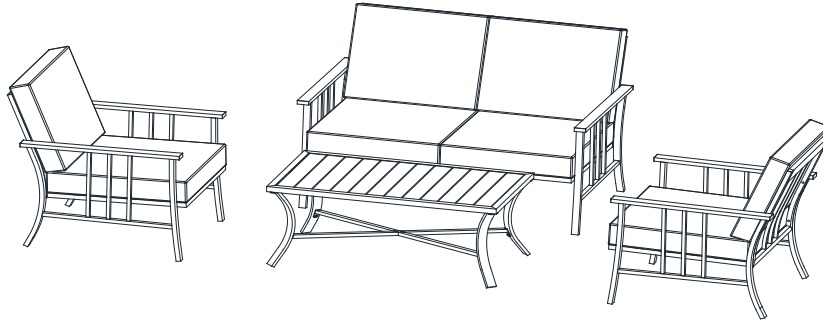

Care and Maintenance Instructions:

To maintain the beauty of your Living Accents furniture, wipe with a clean, damp cloth before each use. When not in use, protect your furniture with a Living Accents outdoor furniture cover. Visit your local retailer for a wide product selection.

Limited One Year Warranty

What is covered under this warranty?

This product is covered under the Manufacturers Limited Warranty. To ensure your complete satisfaction, this warrants to the original purchaser that this furniture is free from defects in material and workmanship as of the date of purchase and that it will, under normal use and proper care, remain so for one year after the date of purchase. Replacement of missing or initially defective parts will be sent at no charge for a period of 10 days from date of purchase. The manufacturer and retailer will not be responsible for missing parts and/or hardware after 10 days from date of purchase.

Warranty does not cover:

Freight and packaging charges to and from our customer service center remain the customer's responsibility. Labor or material charges to remove or replace parts are not covered under this warranty. Any floor sample sales or clearance sales from the store are not covered by this warranty. Furniture used for commercial purposes; failures caused by improper care; unreasonable or abusive use; damage by modification or alteration; freeze damage; acts of nature; rust; fabric stains; ripping or fading; purchased parts; or return freight and packaging charges are not covered under this warranty. Proof of purchase (dated register receipt) is required for warranty claims.

How to obtain service:

If you have any questions or concerns please call toll free at: 1-800-877-2290 / Fax: 1-800-733-4257, Monday through Friday, between 8:00 a.m. and 5:00 p.m., Central Standard Time.

Printed in China