

SFU4302VCX



Category	Compact 24"
Product family	Oven
Power supply	Electrical
Power supply	Electricity
Cooking method	Combi Steam
Cleaning system	VaporClean
EAN code	8017709252076



Aesthetic

Aesthetics	Classic	Silkscreen type	Symbols
Color	Stainless steel	Door	With 2 horizontal fascias
Finishing	Fingerprint-proof	Handle	Classic
Design	Flat	Handle color	Stainless steel
Material	Stainless steel	Logo	Embossed
Stainless steel type	Brushed	Control knobs	Classic
Glass type	Eclipse	Controls color	Stainless steel effect
Silkscreen color	Black		

Controls

Display technology	LCD	No. of controls	2
Controls setting	Control knobs		

Programs / Functions

No. of cooking functions	14
Automatic programmes	20

Traditional cooking functions

- | | | |
|-------------------|--------------|--------------------------|
| Static | Fan-assisted | True European convection |
| Turbo | Eco | Large grill |
| Fan grill (large) | Bottom | Convection bottom |

Cooking functions with steam

- | | | |
|---------------------------|--------------|------------|
| Steam | Fan-assisted | Circulaire |
| Warming and re-generation | | |

Other steam functions

- | | | |
|-------------------|--------------|-------------|
| Tank cleaning | Water outlet | Water input |
| Descaling program | | |

Other functions

- | | | |
|-----------------|-------------------|-------|
| Defrost by time | Defrost by weight | Proof |
| Sabbath | | |

Cleaning functions

- Vapor Clean

Options



- | | |
|-----------------------------|--|
| Time-setting options | Delayed start and automatic shut-off when cooking ends |
| Minute minder | Yes |
| Child safety lock | Yes |

- | | |
|----------------------|----------------------|
| Other options | Keep-warm, Eco light |
| Showroom mode | Yes |

Technical Features



- | | | | |
|----------------------------|---------|----------------------------------|-----------------|
| Minimum Temperature | 86 °F | Door | Cool-touch door |
| Maximum temperature | 482 °F | Removable door | Yes |
| No. of shelves | 3 | Full-glass inner door | Yes |
| No. of lights | 1 | Removable inner door | Yes |
| Lighting | Halogen | Total no. of door glasses | 3 |
| Replaceable light | Yes | Soft Close | Yes |

Light power	40 W	Cooling system	Tangential
Light on when door is open	Yes	Cooling duct	Single
Lower heating element power	1000 W	Temperature control	Electronic
Grill element - power	2000 W	Cavity material	EverClean enamel
Circular heating element - Power	1400 W	Water loading	Automatic Fill&Hide
Heating elements stop when door is opened	Yes	Tank capacity	40.5 oz
Boiler - Power	1000 W	Steam off when door is opened	Yes
Door opening	Standard opening		

Performance / Energy Label



Volume of the cavity 1.41 cu. ft.

Accessories Included



Rack with back stop	1	Stainless steel mesh tray (1.6" deep)	1
Enameled 1.6"-deep tray	1	Telescopic Guide rails, total Extraction	1
Insert grid	1	Other	Sponge/ Boiler cover/ Carafe
Stainless steel tray (0.8" deep)	1		

Electrical Connection

Voltage	230 V	Current	13 A
Nominal power	3400 W	Frequency	60 Hz
Voltage	120/208 V	Power cord length	45 1/4 "

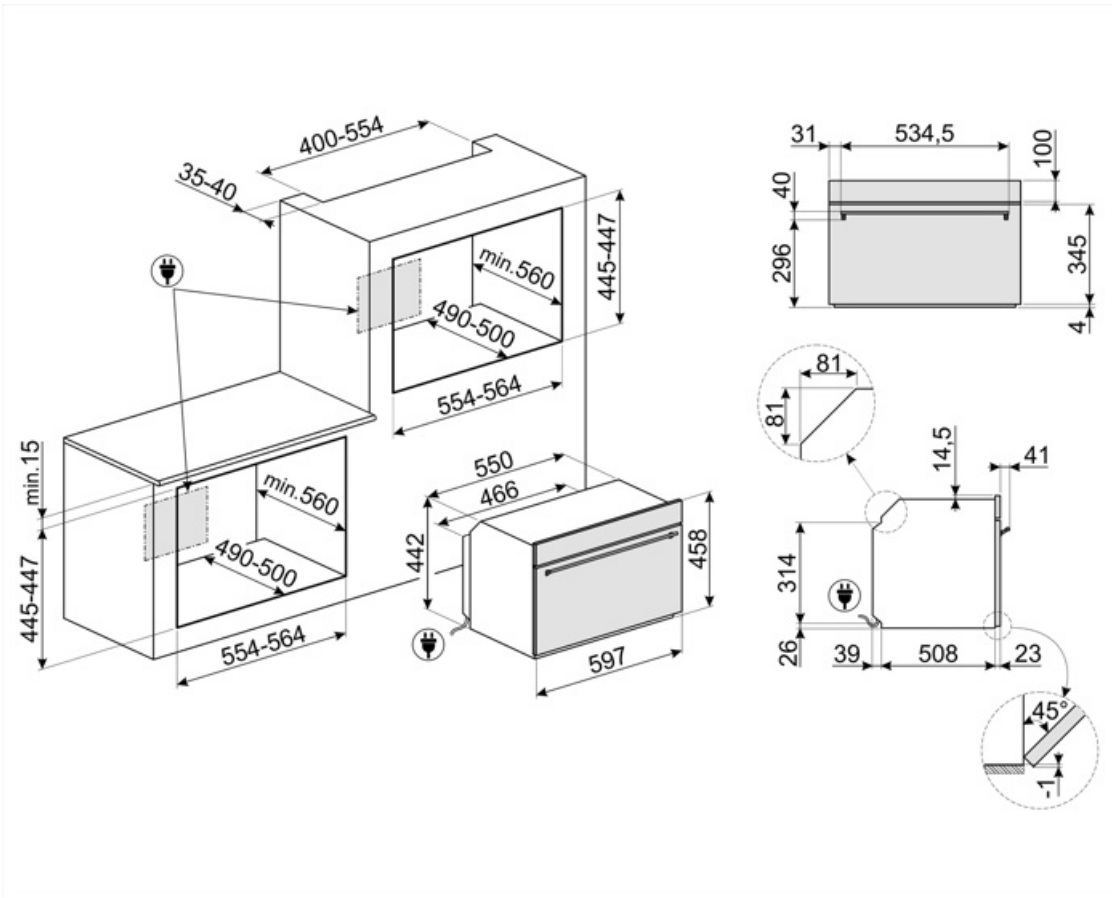

Compatible Accessories

BN620-1

Enamelled tray, 20mm deep



GTP

****Partial-extension telescopic guides****
Length: 14" Extraction: 11 1/4" Material:
Stainless steel AISI 430 polished



KIT370X

27" Trim kit for Classic compact ovens

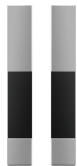

PR3845X

Antifingerprint stainless steel. Cover for
furniture in column installation of more
ovens



BN640

Enamelled tray, 40mm deep



KIT330X

30" Trim kit for Classic compact ovens











































PALPZ

Pizza shovel with fold away handle
width: 315mm length : 325mm



Symbols glossary

 <p>Child lock: some models are fitted with a device to lock the programme/cycle so it cannot be accidentally changed.</p>	
 <p>Combination steam: ovens can be used either as a steam oven, or as a traditional oven, or alternatively the two methods can be combined.</p>	 <p>Air cooling system: to ensure a safe surface temperatures.</p>
 <p>Defrost by time: with this function the time of thawing of foods are determined automatically.</p>	 <p>Defrost by weight: With this function the defrosting time is determined</p>
 <p>Descaling function: Is essential to remove excess deposits of limestone in the tank and allow the proper operation of the product. The need to perform this operation is signaled by the product itself.</p>	 <p>Triple glazed doors: Number of glazed doors.</p>
 <p>Automatic lighting switches off: for greater energy savings, the lighting switches off automatically after one minute from the start of cooking.</p>	 <p>Electric</p>
 <p>Enamel interior: The enamel interior of all Smeg ovens have a special antacid lining which helps keep the interior clean by reducing the amount of cooking grease adhering to it.</p>	 <p>Fingerprint proof stainless steel: Fingerprint proof stainless steel keeps stainless steel looking as good as new.</p>
 <p>A FULL STEAM oven has 3 steam COMBINATION cooking functions available, and it is also possible to use it to cook with PURE steam only. The steam is adjustable between 30% and 70% and there is the option of 100% pure steam if required. The water is loaded into the oven before cooking via an automatic loading tube. The oven calculates the exact amount of water required for the desired cooking function, up to 1.2lt. Water is introduced into the cavity, and becomes steam during cooking. Continuous steam is generated based on the setting at the start of cooking.</p>	 <p>Circogas: In gas ovens the fan distributes the heat quickly and evenly throughout the oven cavity, avoiding flavour transfer when cooking a number of different dishes at the same time. In electric ovens this combination completes cooking more quickly of foods that are ready on the surface, but that require more cooking inside, without further browning.</p>
 <p>Fan with upper and lower elements: The elements combined with the fan aim to provide more uniform heat, a similar method to conventional cooking, so pre-heat is required. Most suitable for items requiring slow cooking methods.</p>	 <p>Upper and lower element only: a traditional cooking method best suited for single items located in the centre of the oven. the top pf the oven will always be hottest. Ideal for roast, fruit cakes, bread etc.</p>
 <p>Lower heating element only: This function is ideal for foods that require extra base temperature without browning, e.g. pastry dishes, pizza. Also suitable for slow cooking of stews and casseroles.</p>	 <p>True European Convection: The combination of the fan and circular heating element around it provides many benefits, including no preheat if cooking time is longer than 20 minutes, no flavor transfer when cooking different foods at the same time, lower energy consumption, and shorter cooking times. Suitable for all types of food preparations.</p>

 <p>ECO: The combination of the grill, fan and lower element is particularly suitable for cooking small quantities of food.</p>	 <p>Grill element: Using of grill gives excellent results when cooking meat of medium and small portions, especially when combined with a rotisserie (where possible). Also ideal for cooking sausages and bacon.</p>
 <p>Fan with grill element: The fan reduces the fierce heat from the grill, providing an excellent method of grilling various foods, chops, steaks, sausages etc. giving even browning and heat distribution, without drying out the food. The top two levels recommended for use, and the lower part of the oven can be used to keep items warm at the same time, an excellent facility when cooking a grilled breakfast. Half grill (centre portion only) is ideal for small quantities of food.</p>	 <p>Steam cooking: it's a natural way of cooking for any kind of products, from vegetables to desserts, to preserve the nutritional and organoleptic properties of ingredients. Ideal for cooking without fat, to heat up food without drying. Steam is ideal for simultaneous cooking of meals that require different cooking times.</p>
 <p>Fan combined with traditional cooking, where heat is generated from above and below, provides uniform heat. Adding the steam function allows the same cooking results in less time.</p>	 <p>Circulaire element with steam: Cooking with the simultaneous use of the circular heating element in combination with fan and steam supply.</p>
 <p>FUN_STEAM_OTHER_WATER_IN_OUT_72dpi</p>	 <p>Reheat: This function can reheat precooked dishes, without becoming dry or hard.</p>
 <p>Circulaire with upper and lower elements: The use of the fan with both elements allows food to be cooked quickly and effectively, ideal for large joints that require thorough cooking. It offers a similar result to rotisserie, moving the heat around the food, instead of moving the food itself, enabling any size or shape to be cooked.</p>	 <p>Compact appliances with a height of 45 cm - perfect solution to meet the functional requirements of kitchen sets of small height. Available in several types and in different styles.</p>
 <p>All glass inner door: All glass inner door, a single flat surface which is simple to keep clean.</p>	 <p>The inner door glass: can be removed with a few quick movements for cleaning.</p>
 <p>KEEP_WARM_72dpi</p>	 <p>Side lights: Two opposing side lights increase visibility inside the oven.</p>
 <p>ECO-logic: option allows you to restrict the power limit of the appliance real energy saving.</p>	 <p>Air at 40°C provides the perfect environment for proving yeast type dough mixes. Simply select the function and place dough in the cavity for allotted</p>
 <p>Sabbath: This function allows you to cook food during the Sabbath, the Holiday of rest in the Jewish religion, respecting the precepts. The oven works</p>	 <p>The oven cavity has 3 different cooking levels.</p>
 <p>Soft close: all models are equipped with advanced function of smooth closing of the door, which allows the device to close smoothly and quietly.</p>	 <p>To guarantee the optimal functioning of the appliance, it is suggested to carry out the tank cleaning roughly once every 2-3 months.</p>
 <p>Telescopic rails: allow you to pull out the dish and check it without having to remove it from the oven entirely.</p>	 <p>Electronic control: Allows you to maintain temperature inside the oven with the precision 2-3 ° C. This enables to cook meals that are very sensitive to temperature changes, such as cakes, souffles, puddings.</p>



Vapor Clean: a simple cleaning function using steam to loosen deposits in the oven cavity.



The capacity indicates the amount of usable space in the oven cavity in litres.



The capacity indicates the amount of usable space in the oven cavity in litres.