

ASSEMBLY INSTRUCTIONS

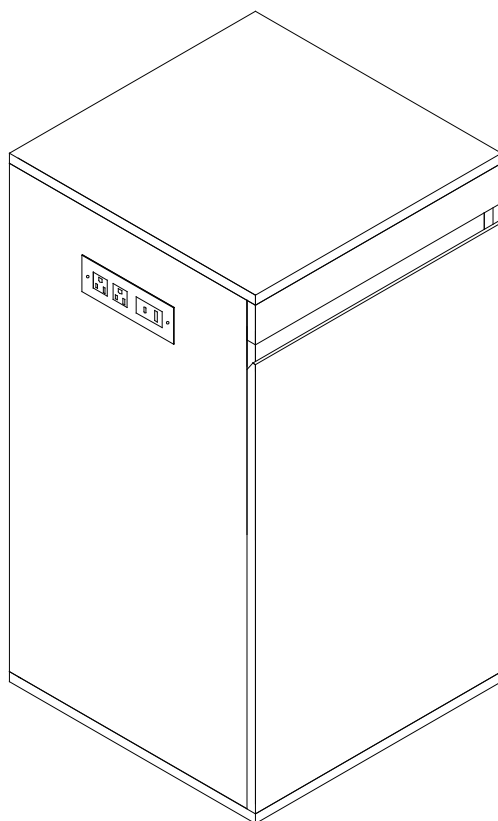

**NOTE: 50% TIGHTEN BEFORE
FIXING ALL BOLTS**

N704P444759

Thank you for choosing our products.

1. Return Policy







DO NOT RETURN TO THE STORE! Skip the process of returning your product and contact us directly for a replacement

If you find that parts of your order are missing or damaged, we will gladly ship any needed replacement parts free of charge.

If you have found any sort of defect, please contact our customer service department and let us know the details of your order and any issues encountered, we will try our best to provide you with a solution.































Recommendations Before Beginning Assembly

-  • Read instructions, cover to cover
-  • Have 2-4 adults on hand for assembly depending on product size
-  • Do not assemble directly on flooring or carpet
-  • Assemble on a clean non-marring surface (example: packing foam)
-  • Save all packaging until finished

3. Assembly Notice:

- If you encounter any problems during assembly and find that you cannot continue, rest assured we will help you solve the situation as soon as possible. Simply keep all of the parts of the product stored in a safe place and contact us immediately so we may assist you further.
- Once you have opened your package, remove all inner hardware packages and take the parts out. One by one, Place the parts out neatly in front of you, then refer to the instructions to ensure no parts are missing. If any pieces are found missing, please carefully look in the box first, as the hardware packaging might have torn making the hardware spill in the box.
- Some key parts of your product may be stored and hidden inside of other parts. Please open any zippered or hook & loop storage compartments to remove all parts. (example: cushions and legs being stored in the underside of a sofa)
 - **IMPORTANT:** When setting up your product, **DO NOT INSTALL THE SCREWS ALL THE WAY IN THE BEGINNING.** Place each screw into their proper hole and use your hand to twist the screw halfway. Twist all the screws in halfway to ensure the holes will match up properly and the product is level on the ground. When everything seems fitted, then tighten the screws.
 - When you have completed assembly, we suggest you have more than one person to assist you with lifting and placing the product.

Care & Maintenance



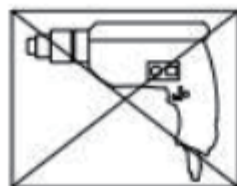

- 

 Do not put hot items directly on furniture surface
- 

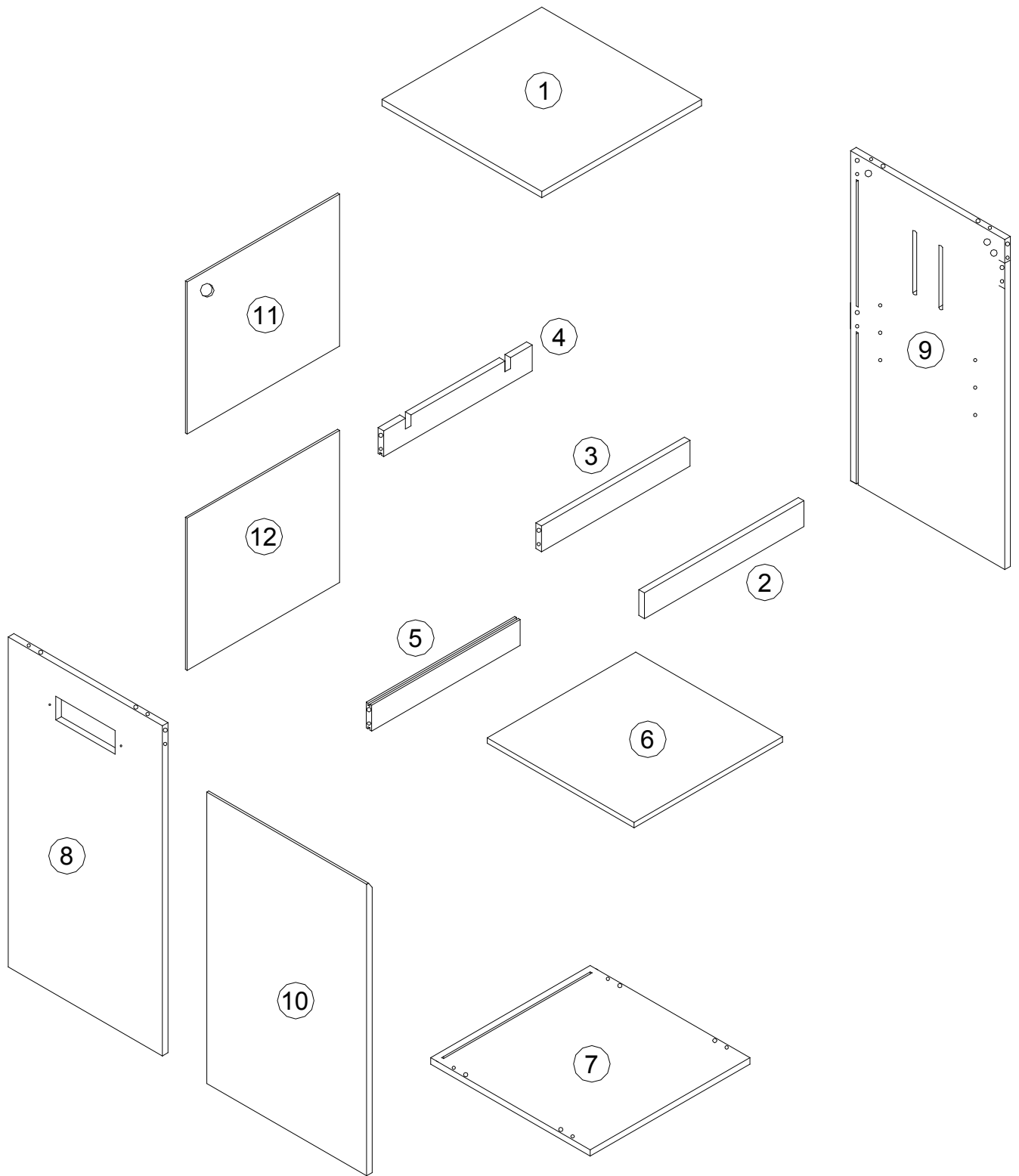
 Do not clean furniture with harsh cleansers or polish
- 

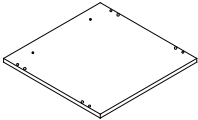
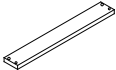
 Do not place furniture under direct sunlight
- 

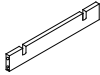
 Do not place furniture near heating or cooling vents
- 

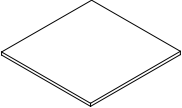
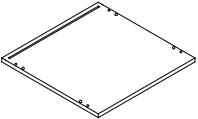
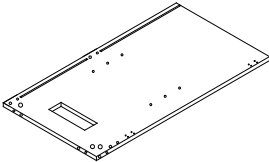
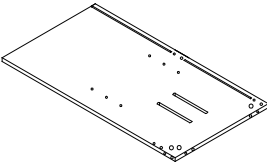
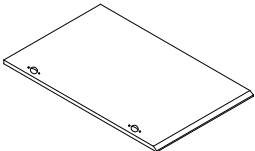
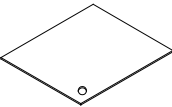
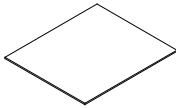
 Do not write on furniture without a padded barrier to protect the surface
- 

 Do not place furniture outside. For indoor use only
- 

 Not for commercial use. For residential use only
- 

 Stains may be removed with mild soap solution and damp cloth
- 

 Children should not climb or jump on the furniture
- 

 Dust and pick-up spills using a clean, non-colored, lint-free cloth







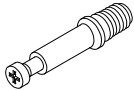

Caution

- This product contains small components. Please ensure that they are kept away from small children.
- Do not use power tools to assemble your furniture. Power tools may strip or damage the parts.

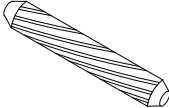

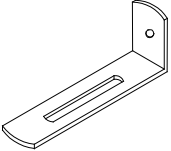
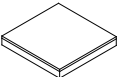
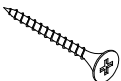
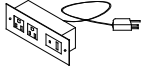
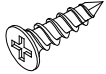
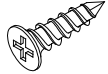

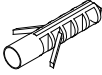
				
① x1PC	② x1PC	③ x1PC	④ x1PC	⑤ x1PC
				
⑥ x1PC	⑦ x1PC	⑧ x1PC	⑨ x1PC	⑩ x1PC
				
⑪ x1PC	⑫ x1PC			

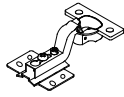
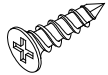
				
6*35mm	15*10mm	8*30mm	4*12mm	
Ax12PCS	Bx12PCS	Cx16PCS	Dx2PCS	Ex2PCS
				
Fx4PCS	4*40mm	Hx1PC	3*12mm	3*14mm
	Gx6PCS		Ix2PCS	Jx8PCS
				
Kx8PCS	Lx2PCS	Mx4PCS	Nx2PCS	3.5*14mm
				Ox12PCS

STEP 1

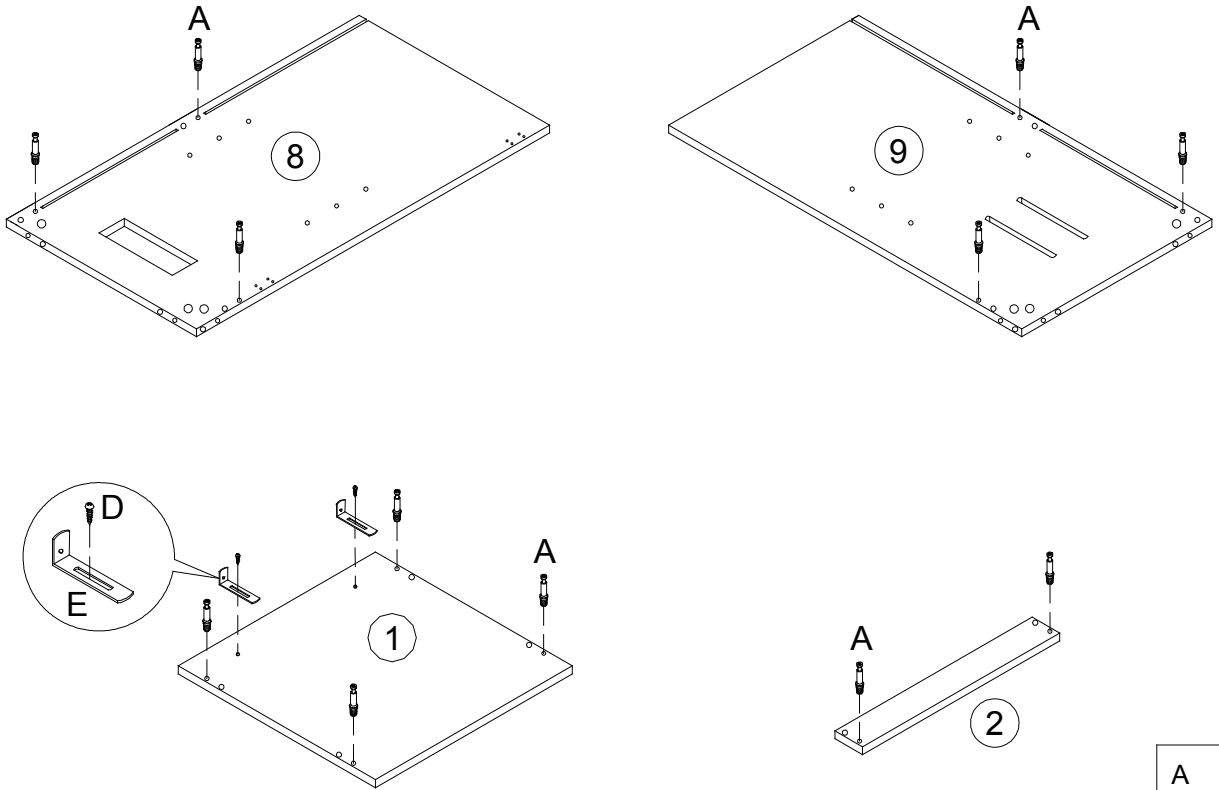

A		12 pcs
D		2 pcs
E		2 pcs

STEP 2

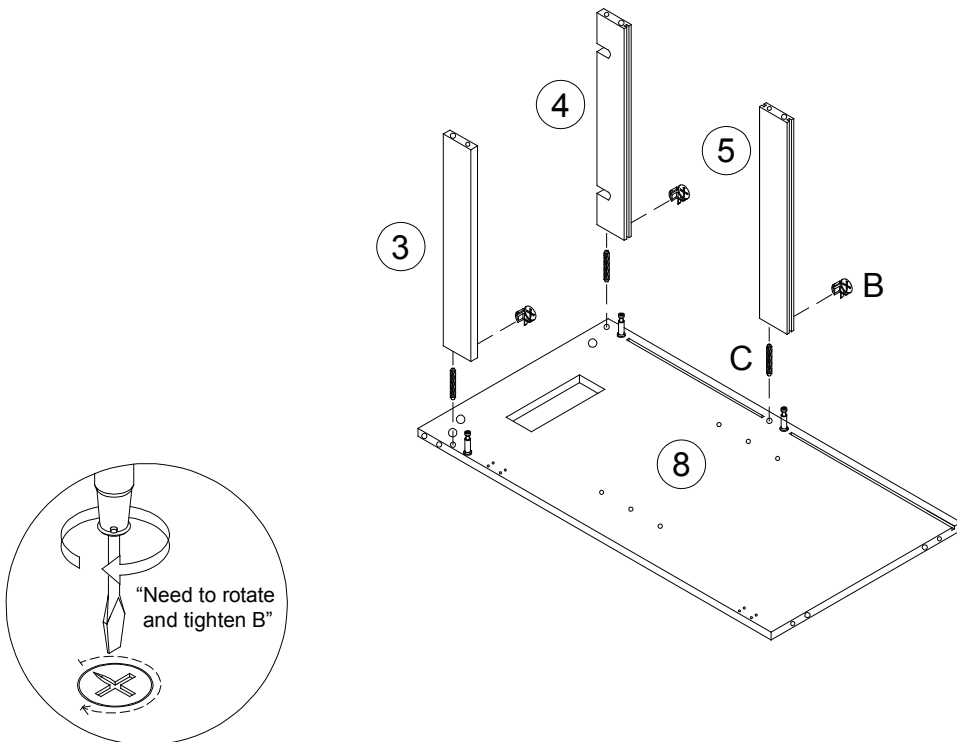

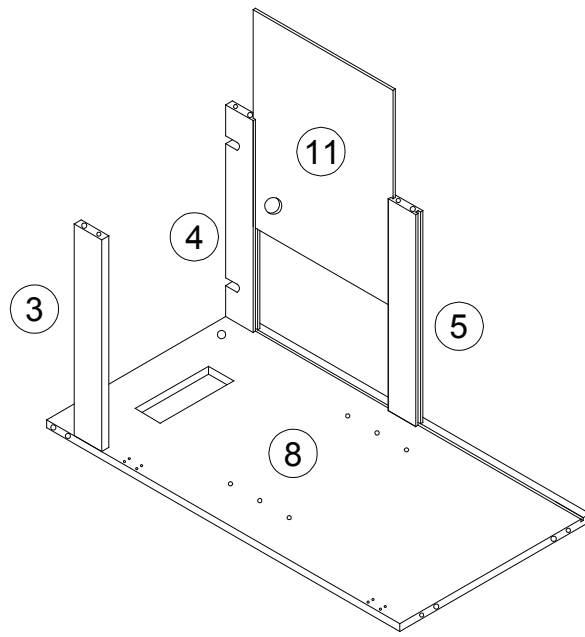

B		3 pcs
C		3 pcs

STEP 3

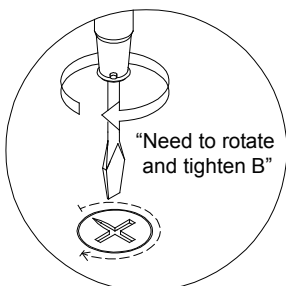
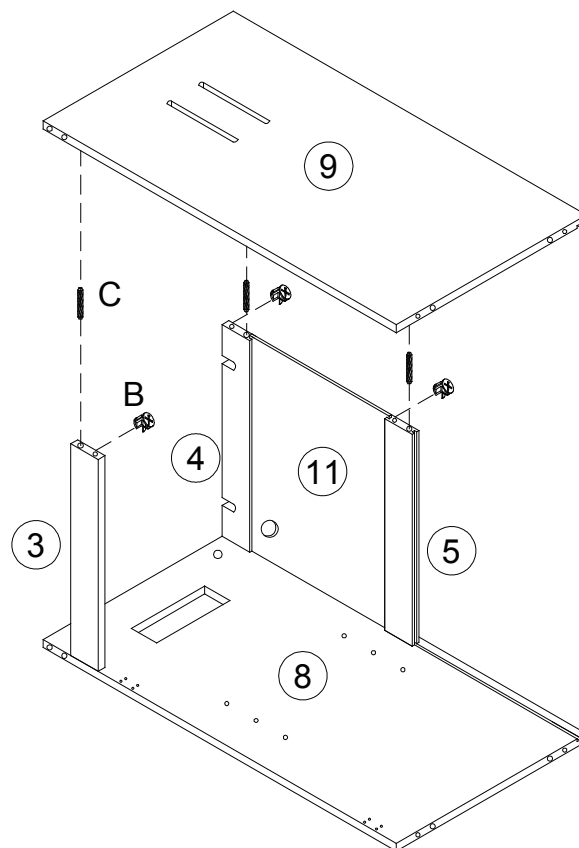

STEP 4



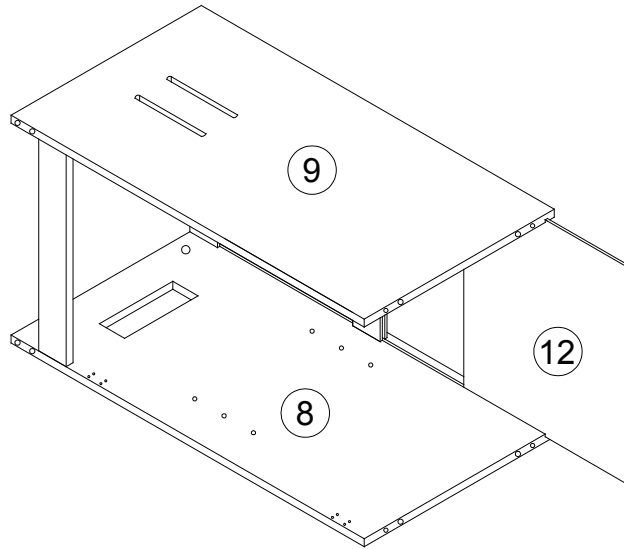

B		3 pcs
C		3 pcs

STEP 5



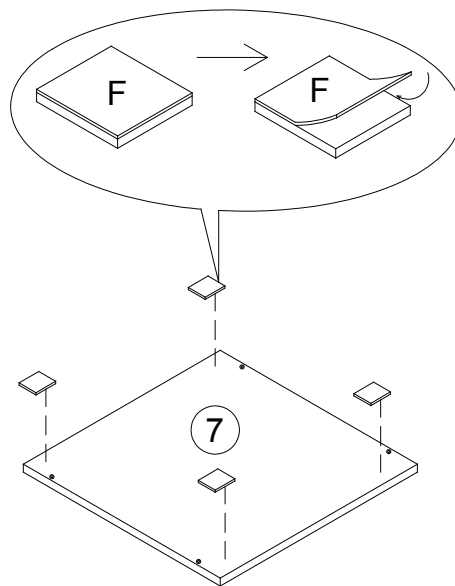

STEP 6



F  4 pcs

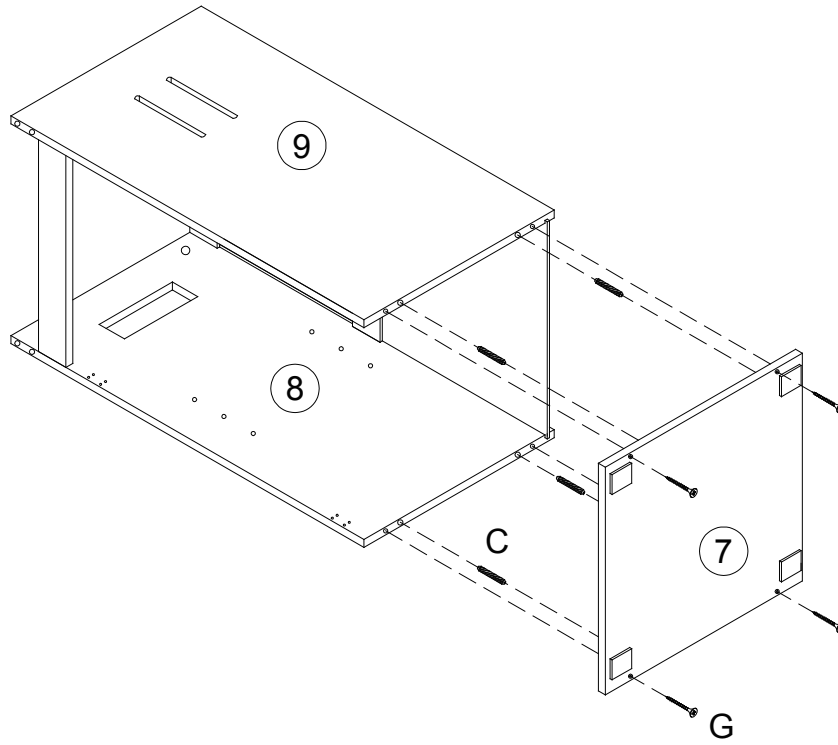

STEP 7



C		4 pcs
G		4 pcs

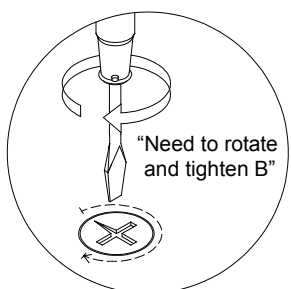
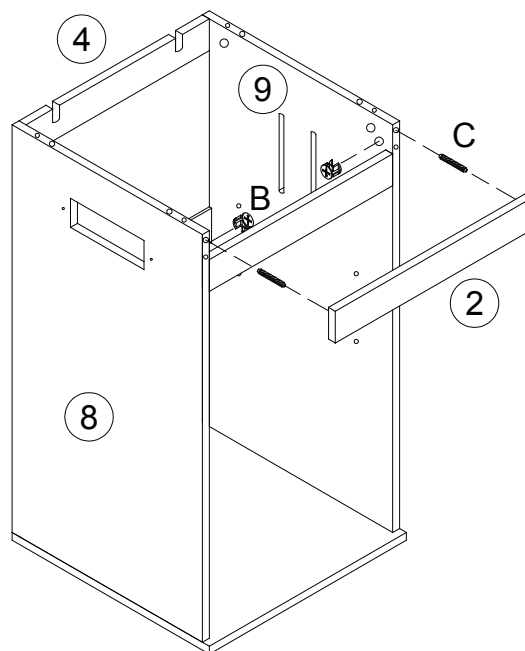

STEP 8



B		2 pcs
C		2 pcs

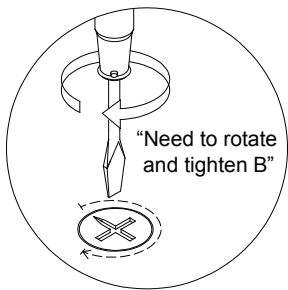
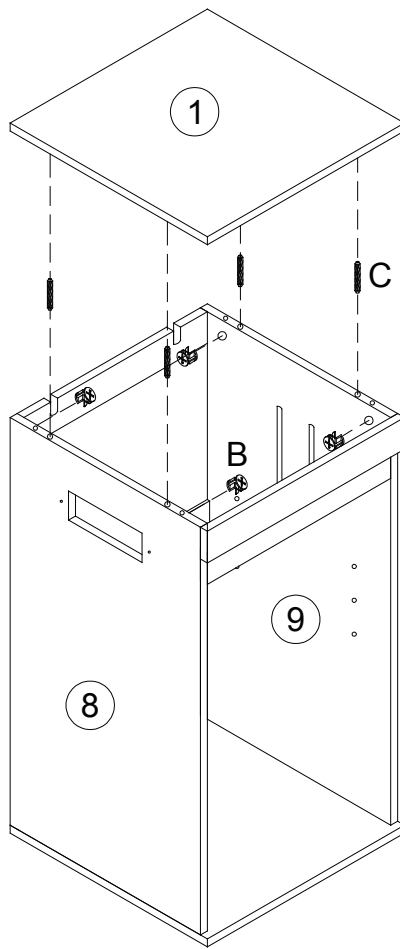

STEP 9



B		4 pcs
C		4 pcs

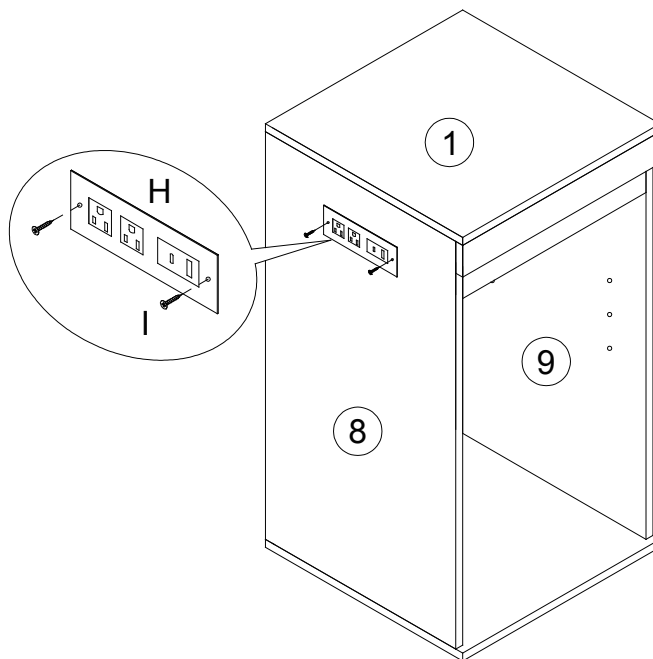

STEP 10



H		1 pc
I		2 pcs

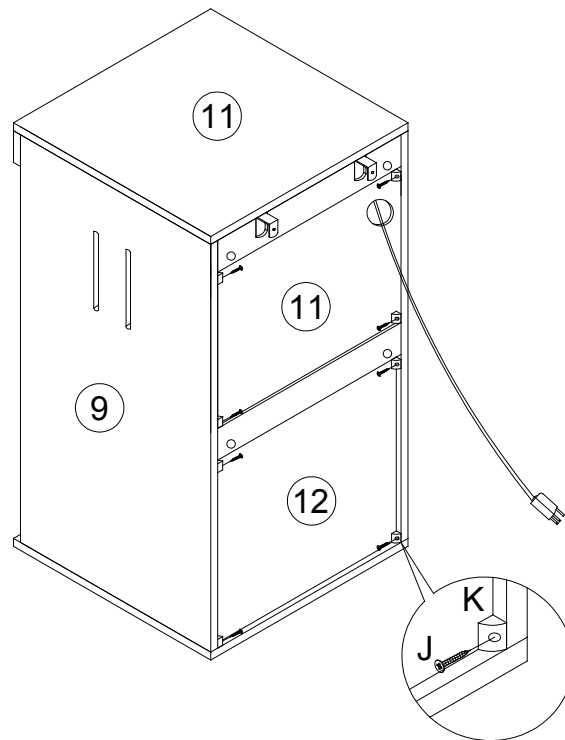

STEP 11

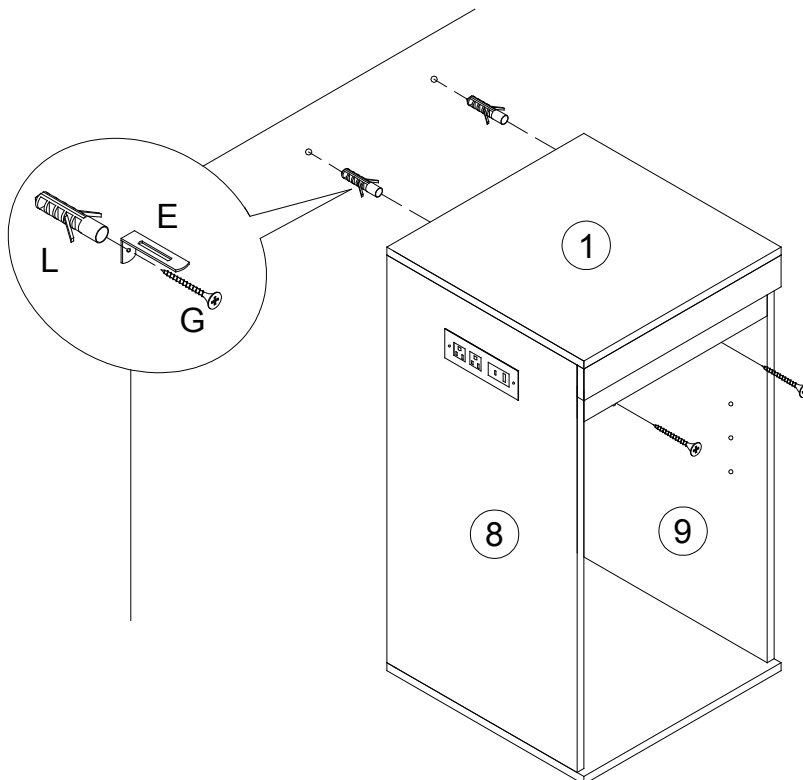

J		8 pcs
K		8 pcs

STEP 12



G		2 pcs
L		2 pcs

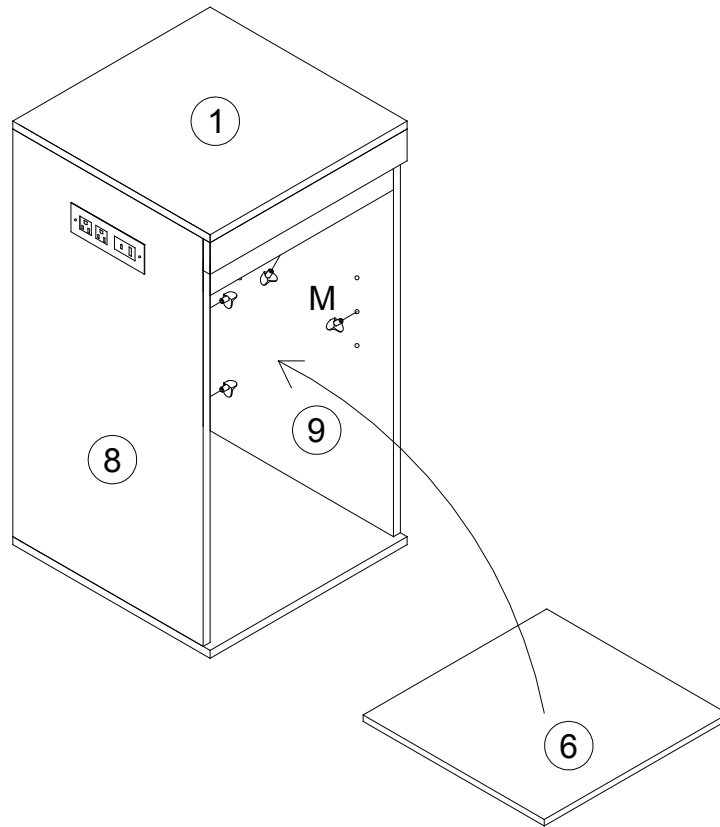

STEP 13

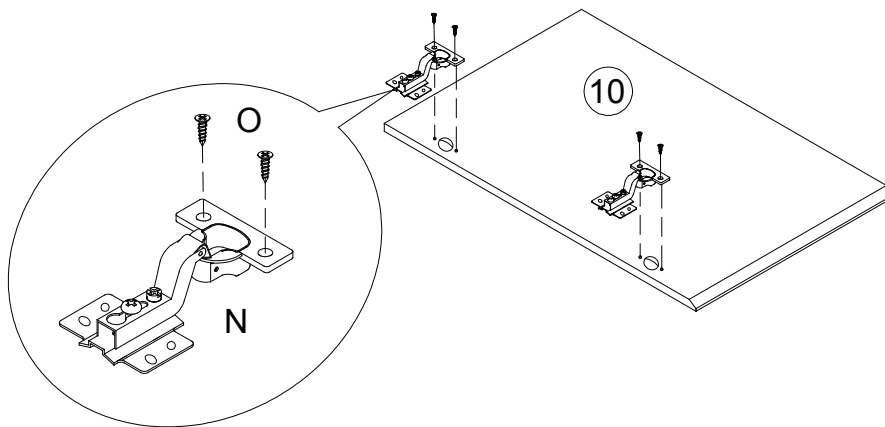

M  4 pcs

STEP 14



N  2 pcs
O  4 pcs

STEP 15

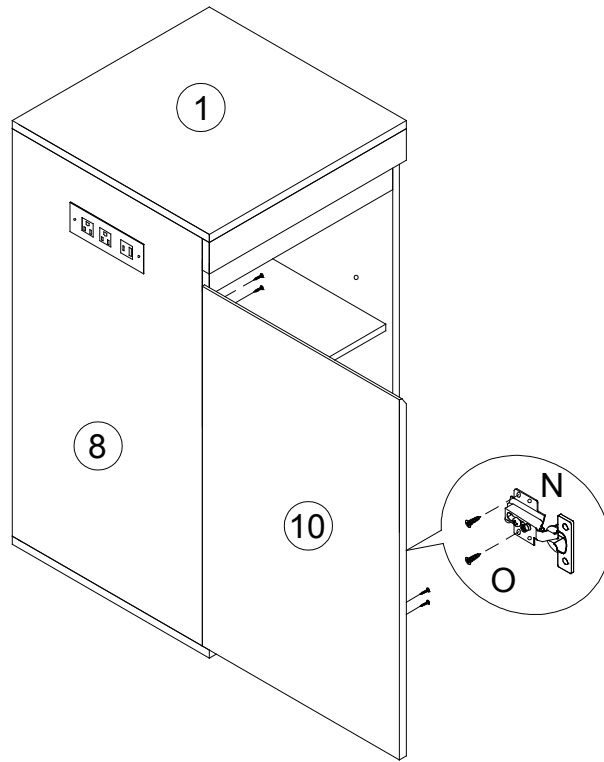

O  4 pcs

STEP 16

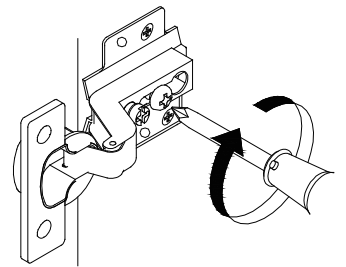
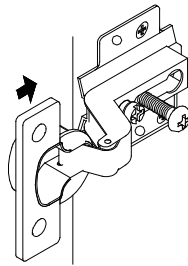
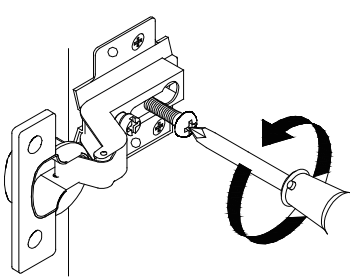
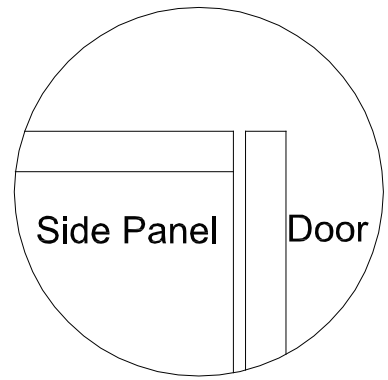
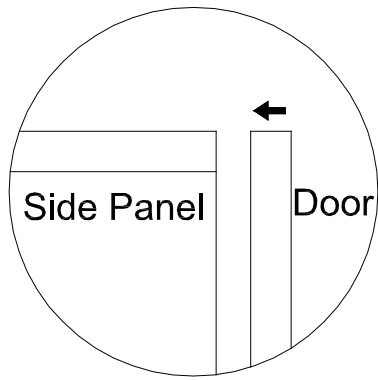

If there is gap between the side panel and the door, loosen the screw at the back of the hinge as shown, then move the hinge in or out until the desired gap is achieved, and then re-tighten the back screw.

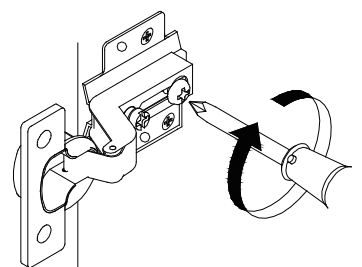
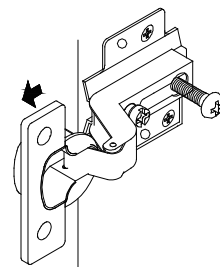
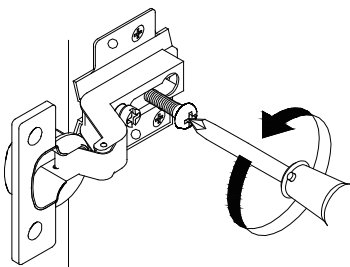
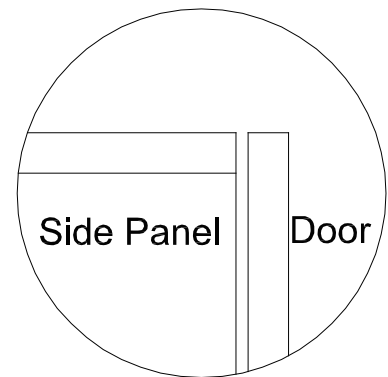
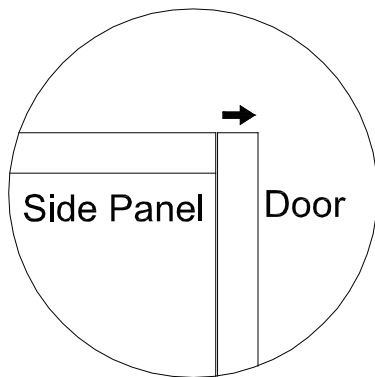

If there is gap between the side panel and the door, loosen the screw at the back of the hinge as shown, then move the hinge in or out until the desired gap is achieved, and then re-tighten the back screw as shown.

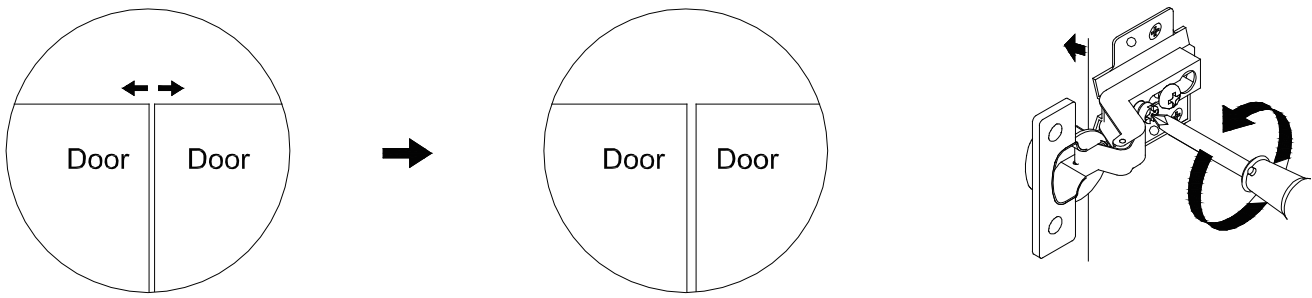

If the gap is too tight between the two doors, loosen the screw at the front of the hinge as shown to make the adjustment and then re-tighten the screw.

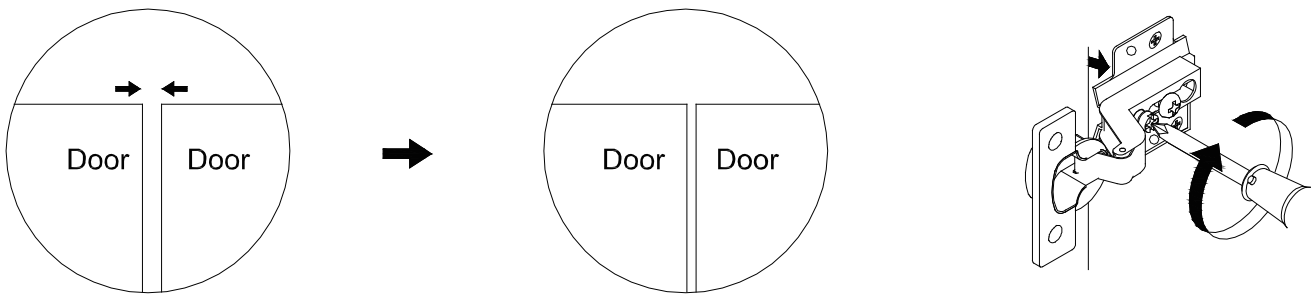

If the gap is too tight between the two doors, loosen the screw at the front of the hinge as shown to make the adjustment and then re-tighten the screw.

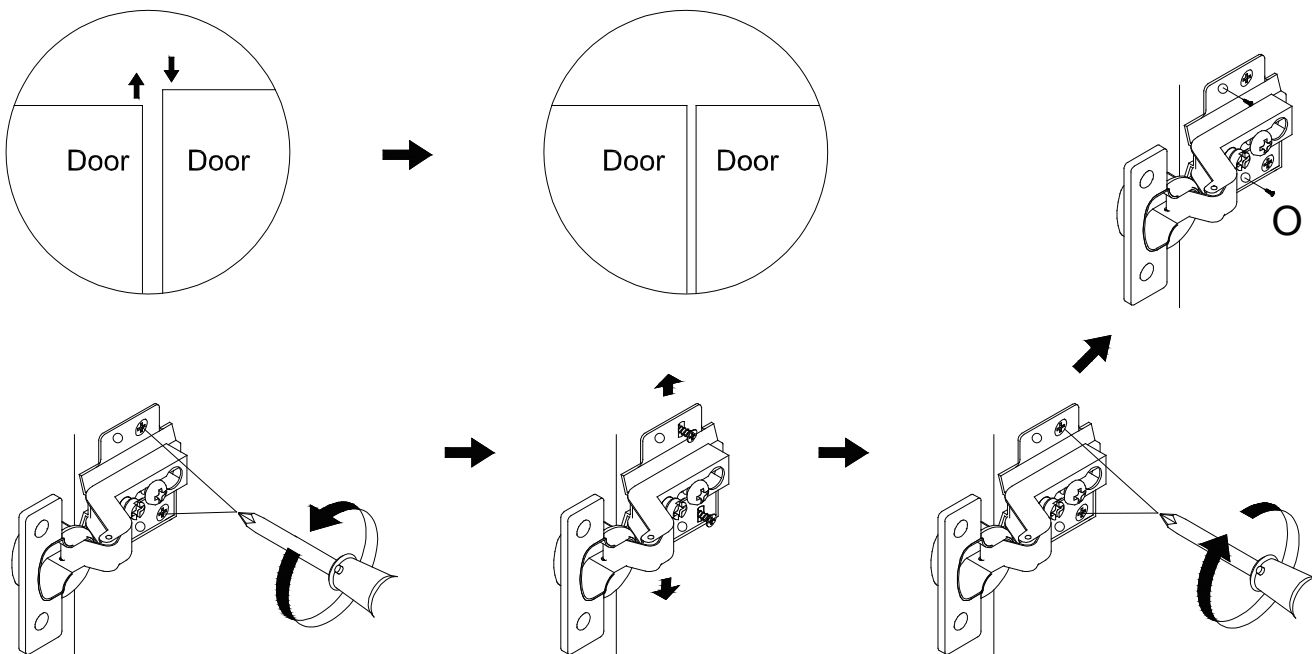

- If the doors are not leveled with each other, loosen the screws (installed on STEP 15) at the Panel Wing of the hinge, then adjust the hinge up or down until the desired level or when both doors are leveled, and then re-tighten the screws.
- When all the desired positions are in place, use the remaining twelve Screw (O) to fasten the Wing Panel using the front two screw holes on Panel Wing.

The assembly of the Cabinet is complete.

O  4 pcs

Attestation of Conformity



Reference No. : LCSA03045015E

Applicant : Dongguan Jingdeli Intelligent Technology Co.,Ltd.

Address : Room 202, Building 3, No.28, Dongkeng Town Yanhe West 1st Road, Dongkeng Town, Dongguan, 523000, Guangdong, China

Trade Mark : N/A

Product : Furniture Power Distribution Units

Model : JDL52TSKU, JDL maybe followed up to eight characters

Standard : FCC 47 CFR Part 15 Subpart B, Class B(SDoC), ANSI C63.4 -2014

Important note:

Is herewith confirmed to comply with the requirements set out in the FCC Rules and Regulations FCC 47 CFR Part 15 Subpart B and CISPR PUB. 22 and the measurement procedures were according to ANSI C63.4-2014. The said equipment in the configuration described in this report shows the maximum emission levels emanating from equipment are within the compliance requirements.

This device is in conformance with Part 15 of the FCC Rules and Regulations for radio frequency devices. Operation of this product is subject to the following two conditions: (1) this device may not cause harmful interference, and (2) this device must accept any interference received, including interference that may cause undesired operation.



Date of issue: March 11, 2025



Shenzhen LCS Compliance Testing Laboratory Ltd.
Room 101, 201, Building A and Room 301, Building C, Juji Industrial Park, Yabianxueziwei, Shajing Street,
Bao'an District, Shenzhen, Guangdong, China
Tel: (86)755-82591330 Fax: (86)755-82591332
Http://www.lcs-cert.com Email: webmaster@lcs-cert.com

1 / 1



Production Name: Furniture Power Distribution Unit
Model: JDL22PH

"This device complies with Part 15 of the FCC Rules.
Operation is subject to the following two conditions: (1) this device may not cause harmful interference, and (2) this device must accept any interference received, including interference that may cause undesired operation."

This authorizes the application of the Certification Mark(s) shown below to the models described in the Product(s) Covered section when made in accordance with the conditions set forth in the Certification Agreement and Listing Report. This authorization also applies to multiple listee model(s) identified on the correlation page of the Listing Report.

This document is the property of Intertek Testing Services and is not transferable. The certification mark(s) may be applied only at the location of the Party Authorized To Apply Mark.

Applicant:	Dongguan Jingdeli Intelligent Technology Co.,Ltd.	Manufacturer:	Dongguan Jingdeli Intelligent Technology Co.,Ltd.
Address:	Room 202, Building 3, No.28, Dongkeng Town Yanhe West 1st Road, Dongkeng Town, Dongguan, Guangdong 523000	Address:	Room 202, Building 3, No.28, Dongkeng Town Yanhe West 1st Road, Dongkeng Town, Dongguan, Guangdong 523000
Country:	China	Country:	China
Party Authorized To Apply Mark:	Same as Manufacturer		
Report Issuing Office:	Intertek Testing Services (Shanghai FTZ) Co., Ltd		
Control Number:	<u>5032500</u>	Authorized by:	 for L. Matthew Snyder, Certification Manager



This document supersedes all previous Authorizations to Mark for the noted Report Number.

This Authorization to Mark is for the exclusive use of Intertek's Client and is provided pursuant to the Certification agreement between Intertek and its Client. Intertek's responsibility and liability are limited to the terms and conditions of the agreement. Intertek assumes no liability to any party, other than to the Client in accordance with the agreement, for any loss, expense or damage occasioned by the use of this Authorization to Mark. Only the Client is authorized to permit copying or distribution of this Authorization to Mark and then only in its entirety. Use of Intertek's Certification mark is restricted to the conditions laid out in the agreement and in this Authorization to Mark. Any further use of the Intertek name for the sale or advertisement of the tested material, product or service must first be approved in writing by Intertek. Initial Factory Assessments and Follow up Services are for the purpose of assuring appropriate usage of the Certification mark in accordance with the agreement, they are not for the purposes of production quality control and do not relieve the Client of their obligations in this respect.

Intertek Testing Services NA Inc.
545 East Algonquin Road, Arlington Heights, IL 60005
Telephone 800-345-3851 or 847-439-5667 Fax 312-283-1672

Standard(s):	Furniture Power Distribution Units [UL 962A:2023 Ed.6]
	Cord reels and multi-outlet assemblies [CSA C22.2#308:2018 Ed.2]
Product:	Furniture Power Distribution Units
Models:	JDL; followed by up to six letter or digit.