

Installation & Assembly

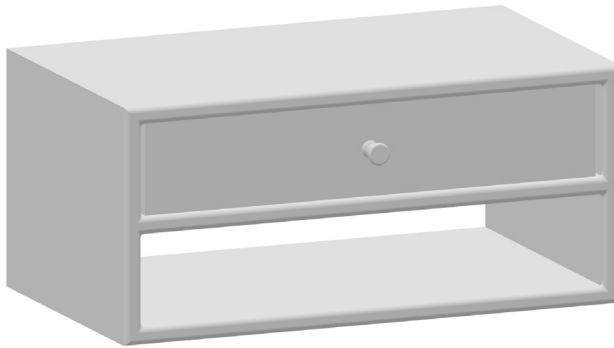

15 : 00

estimated
assembly time



2 or more

people required

Ok, let's
get started!



- Put on mood music!
- To prevent damage to product, use the clean side of package carton or rug as working surface for assembly.
- In the event of missing or damaged parts, delivery problems etc., please reach out to our team. We will be happy to fix the problem!

care guide

- Clean regularly with a soft and dry cloth.
- To protect finish, avoid use of abrasive cleaners.
- Wipe up spills immediately. Please!

ⓘ **While assembling the product, tighten the bolts up to 50%. Once all parts are in place, only then fully tighten the bolts.**



product parts



A
Tabletop
x1

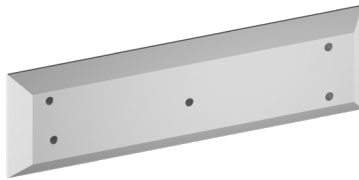

B
Cleat
x1

what's included

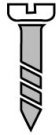

(C) - Screw
40mm
x2



(D) - Wall Plug
x5

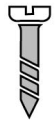

(E) - Screw
35mm
x5

assembly instructions

Friendly Tip: Take a deep breath going in. This may be a tricky part, but nothing too overwhelming. Just follow these steps to the T and the outcome will be worth it!



- ⓘ While assembling the product, tighten the bolts up to 50%. Once all parts are in place, only then fully tighten the bolts.

step 1:

Start by placing the cleat (B) on the wall you want to hang the night-stand (A) on. The cleat hangs with the angled side up and angle facing against the wall. Put a spirit level on it to ensure it is straight aligned with the wall. Adjust if needed. Now, mark points on the wall through the holes on the cleat using a pencil. Ensure that one of the marks comes in front of the stud.

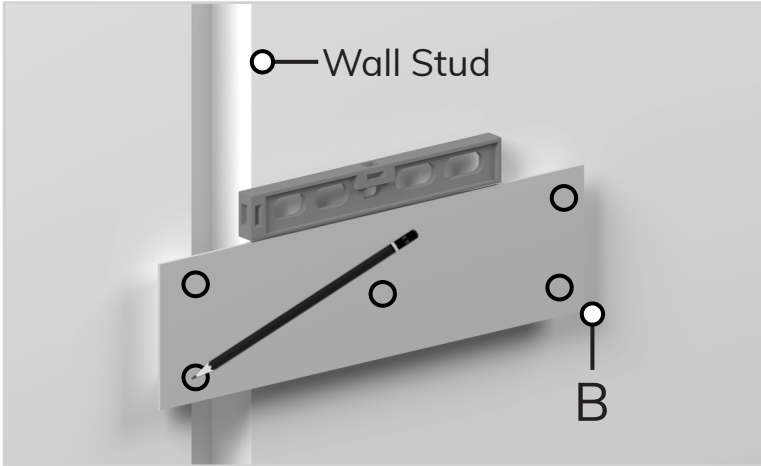

Note: Wall plug is not needed at the location of the stud.

step 2:

Drill holes on the points you just marked.



step 3:

Using a screw driver, Insert wall plugs (D) inside the holes on the drywall.

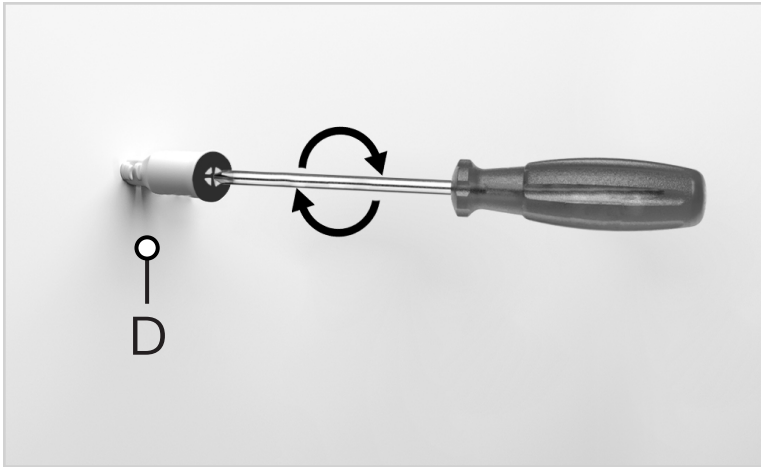

step 4:

Now take the french cleat (B) and fix it in place using screws. For drywall, insert screws (E) on the wall plugs. For stud walls, insert the screws (C). Use a screwdriver to make sure they are secure.

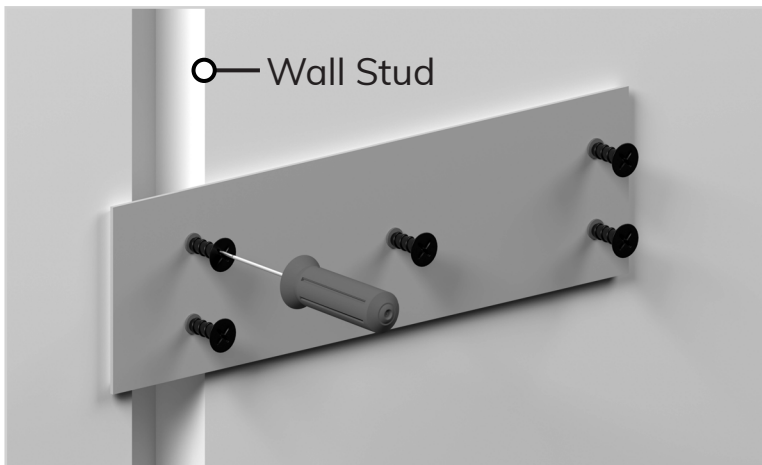

step 5:

Now, take the nightstand and place it on the french cleat. Make sure the slot on the nightstand is aligned with the cleat and not too close to the wall to prevent scratches and damage.

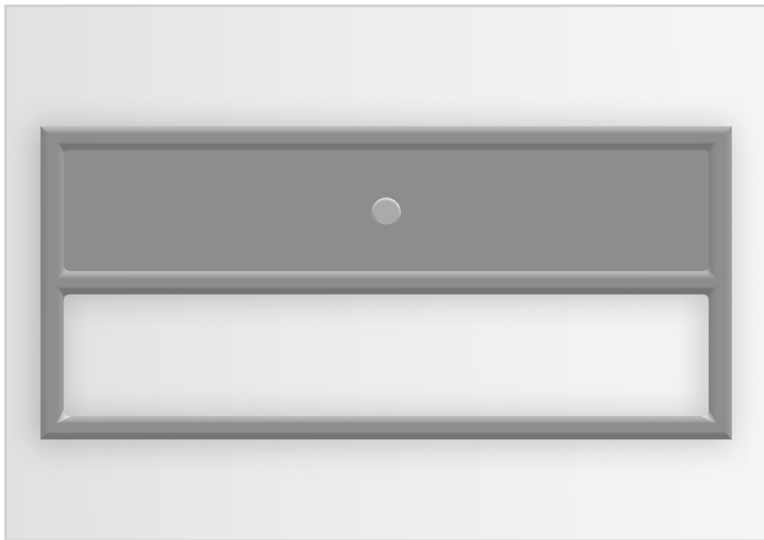
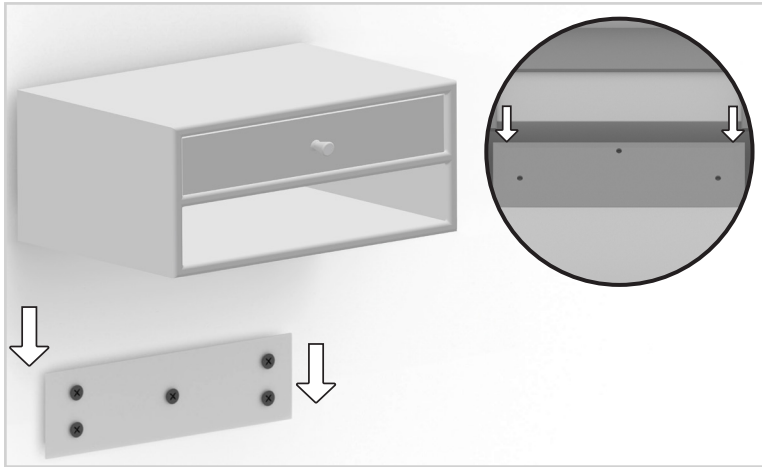

Voila! Your Nightstand is now installed and secure!