

## Instruction Manual

Thank you for shopping with us!







We appreciate your purchase and are ready to be at your service!

If you find parts missing, broken, or hard to put together or when you are not satisfied or have any valuable suggestions, please do not hesitate to contact us first!

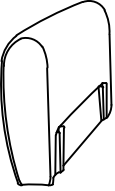
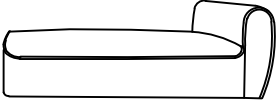
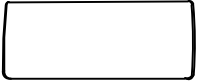
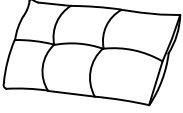
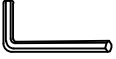
We will definitely give you a satisfactory solution or answer then!

# Accessories list

Note: all the parts or hardware marked with\*are tucked under Right armrest seat frame

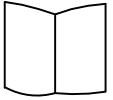
<p>A *</p>  <p>Left armrest(1)</p>	<p>B</p>  <p>Right armrest seat frame(1)</p>	<p>C</p>  <p>Backrest(1)</p>	<p>D</p>  <p>Pillow(2)</p>	<p>E *</p>  <p>M5x95x35wrench(1)</p>	
<p>F *</p>  <p>Sofa foot(4)</p>	<p>G *</p>  <p>8x65 screw(4)</p>	<p>H *</p>  <p>16mm gasket(4)</p>	<p>I *</p>  <p>38mm Woolenmat(4)</p>	<p>J *</p>  <p>Latch(2)</p>	 <p>Instruction Manual(1)</p>

## STEP 1:

Remove the accessories from the bottom of the sofa

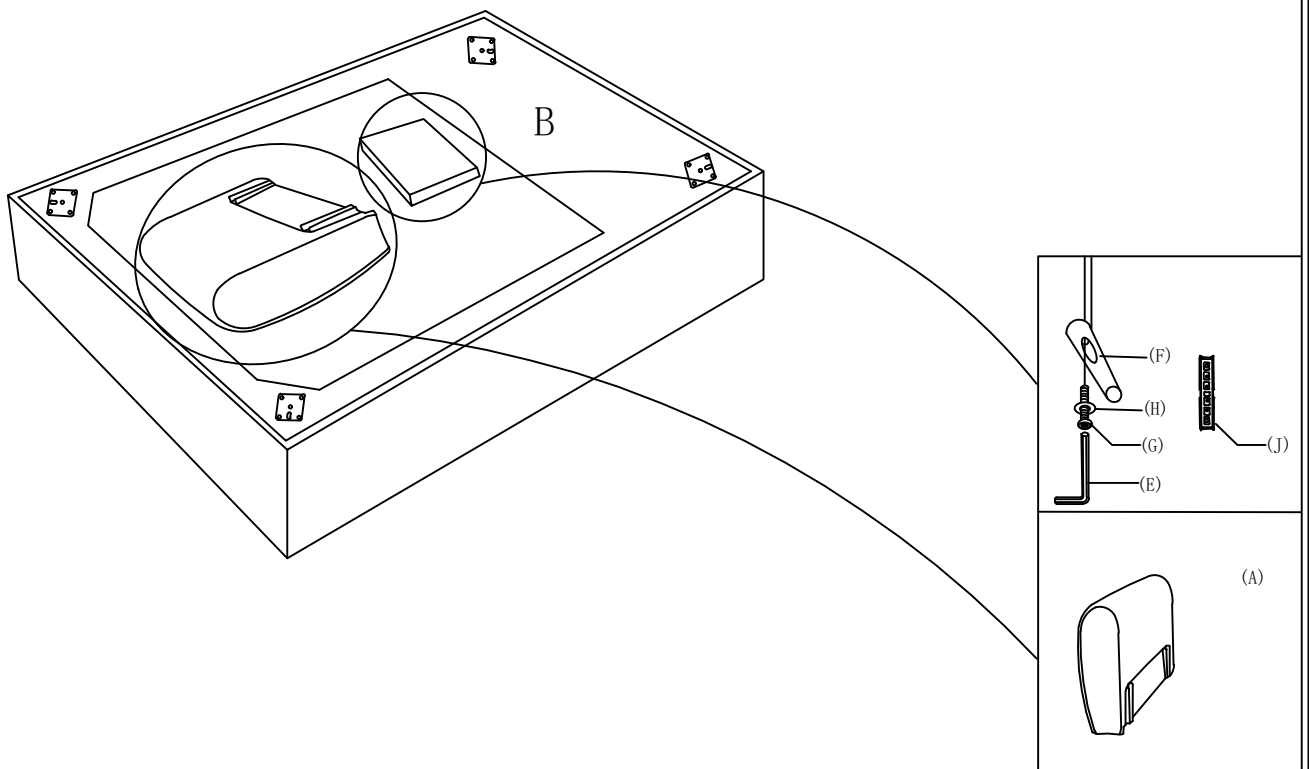

STEP 2:

Insert the left armrest into the sofa frame

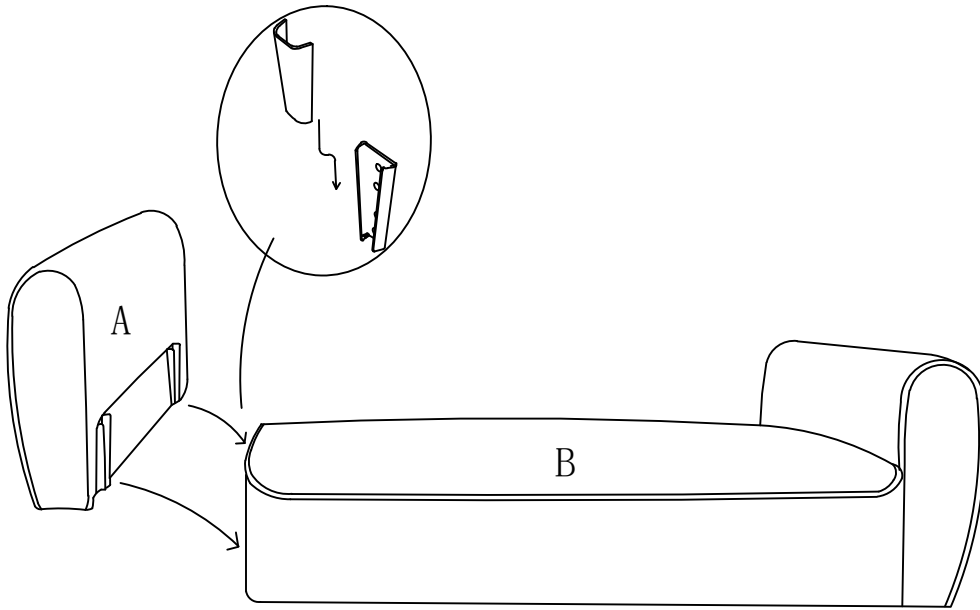

STEP 3:

Insert the latch into the backrest first, then insert the backrest into the sofa frame

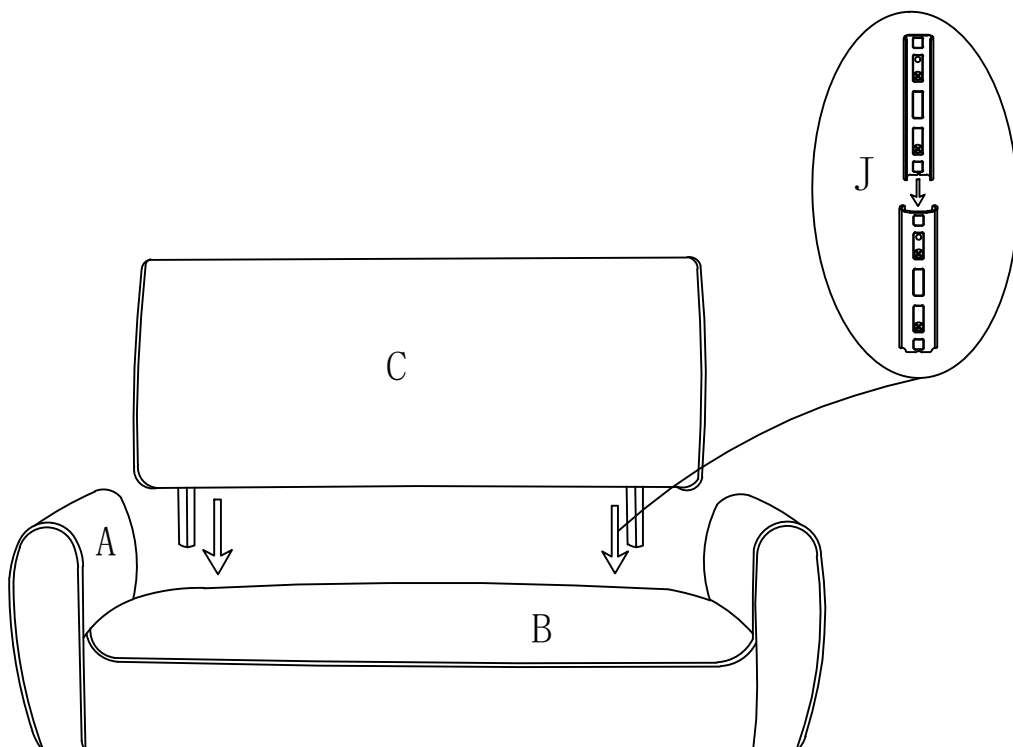

STEP 4:

Turn over the sofa and install the sofa feet

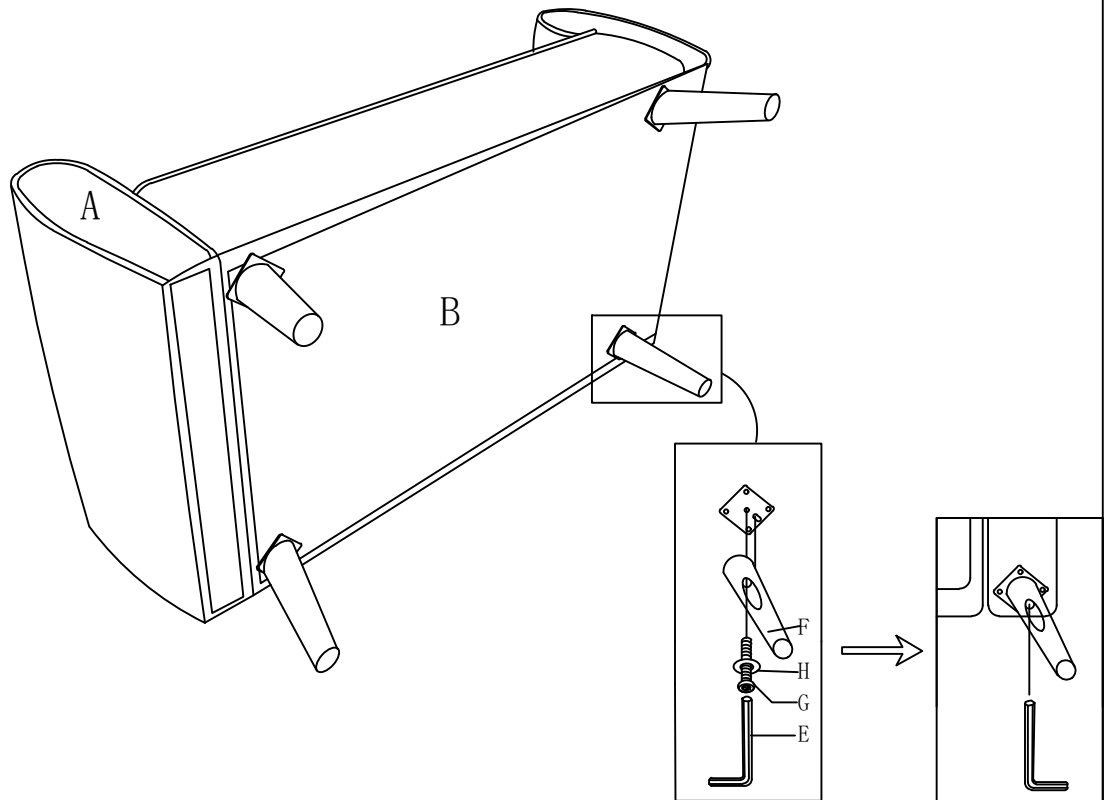

STEP 5 :

Put the pillows on the sofa and the sofa assembly completed

