

IMPORTANT NOTE

- 1. PLACE ALL PARTS ON A CLEAN AND SMOOTH SURFACE SUCH AS A RUG OR CARPET TO AVOID THE PARTS FROM BEING SCRATCHED
- 2. BEFORE YOU BEGIN, KINDLY FOLLOW THE ASSEMBLY INSTRUCTIONS STEP BY STEP
- 3. DO NOT TIGHTEN ALL SCREWS AND BOLTS UNTIL THE BED IS FULLY SET-UP

REMARQUE IMPORTANTE

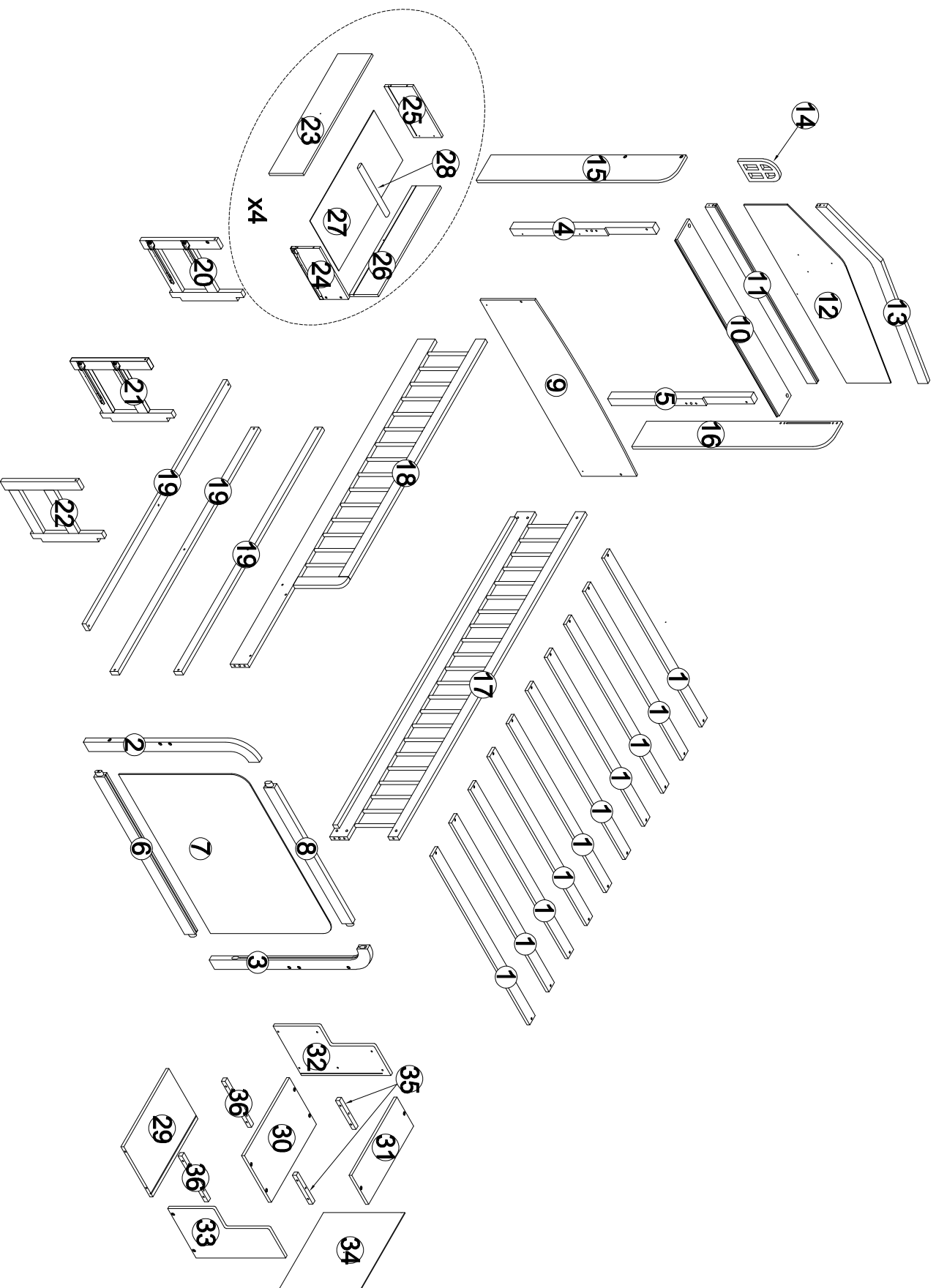



- 1. PLACEZ TOUTES LES PIÈCES SUR UNE SURFACE PROPRE ET LISSE COMME UN TAPIS OU UNE MOQUETTE POUR ÉVITER QUE LES PIÈCES NE SOIENT RAYÉES
- 2. AVANT DE COMMENCER, VEUILLEZ SUIVRE LES INSTRUCTIONS D'ASSEMBLAGE ÉTAPE PAR ÉTAPE
- 3. NE SERREZ PAS TOUTES LES VIS ET LES BOULONS AVANT QUE LE LIT SOIT ENTièrement INSTALLÉ

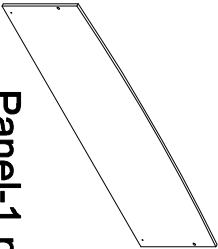
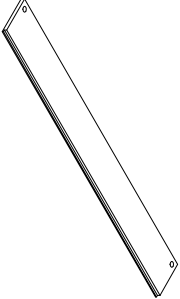
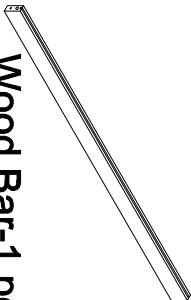
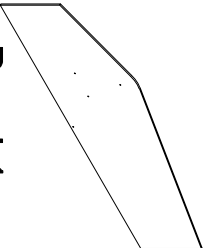
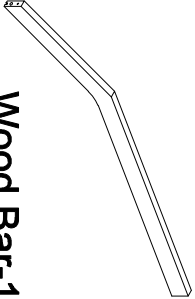
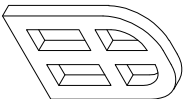
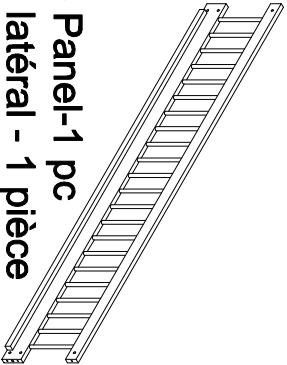
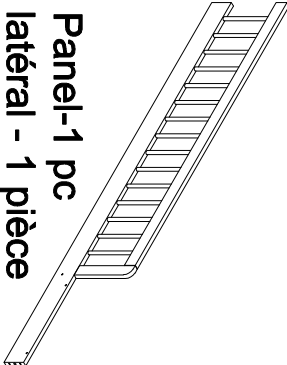
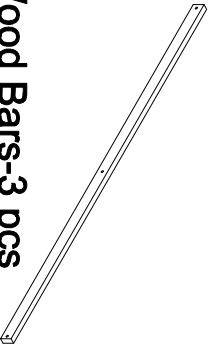
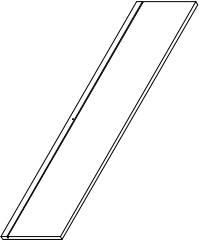
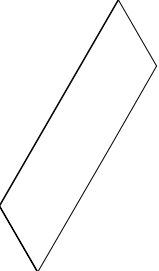

Box 1:SW09011-1
Boîte 1 : SW09011-1

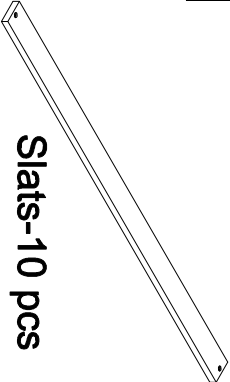
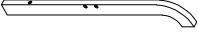
<p>9</p>  <p>Panel-1 pc Panneau - 1 pièce</p>	<p>10</p>  <p>Panel-1 pc Panneau - 1 pièce</p>	<p>11</p>  <p>Wood Bar-1 pc Barre en bois - 1 pièce</p>
<p>12</p>  <p>Panel-1 pc Panneau - 1 pièce</p>	<p>13</p>  <p>Wood Bar-1 pc Barre en bois - 1 pièce</p>	<p>14</p>  <p>Panel-1 pc Panneau - 1 pièce</p>
<p>17</p>  <p>Side Panel-1 pc Panneau latéral - 1 pièce</p>	<p>18</p>  <p>Side Panel-1 pc Panneau latéral - 1 pièce</p>	<p>19</p>  <p>Wood Bars-3 pcs Barre en bois - 3 pièces</p>
<p>26</p>  <p>Drawer-Back Panels-4 pcs Panneaux arrière de tiroir - 4 pièces</p>	<p>27</p>  <p>Drawer-Bottom Panels-4 pcs Panneaux de fond de tiroir - 4 pièces</p>	

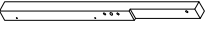
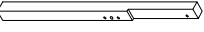
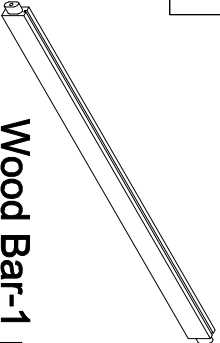
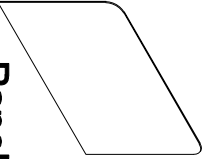
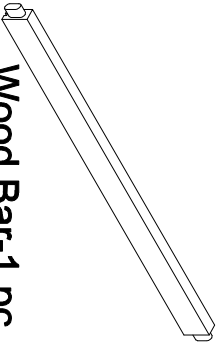
Box 2:SW09011-2(PART LIST & HW LIST)
Boîte 2 : SW09011-2 (LISTE DES PIÈCES ET LISTE DU MATÉRIEL)

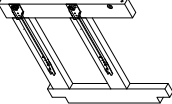
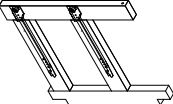
<p>1</p>  <p>Slats-10 pcs Lattes-10 pièces</p>	<p>2</p>  <p>Leg-1 pc Jambe-1 pièce</p>	<p>3</p>  <p>Leg-1 pc Jambe-1 pièce</p>
<p>4</p>  <p>Leg-1 pc Jambe-1 pièce</p>	<p>5</p>  <p>Leg-1 pc Jambe-1 pièce</p>	<p>6</p>  <p>Wood Bar-1 pc Barre en bois - 1 pièce</p>
<p>7</p>  <p>Panel-1 pc Panneau - 1 pièce</p>	<p>8</p>  <p>Wood Bar-1 pc Barre en bois - 1 pièce</p>	<p>15</p>  <p>Panel-1 pc Panneau - 1 pièce</p>
<p>16</p>  <p>Panel-1 pc Panneau - 1 pièce</p>	<p>20</p>  <p>Frame-1 pc Cadre-1 pièce</p>	<p>21</p>  <p>Frame-1 pc Cadre-1 pièce</p>

**Box 2:SW09011-2(PART LIST & HW LIST)
Boîte 2 : SW09011-2 (LISTE DES PIÈCES ET LISTE DU MATÉRIEL)**

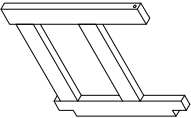
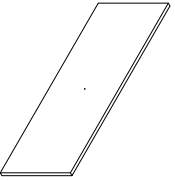
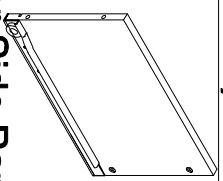
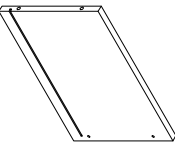
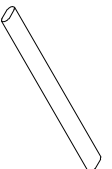
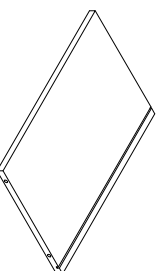
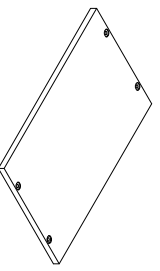
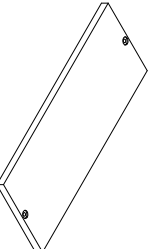
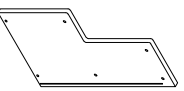
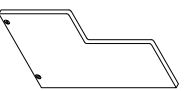
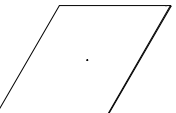
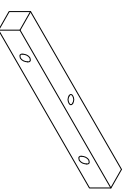
<p>22</p>  <p>Frame-1 pc Cadre-1 pièce</p>	<p>23</p>  <p>Drawer-Front Panels-4 pcs Panneaux avant de tiroir - 4 pièces</p>	<p>24</p>  <p>Drawer-Side Panels-4 pcs Panneaux latéraux de tiroir - 4 pièces</p>
<p>25</p>  <p>Drawer-Side Panels-4 pcs Panneaux latéraux de tiroir - 4 pièces</p>	<p>28</p>  <p>Drawer-Support Bottom Panels-4 pcs Panneaux inférieurs de support de tiroir - 4 pièces</p>	<p>29</p>  <p>Panel-1 pc Panneau - 1 pièce</p>
<p>30</p>  <p>Panel-1 pc Panneau - 1 pièce</p>	<p>31</p>  <p>Panel-1 pc Panneau - 1 pièce</p>	<p>32</p>  <p>Panel-1 pc Panneau - 1 pièce</p>
<p>33</p>  <p>Panel-1 pc Panneau - 1 pièce</p>	<p>34</p>  <p>Panel-1 pc Panneau - 1 pièce</p>	<p>35</p>  <p>Wood beetles-2 pcs Coléoptères du bois - 2 pièce</p>

Box 2:SW09011-2(PART LIST & HW LIST)

Boîte 2 : SW09011-2 (LISTE DES PIÈCES ET LISTE DU MATÉRIEL)

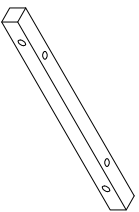

36



Wood beetles-2 pcs

Coléoptères du bois - 2 pièce

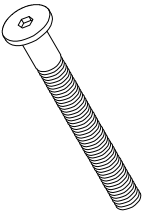
HARDWARE LIST (Box 2:SW09011-2)
LISTE DU MATÉRIEL (Box 2:SW09011-2)

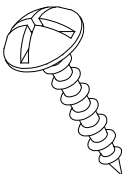
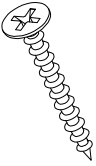
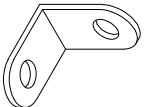
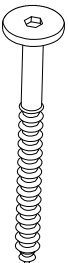
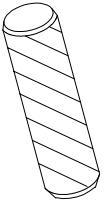
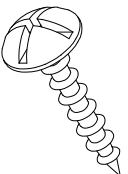
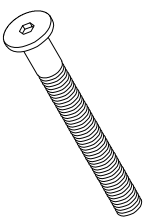
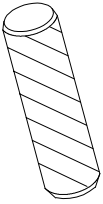
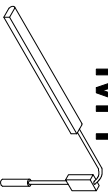
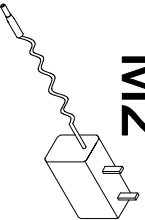
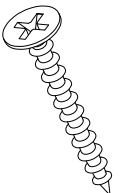
<p>A</p> 	<p>B</p> 	<p>C</p> 
<p>Hex-Head bolts Ø1/4" x 90 mm-8 pcs Boulons à tête hexagonale Ø1/4" x 90 mm -8 pièces</p>	<p>Horizontal-Hole bolts Ø1/4" x 13 mm -13 pcs Boulons à trous horizontaux Ø1/4" x 13 mm - 13 pièces</p>	<p>Wood Screws M4 x20 mm-2 pcs Vis à bois M4 x 20 mm - 2 pièces</p>
<p>D</p> 	<p>E</p> 	<p>F</p> 
<p>Screws Ø3.5 x 12 mm-24 pcs Vis Ø3.5 x 12 mm-24 pièces</p>	<p>Steel Bracks-12 pcs Supports en acier - 12 pièces</p>	<p>Screws 1/4"x50 mm-15 pcs Vis 1/4"x50 mm-15 pièces</p>
<p>G</p> 	<p>H</p> 	<p>K</p> 
<p>Wood dowel Ø8 x 30 mm-4 pcs Cheville en bois Ø8 x 30 mm-4 pièces</p>	<p>Wood Screws M4 x15 mm-5 pcs Vis à bois M4 x 15 mm - 5 pièces</p>	<p>Hex-Head bolts Ø1/4" x 70 mm-5 pcs Boulons à tête hexagonale Ø1/4" x 70 mm -5 pièces</p>
<p>L</p> 	<p>M</p> <p>M1</p>  <p>M2</p> 	<p>N</p> 
<p>Wood dowel Ø10 x 40 mm-4 pcs Cheville en bois Ø10 x 40 mm-4 pièces</p>	<p>Led Light-1 pc Lampe LED - 1 pièce</p>	<p>Wood Screws M4 x 30 mm-42 pcs Vis à bois M4 x 30 mm - 42 pièces</p>

P



Screws 1/4"x65 mm-3 pcs
Vis 1/4"x50 mm-3 pièces

HARDWARE LIST (Box 2:SW09011-2)

LISTE DU MATÉRIEL (Box 2:SW09011-2)

Q

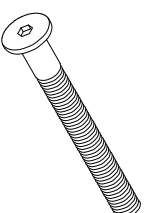

Hex-Head bolts Ø1/4" x 30 mm-21 pcs
Boulons à tête hexagonale Ø1/4" x 30 mm
-21 pièces

R

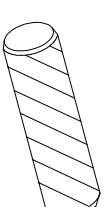

Wood dowel Ø6 x 25 mm-16 pcs
Cheville en bois Ø6 x 25 mm-16 pièces

U

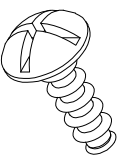

Ø1/6" x 25 mm-4 pcs
Ø1/6" x 25 mm-4 pièces

V



Handle Wood-4 pcs
Manche bois-4 pièces

W

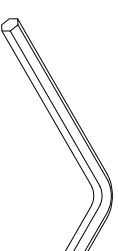

Allen Key-1 pc
Clé Allen - 1 pièce

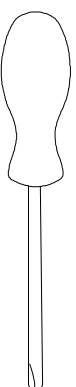



Assembly Tools Required (Not Included)
Outils d'assemblage requis (non inclus)

STEP 1:

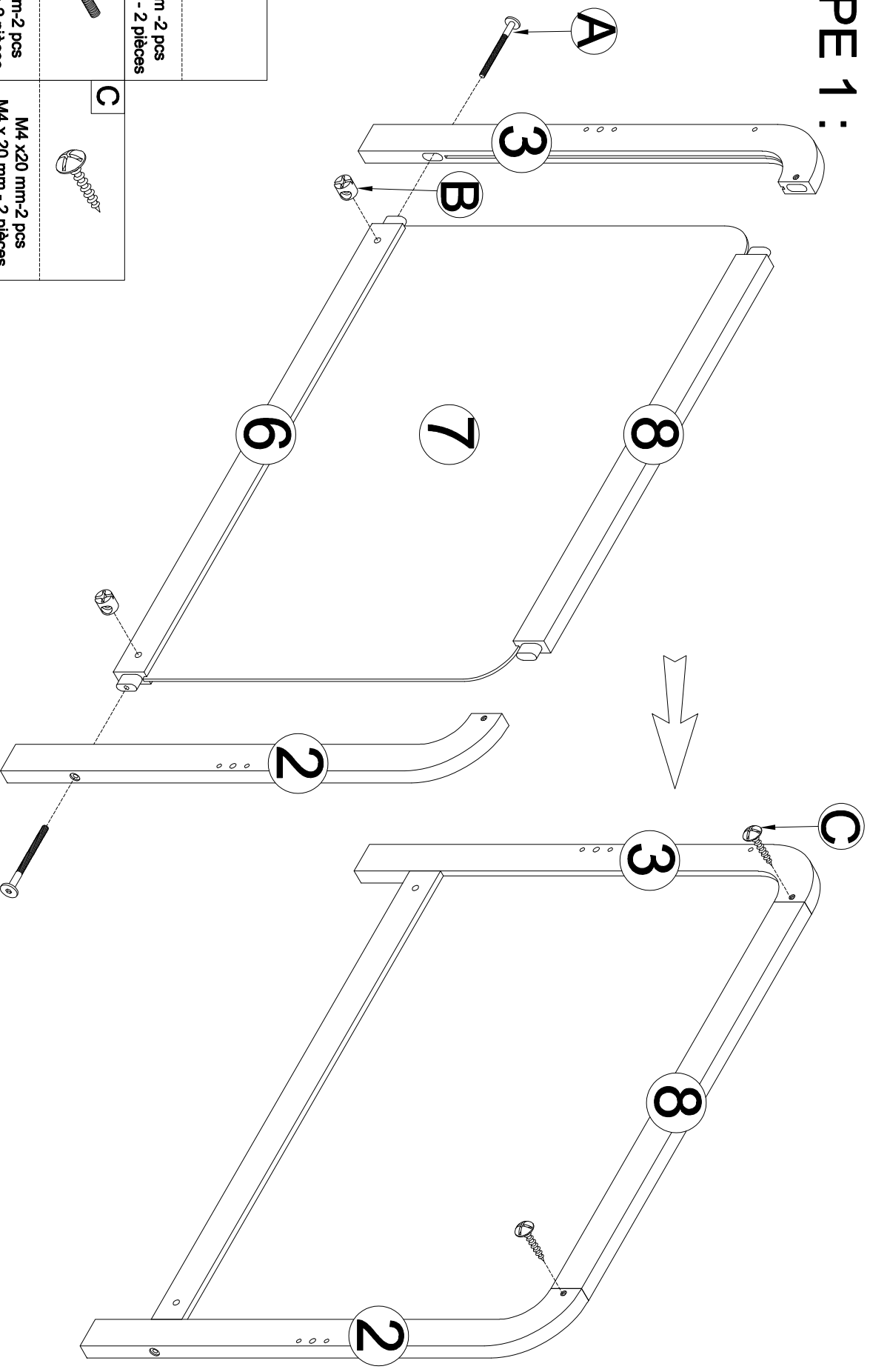
ÉTAPE 1 :



B	 Ø1/4" x 13 mm - 2 pcs Ø1/4" x 13 mm - 2 pièces
----------	--

A	 Ø1/4" x 90 mm - 2 pcs Ø1/4" x 90 mm - 2 pièces
----------	--

C	 M4 x20 mm - 2 pcs M4 x 20 mm - 2 pièces
----------	---

STEP 2-1:
ÉTAPE 2-1 :

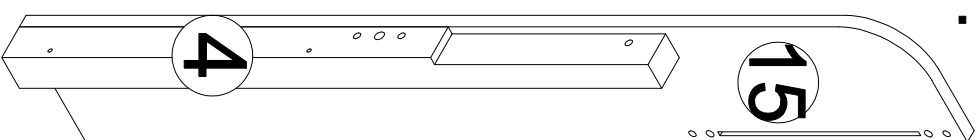

View 1
Vue 1

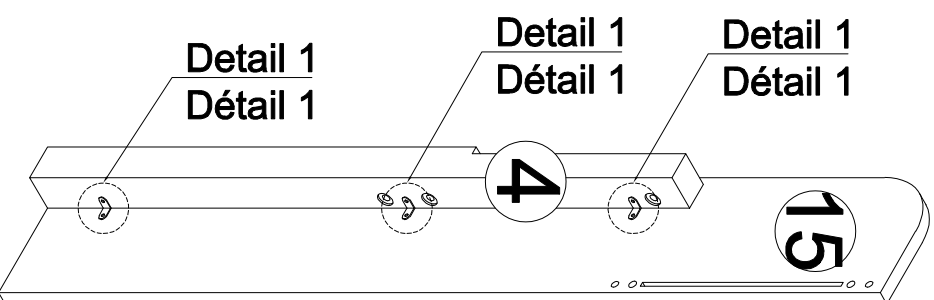

View 2
Vue 2

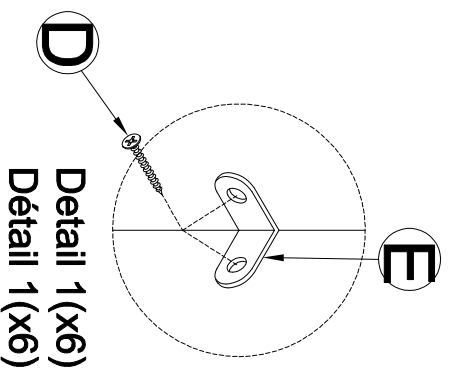

Detail 1 (x6)
Détail 1 (x6)

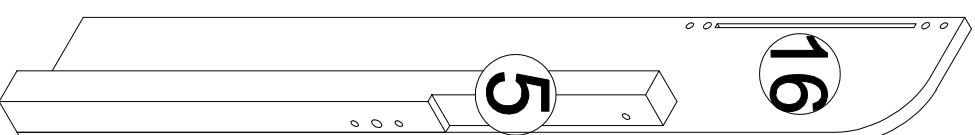

View 1
Vue 1

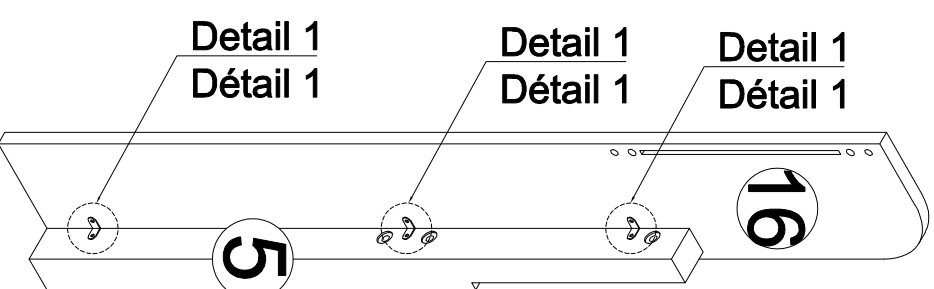

View 2
Vue 2

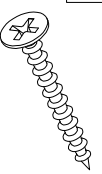

D

Ø3.5 x 12 mm-12 pcs
Ø3.5 x 12 mm-12 pièces

E



Steel Bracks-6 pcs
Supports en acier - 6 pièces

STEP 2-3:

ÉTAPE 2-3 :

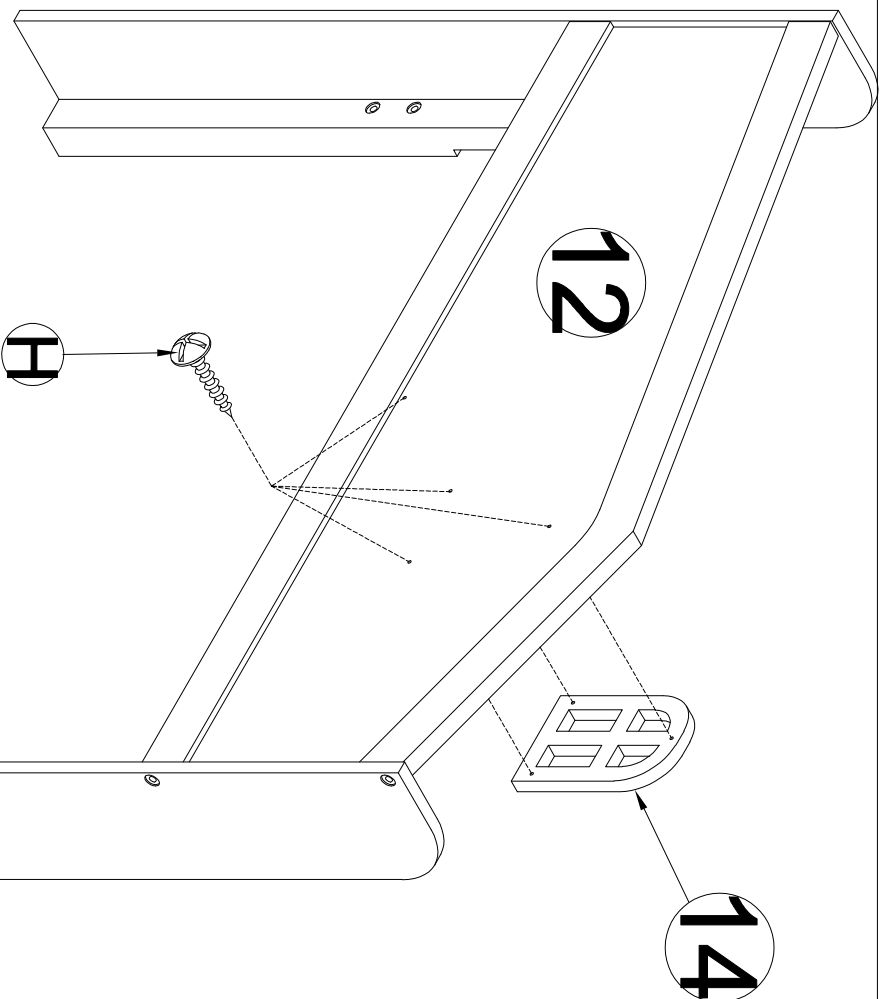

H



M4 x15 mm-4 pcs
M4 x 15 mm - 4 pièces

STEP 3:
ÉTAPE 3 :

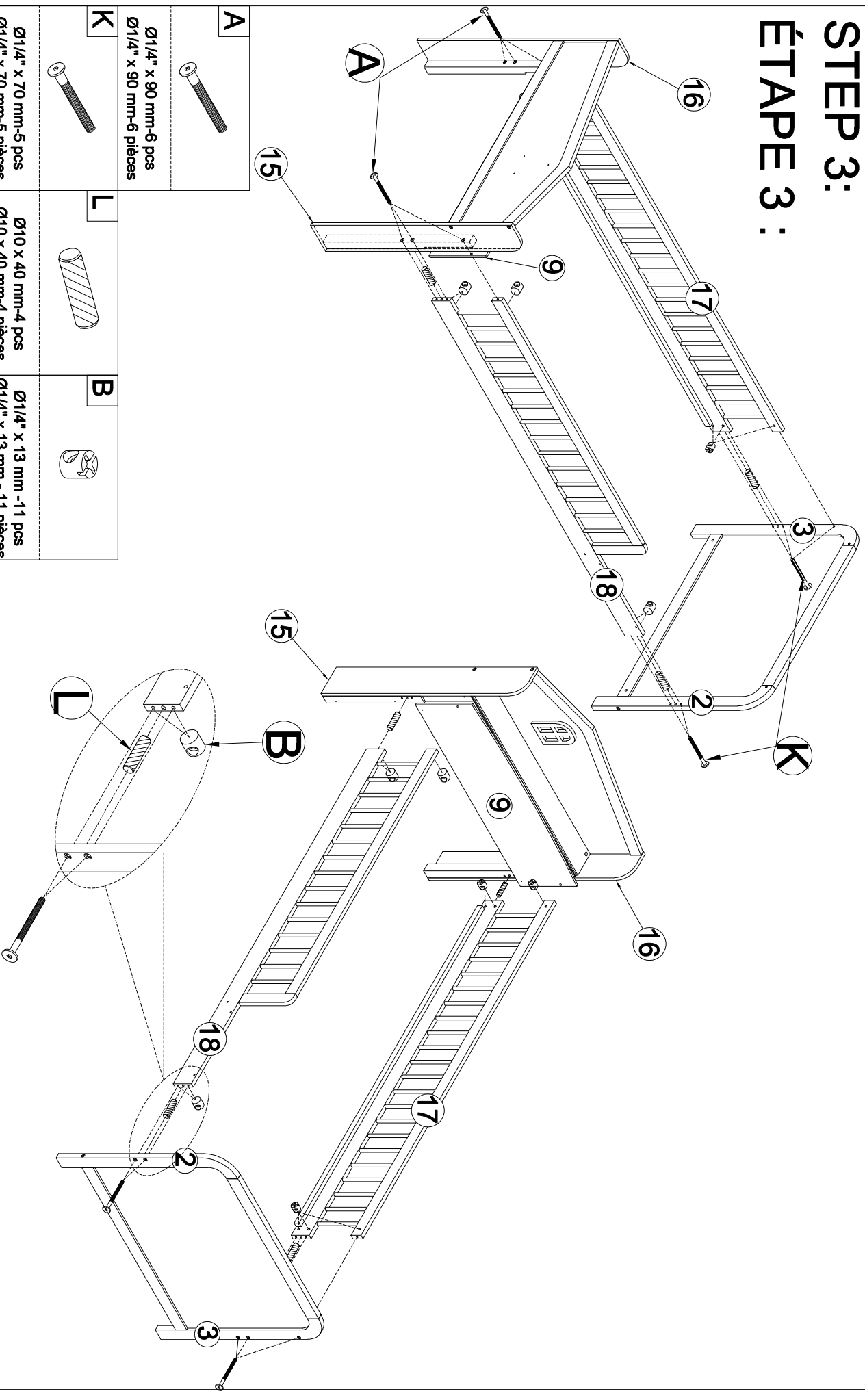

STEP 4:

ÉTAPE 4 :

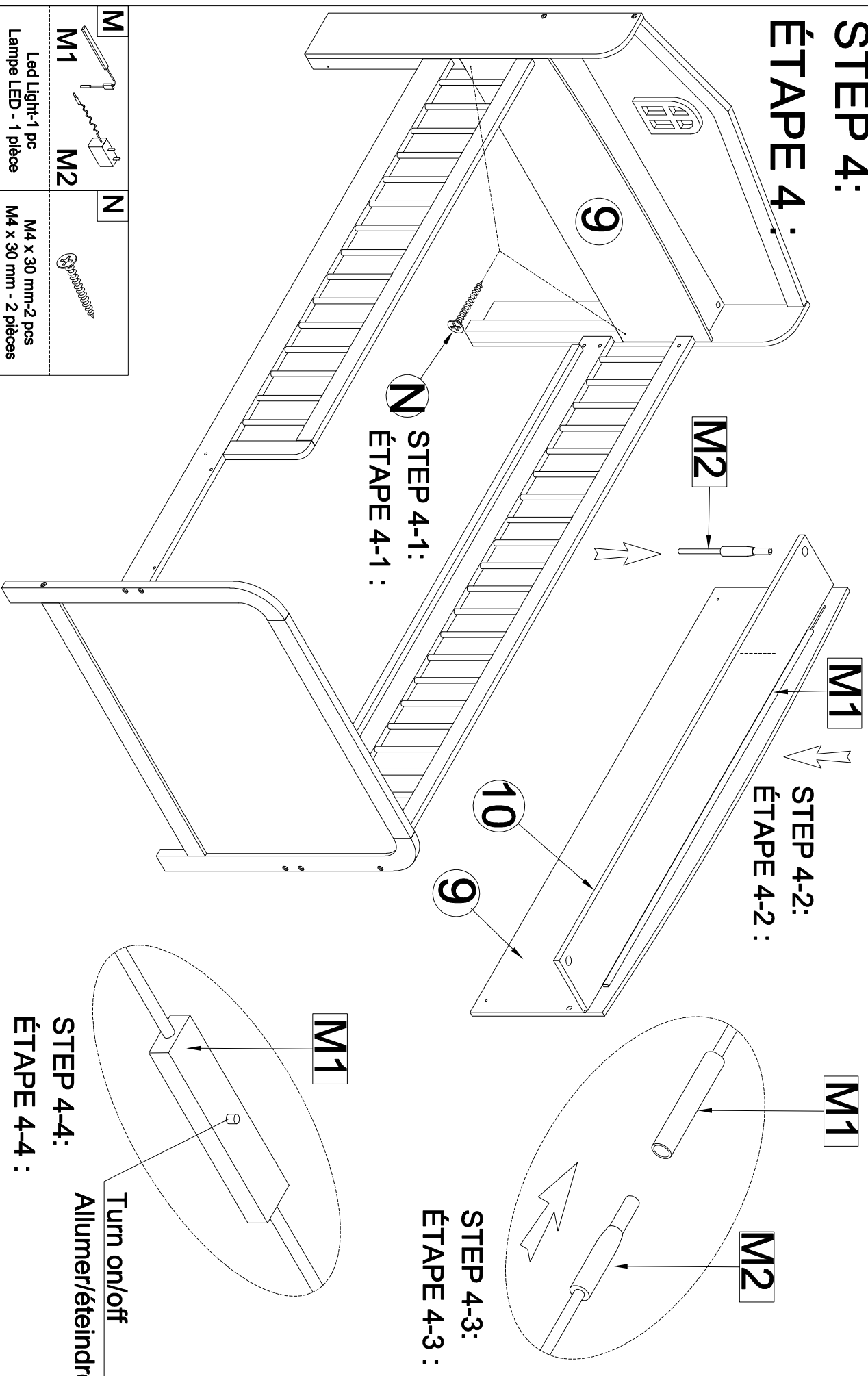

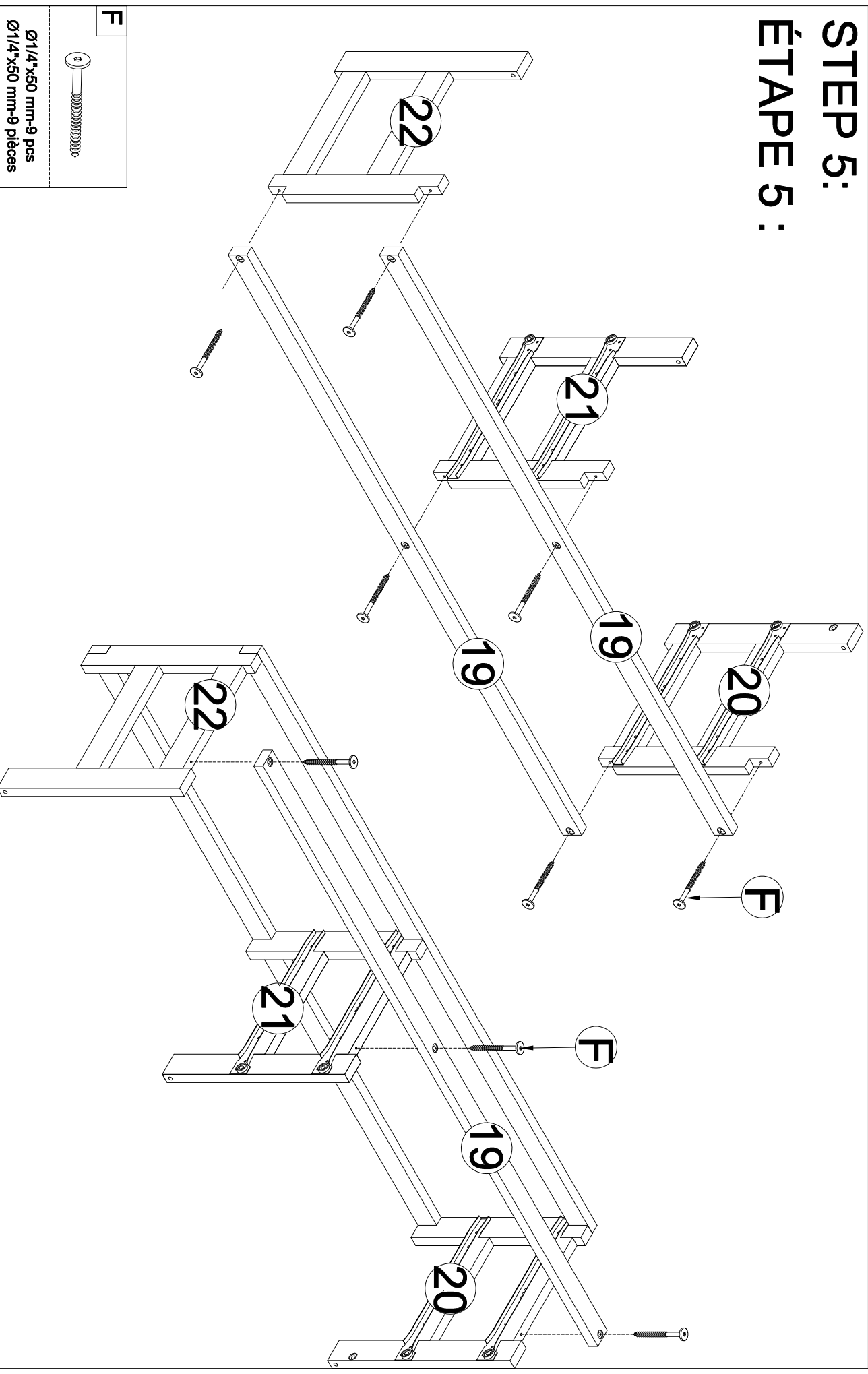

STEP 5:
ÉTAPE 5 :

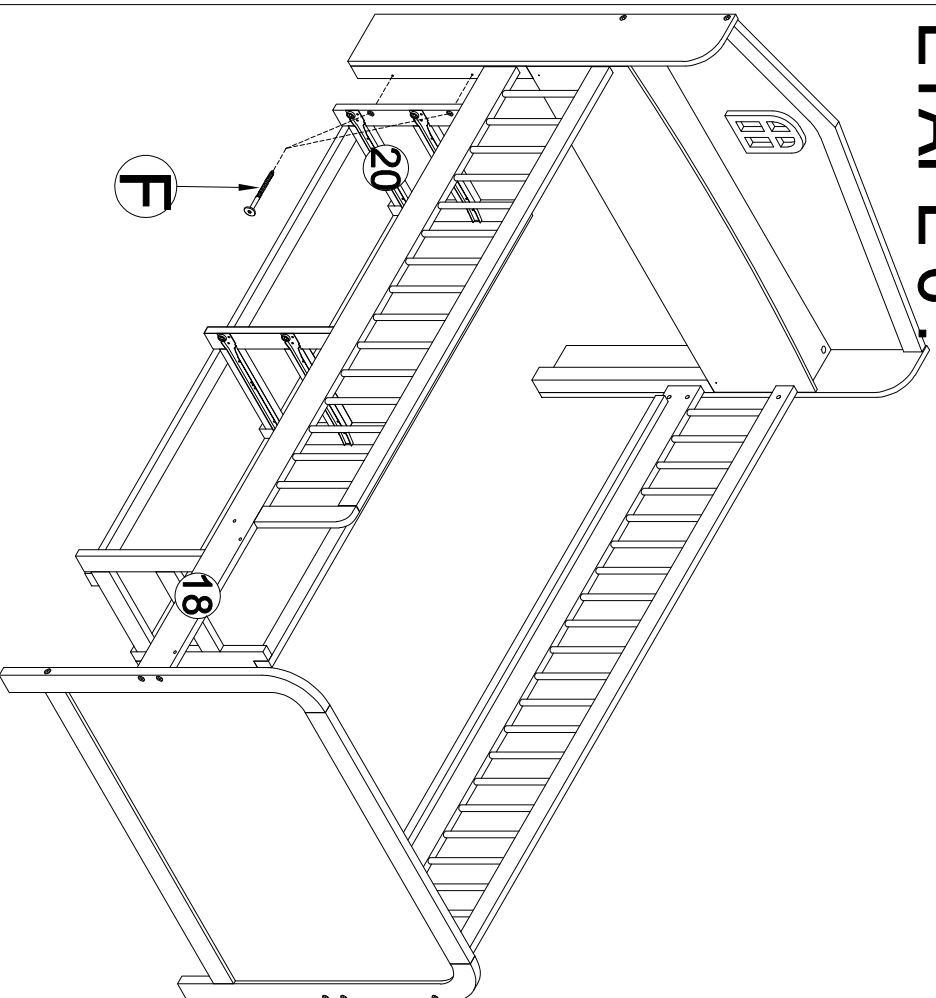

STEP 6:

ÉTAPE 6 :



F		P	
	Ø1/4"x50 mm-2 pcs		Ø1/4"x65 mm-3 pcs
	Ø1/4"x50 mm-2 pièces		Ø1/4"x65 mm-3 pièces

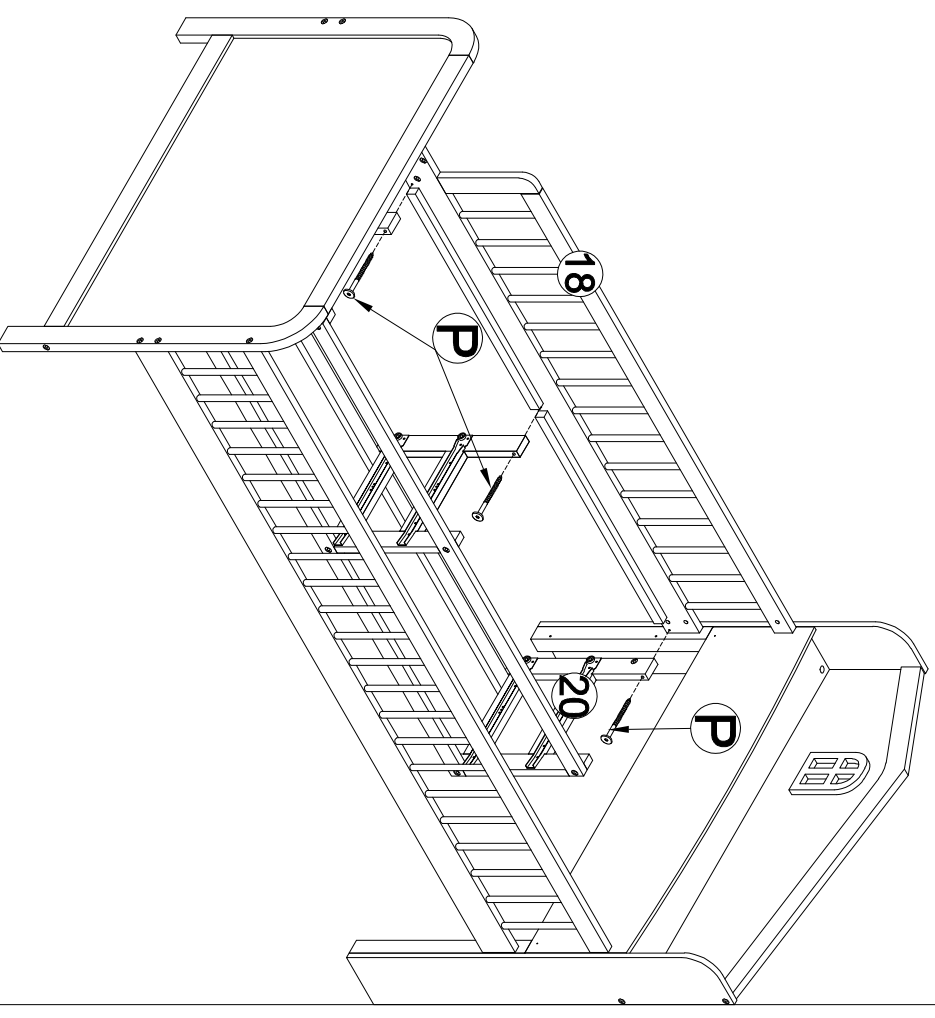

STEP 7-1:

ÉTAPE 7-1 :

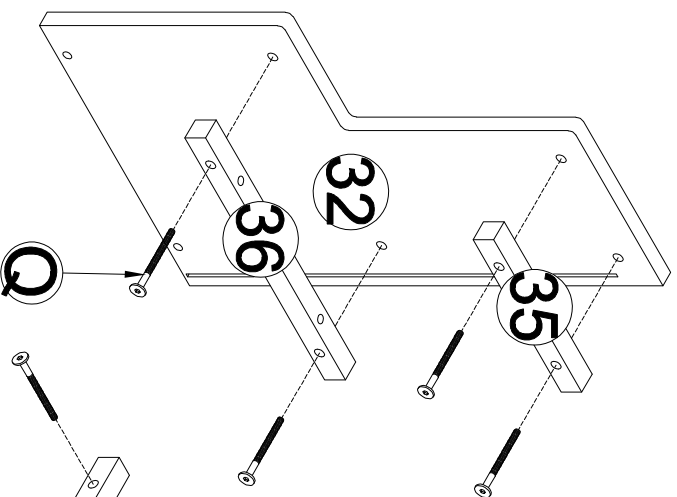

STEP 7-2:

ÉTAPE 7-2 :

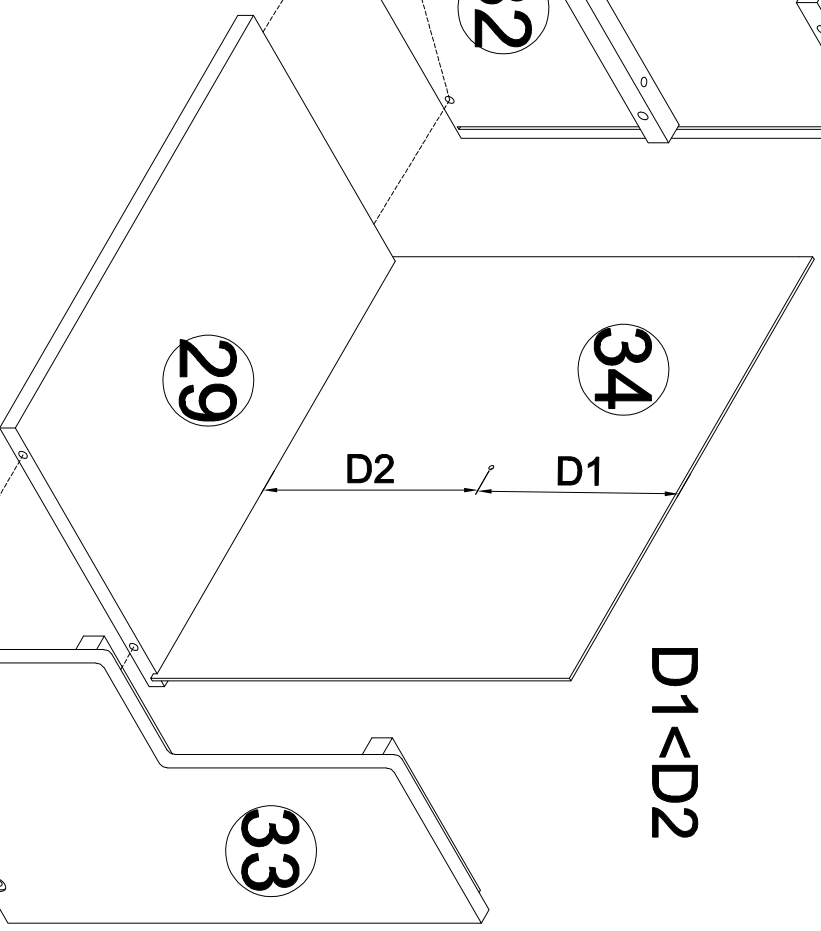
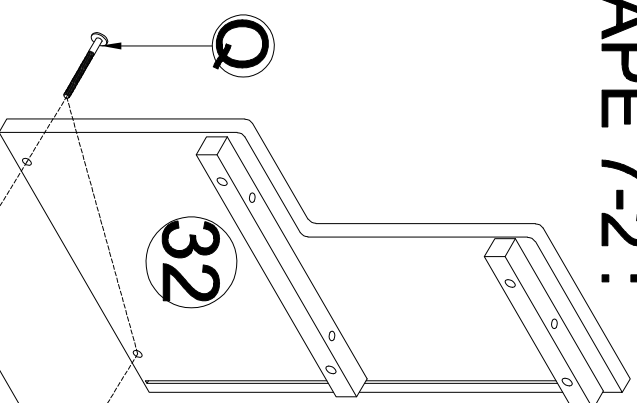

Q



Ø1/4" x 30 mm-8 pcs
Ø1/4" x 30 mm-8 pièces

Q



Ø1/4" x 30 mm-4 pcs
Ø1/4" x 30 mm-4 pièces

STEP 7-3:

ÉTAPE 7-3 :

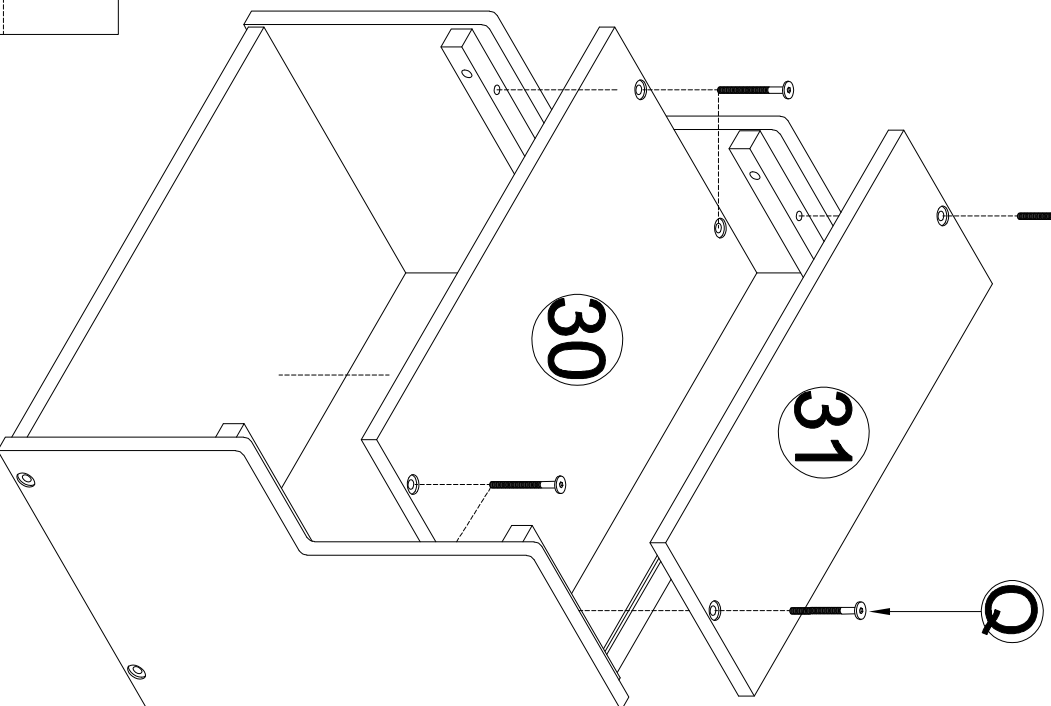

Q



Ø1/4" x 30 mm-6 pcs
Ø1/4" x 30 mm-6 pièces

STEP 7-4:

ÉTAPE 7-4 :

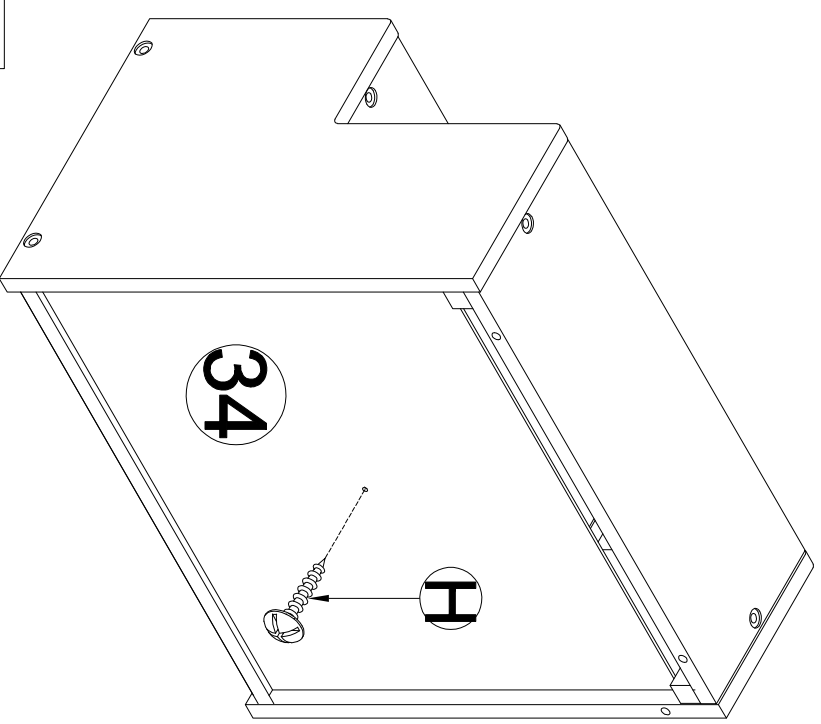

H



M4 x15 mm-1 pc
M4 x 15 mm - 1 pièce

STEP 8:
ÉTAPE 8 :

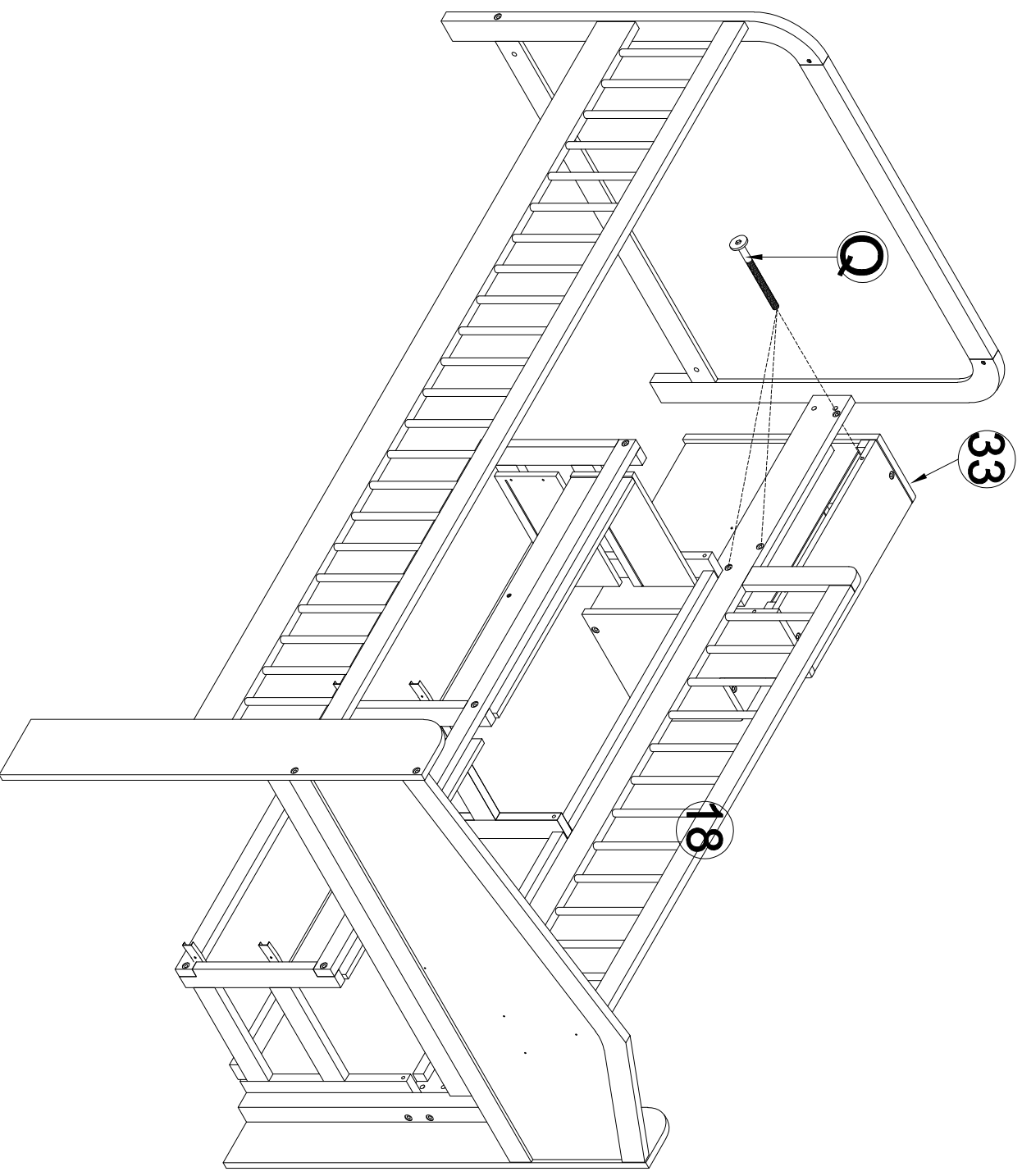

Q
Ø1/4" x 30 mm-3 pcs
Ø1/4" x 30 mm-3 pièces

STEP 9:
ÉTAPE 9 :

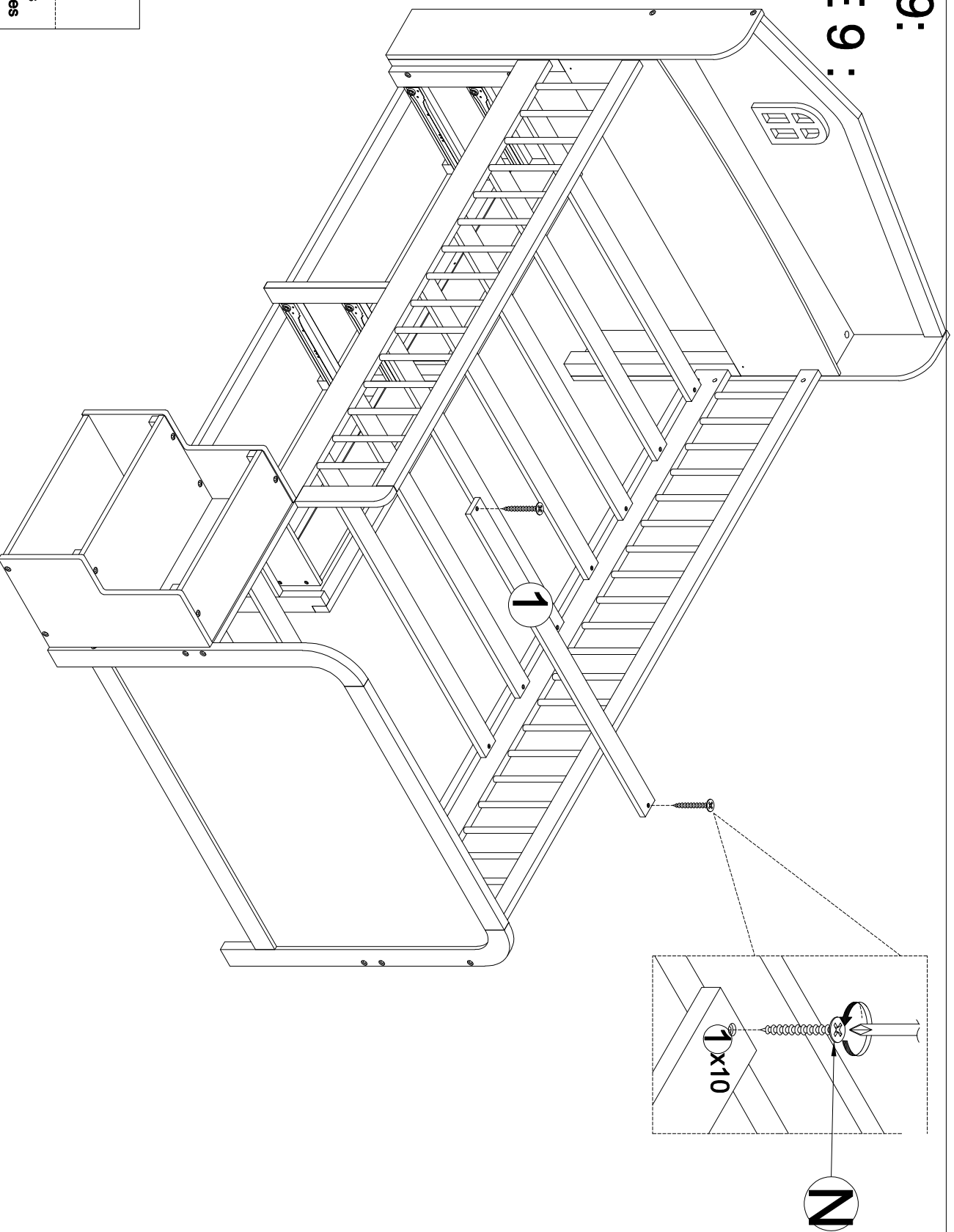

N





M4 x 30 mm-20 pcs
M4 x 30 mm - 20 pièces

STEP 10-1:
ÉTAPE 10-1 :

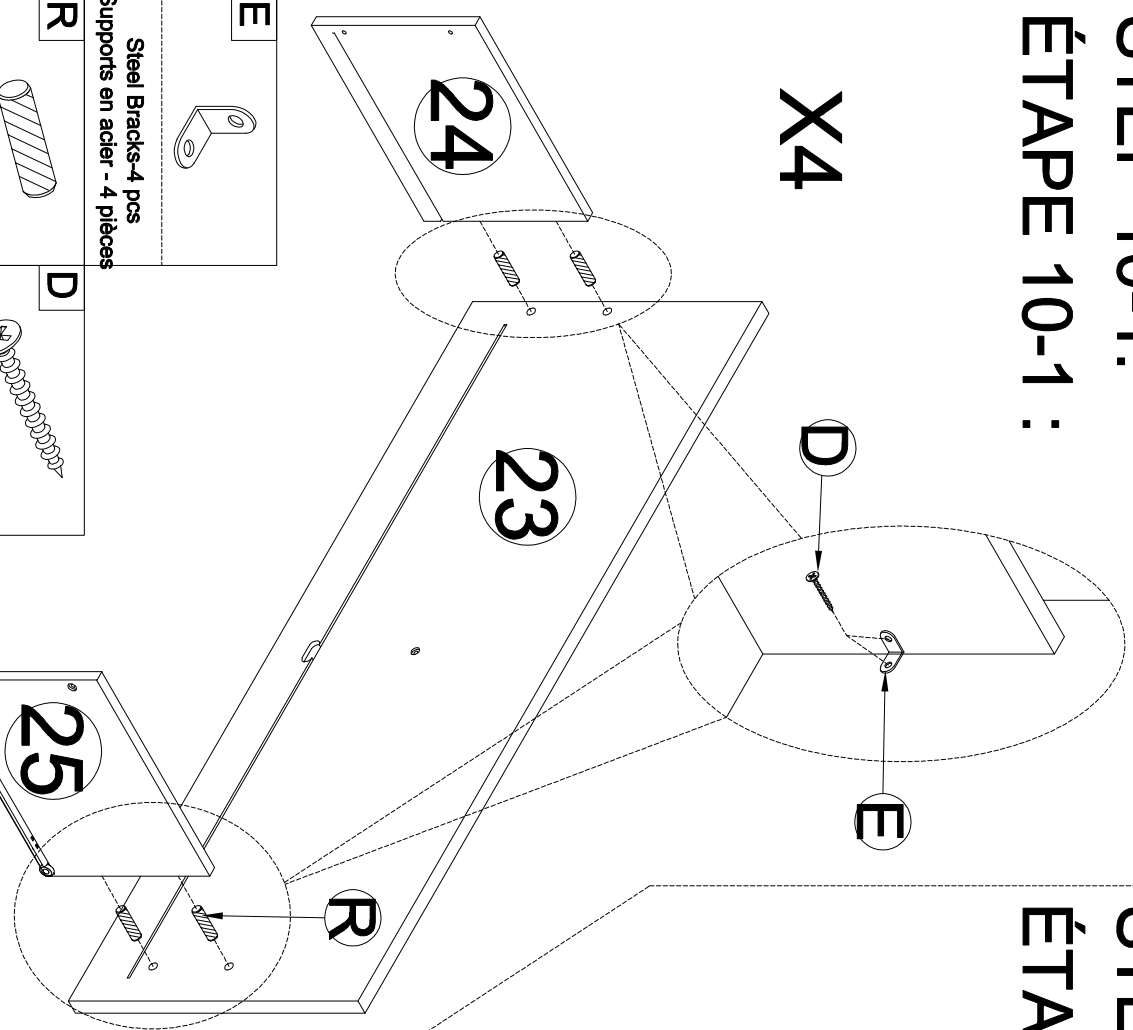
X4

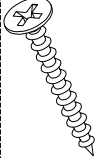

E		Steel Brackets-4 pcs Supports en acier - 4 pièces
R		Ø6 x 25 mm-16 pcs Ø6 x 25 mm-16 pièces

D		Ø3.5 x 12 mm-8 pcs Ø3.5 x 12 mm-8 pièces
---	---	---

STEP 10-2:
ÉTAPE 10-2 :

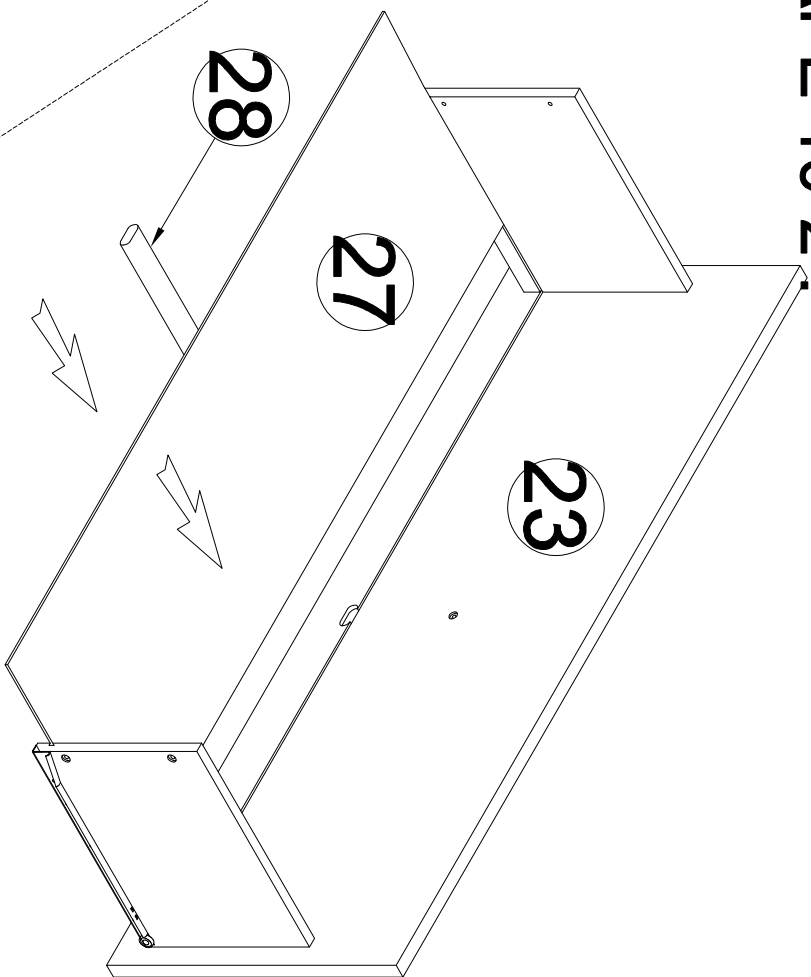

X4

STEP 10-3:

ÉTAPE 10-3 :

STEP 10-4:

ÉTAPE 10-4 :

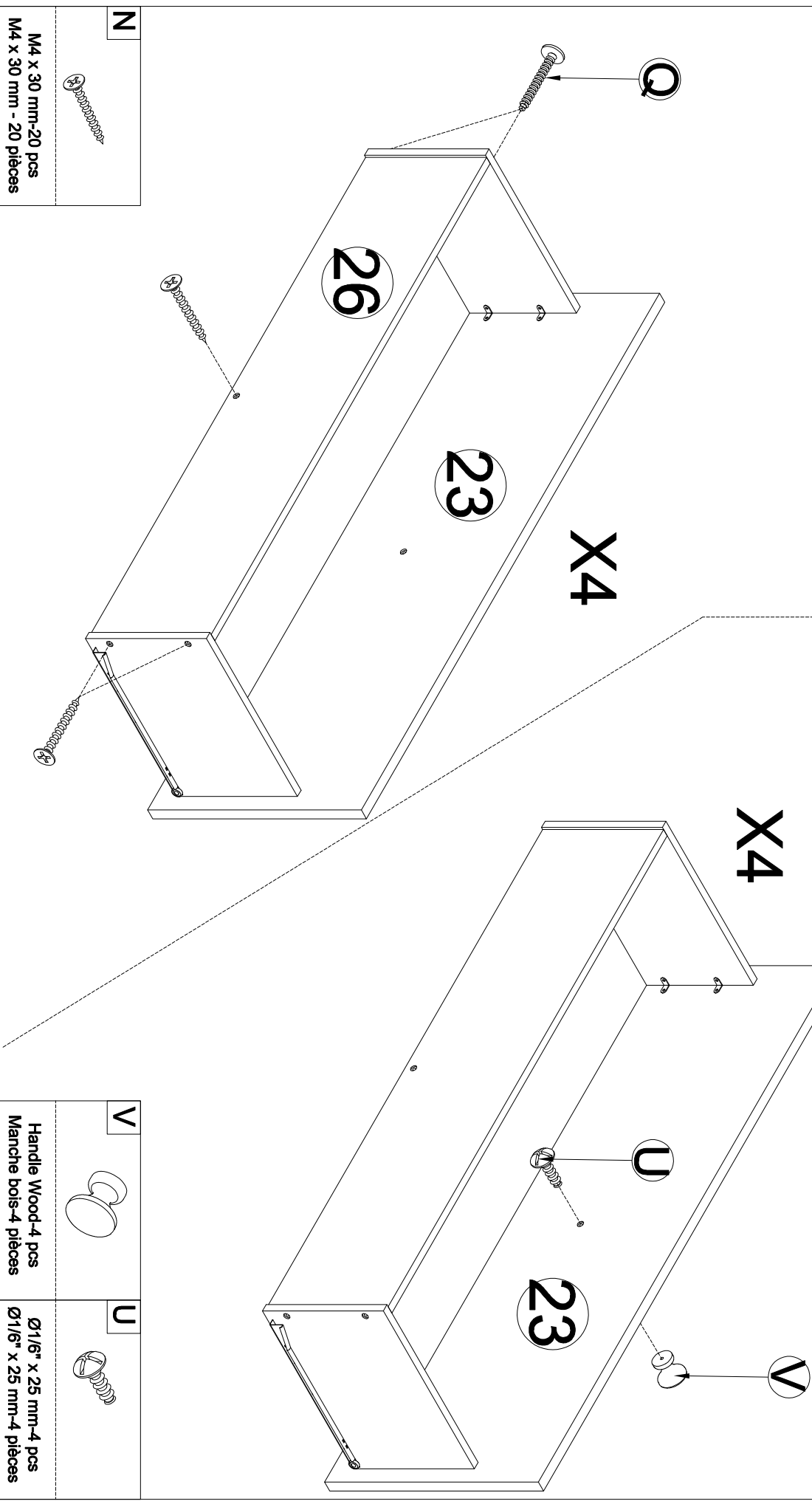

N



M4 x 30 mm-20 pcs
M4 x 30 mm - 20 pièces

V



Handle Wood-4 pcs
Manche bois-4 pièces

U



Ø1/6" x 25 mm-4 pcs
Ø1/6" x 25 mm-4 pièces

**STEP 11:
ÉTAPE 11 :**

