

Installation Instructions

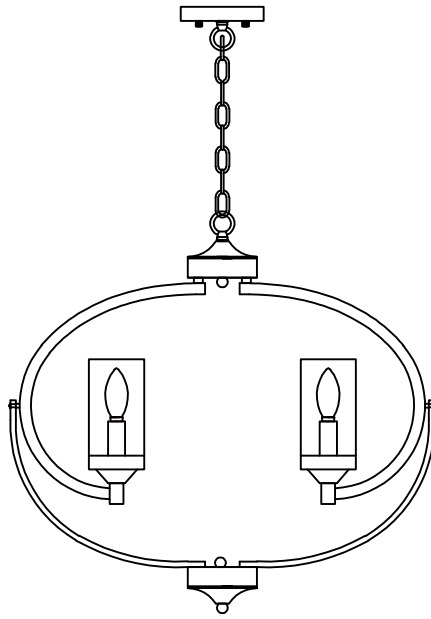

5 x Max 60W Candelabra Base

Safety Information

READ AND SAVE THESE INSTRUCTIONS

1. For your protection and safety, carefully read and understand the information provided in this manual completely before attempting to assemble, install, or operate this product. Failure to do so could lead to electrical shock, fire, or other injuries that could be hazardous or even fatal.
2. Before touching any wire, use a voltage tester to make sure it not live.
3. When replacing fuses, turn off the main power first. Make sure your hands and feet are dry, and place one hand behind your back to prevent electricity from making a complete circuit through your chest. Touch the plug fuse only by its insulated rim. Remove cartridge fuses with a fuse puller
4. Use tools with insulated handles and ladders made of wood or fiberglass.
5. To protect children, place a safety cover over any unused outlets.



DANGER: Before starting installation of this fixture or removal of a previous fixture, disconnect the power by turning off the circuit breaker, removing the fuse at the fuse box, or tripping the breaker that controls that circuit. Tape a sign to the panel warning others to leave the circuit alone while you work.



CAUTION: CONSULT A QUALIFIED ELECTRICIAN IF YOU HAVE ANY ELECTRICAL QUESTIONS. If you have any non-electrical questions about this fixture please contact our customer service via the distributor where you purchased this product from. We will be more than happy to assist.

Pre-Installation

PLANNING INSTALLATION

Read all instructions before installing.

To avoid damaging this product, place it on a soft, non-abrasive surface, such as carpet or cardboard.

TOOLS REQUIRED (NOT INCLUDED)



Phillips
Screwdriver



Wire
Stripper

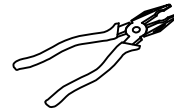

Pliers



Safety
Goggles



Electrical
Tape

HARDWARE INCLUDED

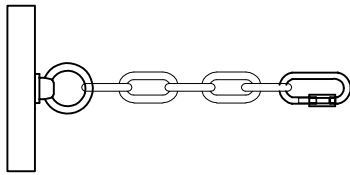

Canopy and hanging chain 1PCS

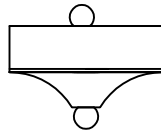

cover box(A) 1PCS

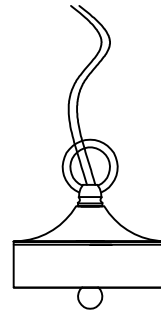

cover box(B) 1PCS



3PCS



3PCS



3PCS



screw 5PCS



cap nut 2PCS



screw driver 1PCS

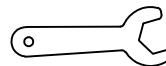

wrench 1PCS



2PCS



1PCS



2PCS



glass 5PCS



nut 10PCS



Serrated shims 10PCS

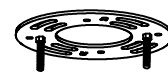

hanging board 1PCS

Assembly Instructions

Assembly of this fixture will be accomplished by first determining the length of stem or chain required, attaching the mounting plate to the junction box, making all necessary electrical connections, hanging the fixture from the ceiling and then installing the fixture

Safety Warning

Read wiring and grounding instruction and any additional directions. Turn power supply off during installation. If new wiring is required, consult a qualified electrician or local authorities for code requirements.

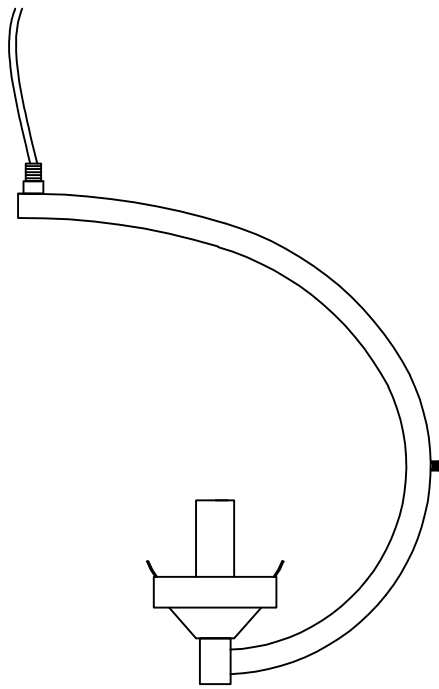

lamp arm(A) 5PCS

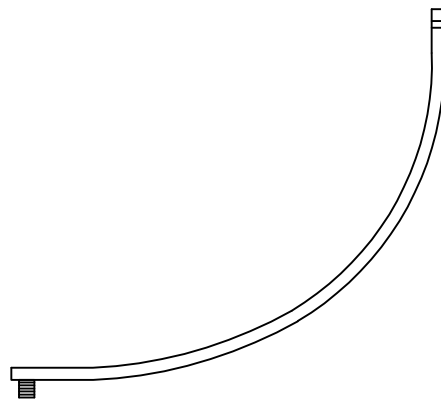

lamp arm(B) 5PCS



3PCS



3PCS



3PCS



2PCS



1PCS



2PCS

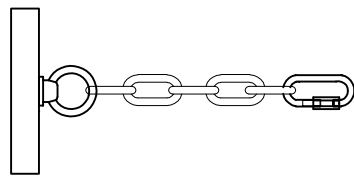

Canopy and hanging chain 1PCS

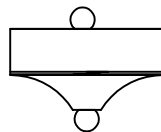

cover box(A) 1PCS

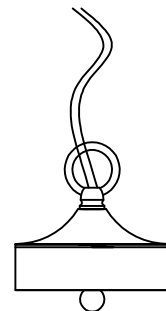

cover box(B) 1PCS



screw 5PCS



cap nut 2PCS



screw driver 1PCS

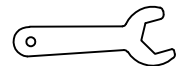

wrench 1PCS

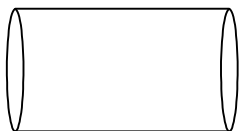

glass 5PCS



nut 10PCS



Serrated shims 10PCS

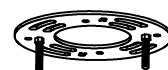

hanging board 1PCS

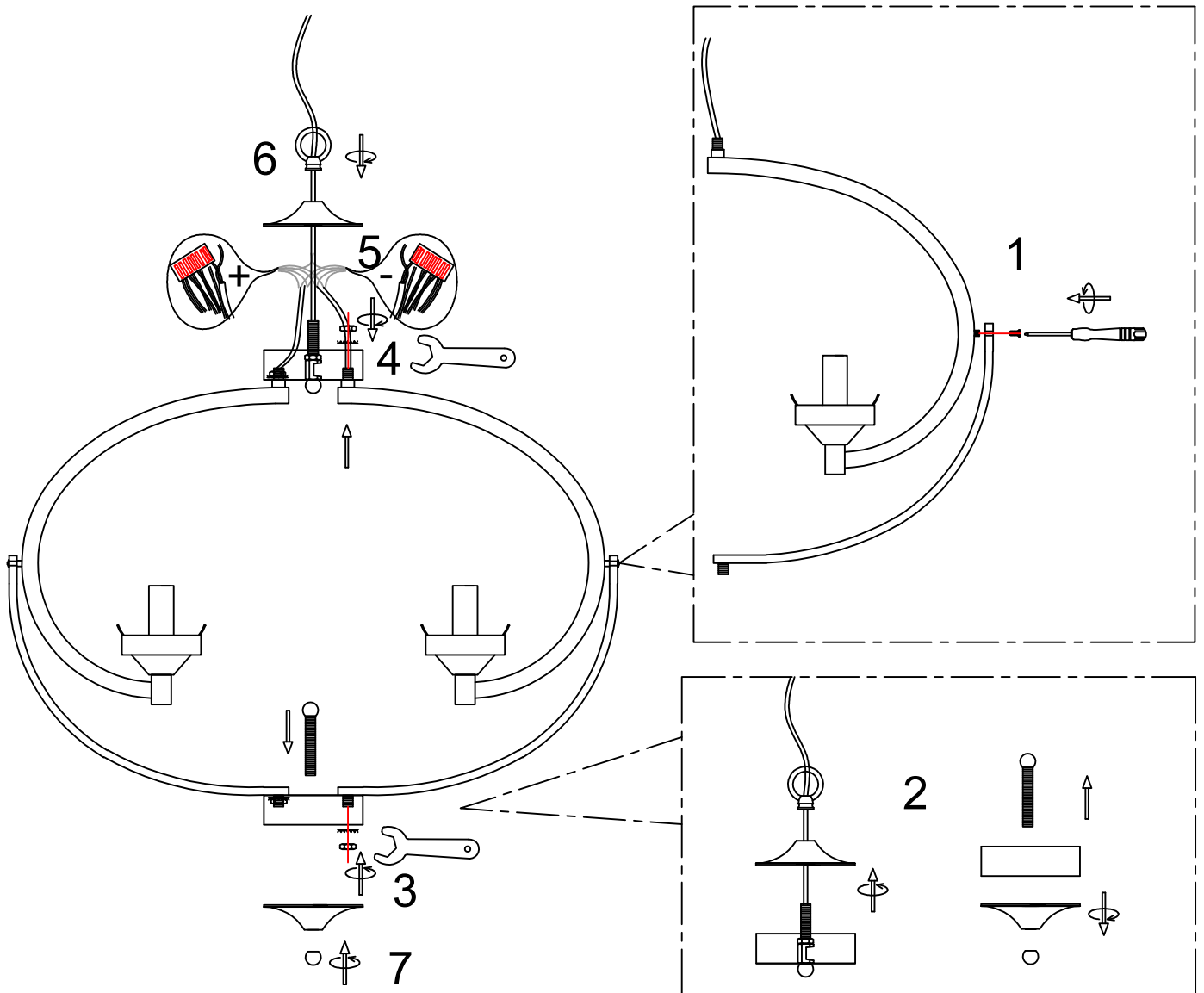

1. Screws go through the lamp arm (B) and lock in the lamp arm (A).
2. Remove the cover of the cover box.
3. First insert the lamp arm (B) through the cover box (A), then secure the lamp arm (B) with the serrated shims and nut.
4. First plug the fixture wires and lamp arm(A) into the cover box(B), then secure the lamp arm(A) with serrated shims and nuts.
5. Distinguish between positive and negative terminals and insert the fixture wires correctly into the terminal block.
6. Pass the wires through the horn cover and closed ring first, then screw the closed closed ring to fix it.
7. The ball nut with the threaded tube goes through the cover box (A) and the flared cover and is then secured with the ball nut.

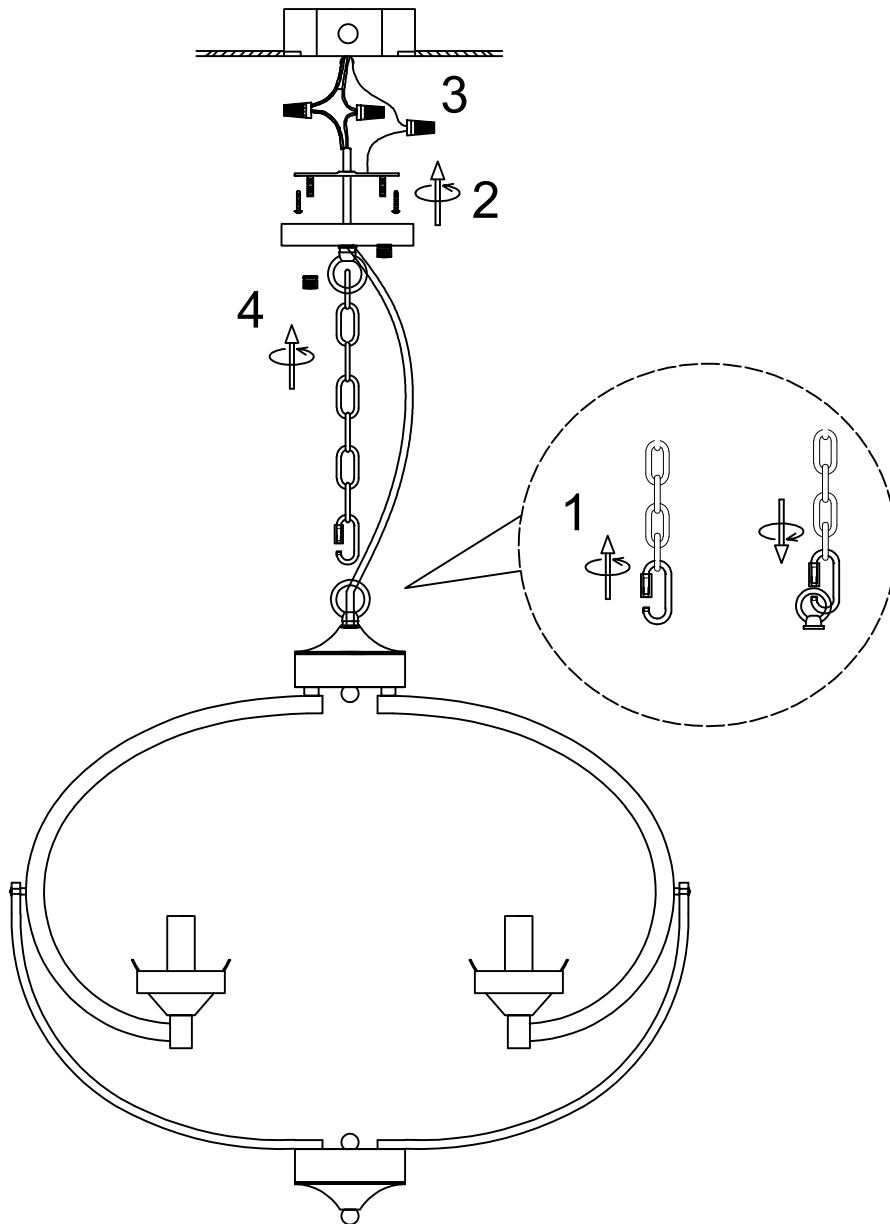

1. Loosen the nut on the suspension chain so that the chain passes through the closing ring, then tighten the nut and run the wires through the canopy.
2. Remove the mounting bracket and secure it to the ceiling junction box with screws.
3. Connect wires from lighting fixtures to household circuits, distinguishing between positive and negative terminals
4. After aligning the canopy with the screws on the mounting brackets, the canopy passes through the screws and is tightened with cap nuts.

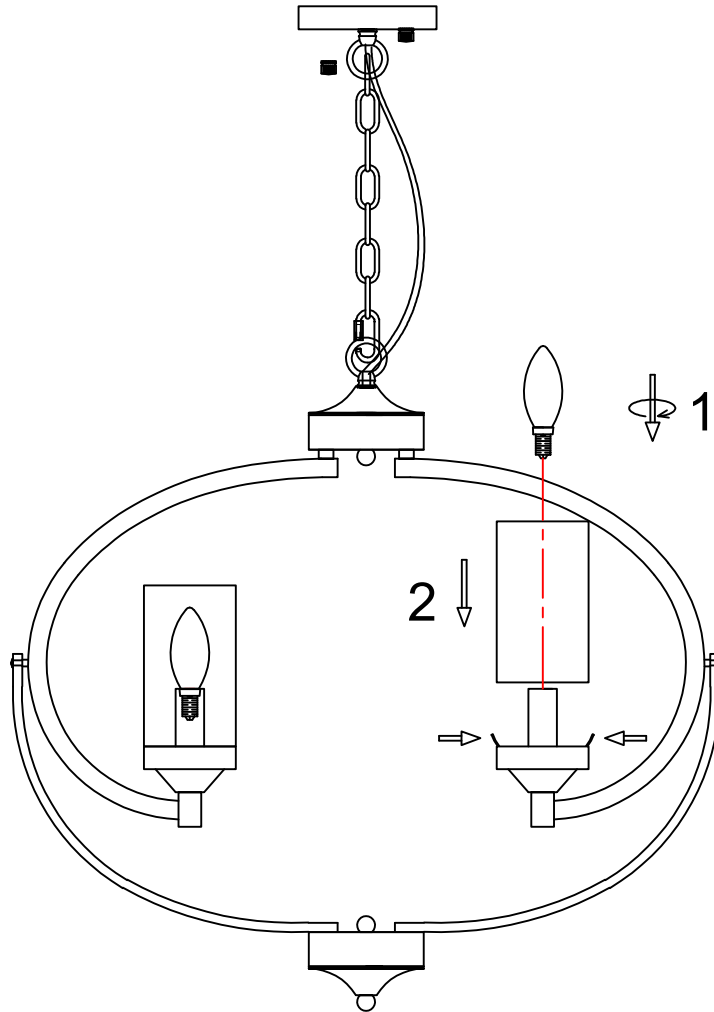

1. Twist the light bulb onto the lamp head.
2. Squeeze the spring tabs on the lamp base inwards first, then fit the glass lampshade

Please read carefully before installation!!!

Note : Please make sure that the electricity is powered off during installation !

Only a professional electrician should install this kind of product !

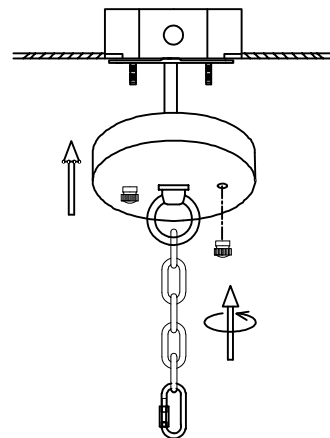
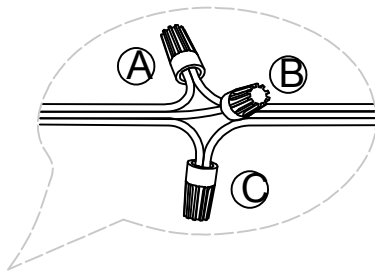
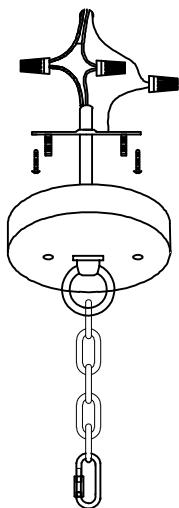
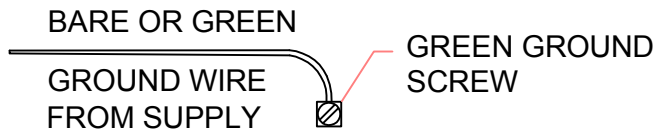
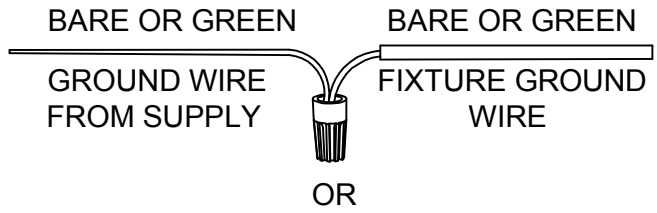
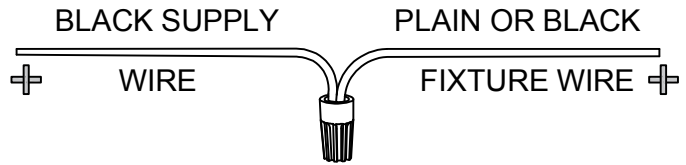
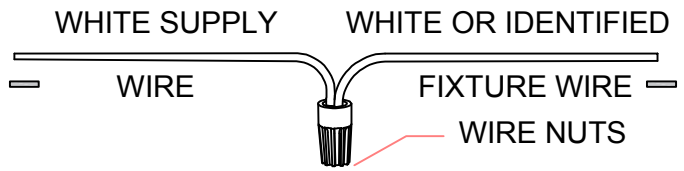
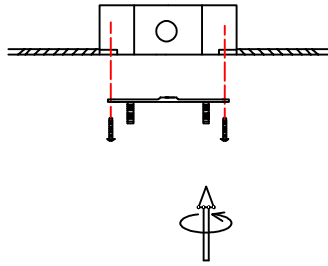

Disclaimer

Read this disclaimer completely and carefully before proceeding with the rest of the manual content.

1. Product Modifications

Any modifications or alterations to this product void any warranties and may result in damage or injury. We shall not be liable for any damages resulting from such modifications or alterations.

2. Compliance with Laws

Customers shall be liable for ensuring that the use of this product complies with all applicable laws and regulations in their respective jurisdictions. We shall not be responsible for any violations of laws or regulations resulting from the use of this product.

3. Correct Use

Always use this product only as directed in the accompanying manuals. Failure to follow instructions may result in injury or damage. Always ensure the assembly, installation, operation, maintenance, or repair of this product is carried out by a competent person. Regular maintenance should be performed throughout the lifecycle of this product. You are responsible for ensuring this product operate as intended. Always wear appropriate protective gear.

4. Third-Party Products

We shall not be liable for any damages or losses resulting from the use of third-party products in conjunction with our products. Customers shall refer to the third-party' sguidelines or/and warranties (if any) for any third-partyproducts used.

5. Limitation of Liability

We shall not be liable for any direct, indirect, punitive, incidental, special, or consequential damages to property or life, whatsoever arising out of or connected with the use or misuse of our products. In no event shall our liability exceed the value of the products sold.

6. Warranty

Refer to the sales page for warranty information.

This disclaimer states the entire obligation of us with respect to this product. If any part of this disclaimer is determined to be void, invalid, unenforceable, or illegal, including but not limited to the warranty disclaimers, liability disclaimers, and liability limitations set forth above, the invalid or unenforceable provision will be deemed superseded by a valid and enforceable provision that most closely matches the intent of the original provision and the remainder of the agreement shall remain in full force and effect.