

ASSEMBLY INSTRUCTION

Thank you for purchasing the quality product. Be sure to check all packing material carefully for small parts which may have come loose inside the carton during shipment. Separate, identify and count all parts and metal hardware. Compare with all parts list to be sure all parts are present. If any part(s) are missing or damaged, please contact your local furniture dealer. For efficient and speedy service, please indicate the model number and code letter of part(s) needed.

*****Do not fully tighten screws until fully assembled*****

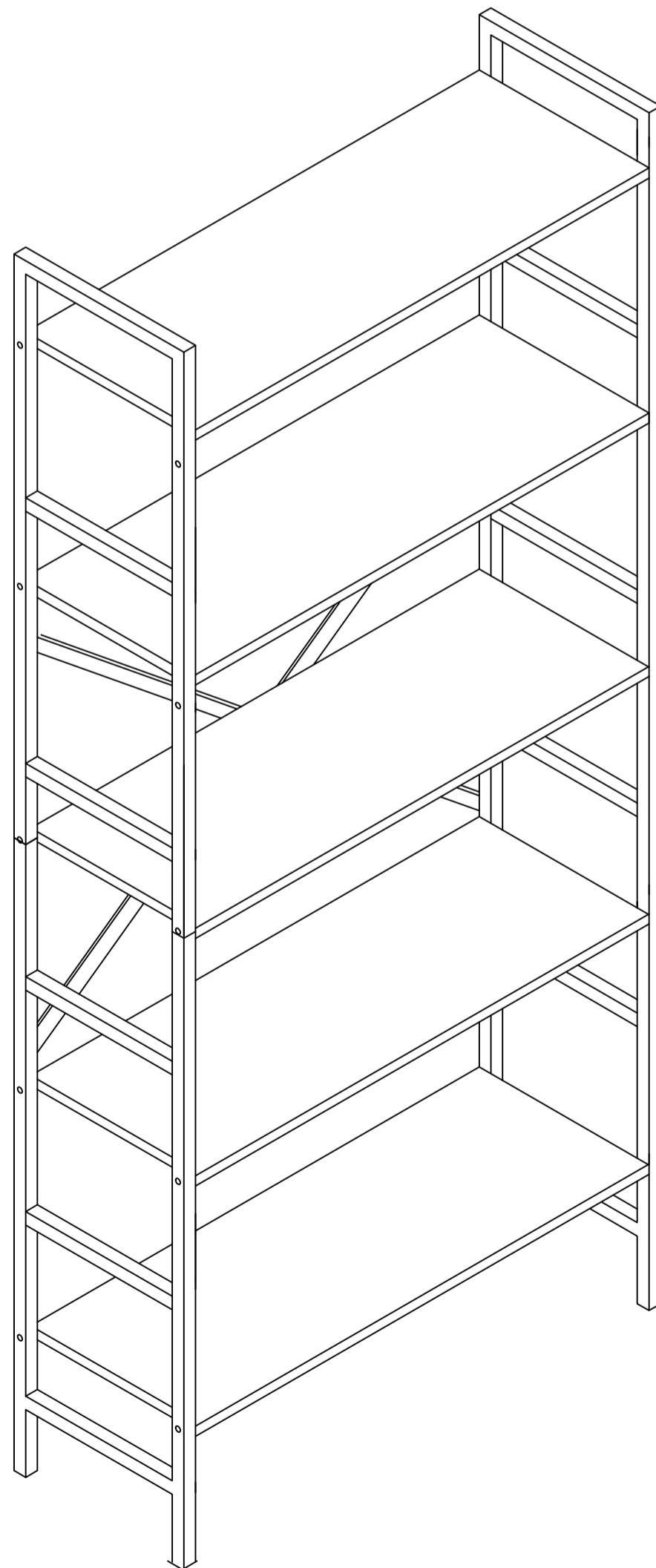

Attention:

*****Some number parts listed on the instruction sheet may not be in parts bag as they may already be assembled. Carefully check parts and packing materials prior to ordering replacements.**





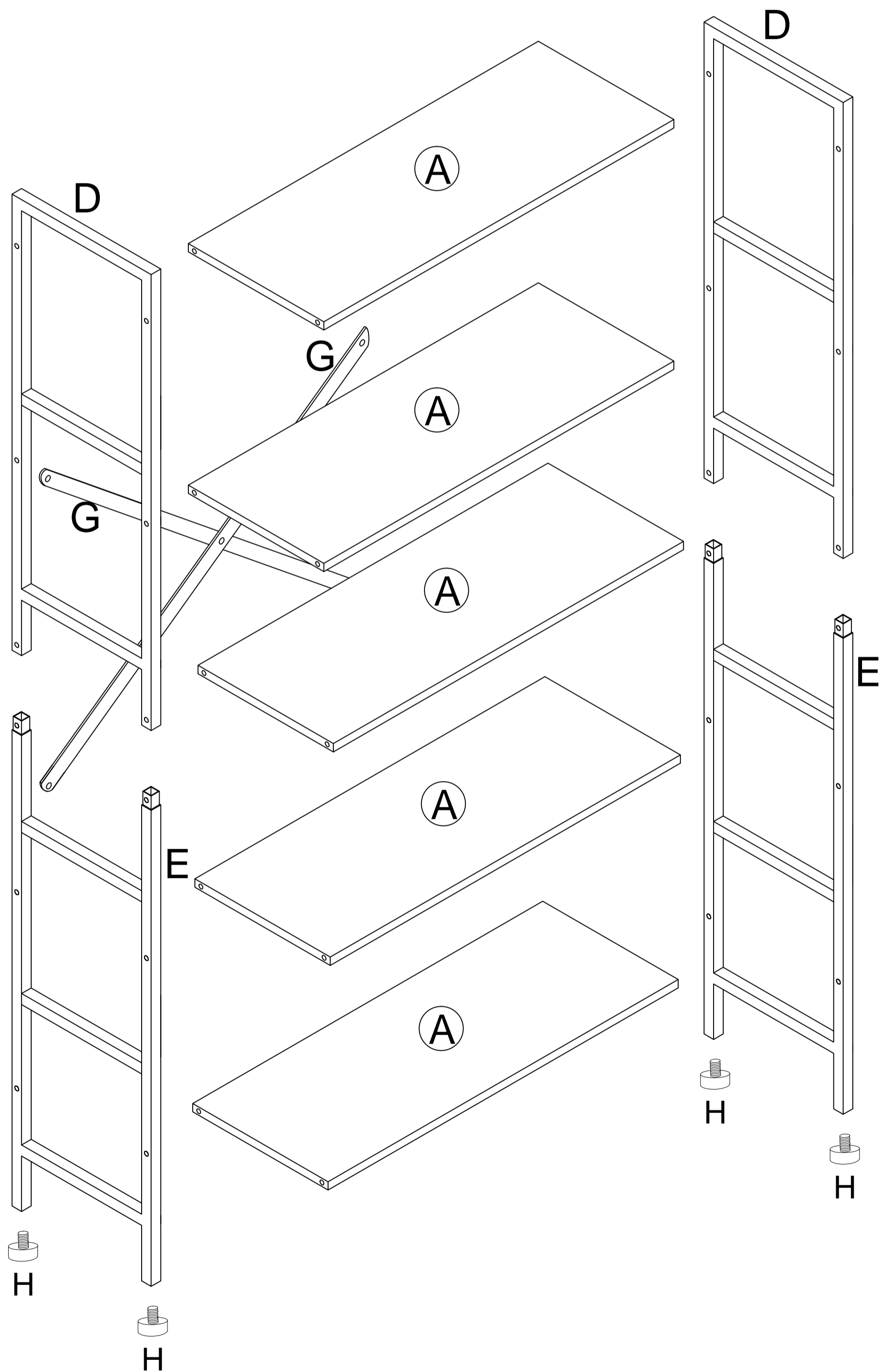

General Assembly Guidelines

- I. Ensure that all parts and hardware are available before beginning assembly.
- II. Follow each step carefully to ensure the proper assembly of this product.
- III. Two people are recommended for ease in the assembly of this product.
- IV. The three main types of hardware used to assemble this product are: wood dowels, screws and bolts.

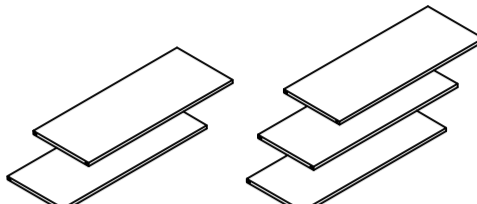
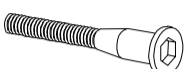
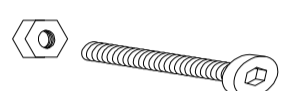
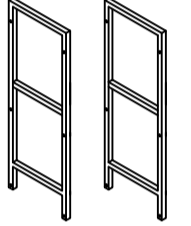
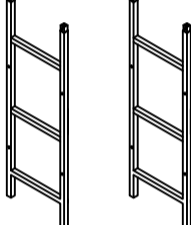
COMPONENT PARTS

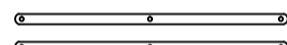

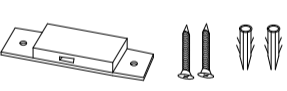
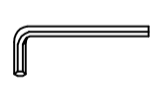
COMPONENT PARTS

A		570*300*15MM Artificial plate	5	pcs
B		Ø5x40mm Long hexagon screws	21	pcs
C		M6*30 mm Back fork screw	4	pcs
D		Above the iron frame	2	pcs
E		Below the iron frame	2	pcs
F		M6*10 mm Back fork center screw	1	pcs
G		Back bracket strip	2	pcs
H		Leveling feet	4	pcs
I		Anti-falling device	2	pcs
J		3mm hexagon spanner	1	pcs
K		open spanner	1	pcs
L		4mm hexagon spanner	1	pcs

Step 1

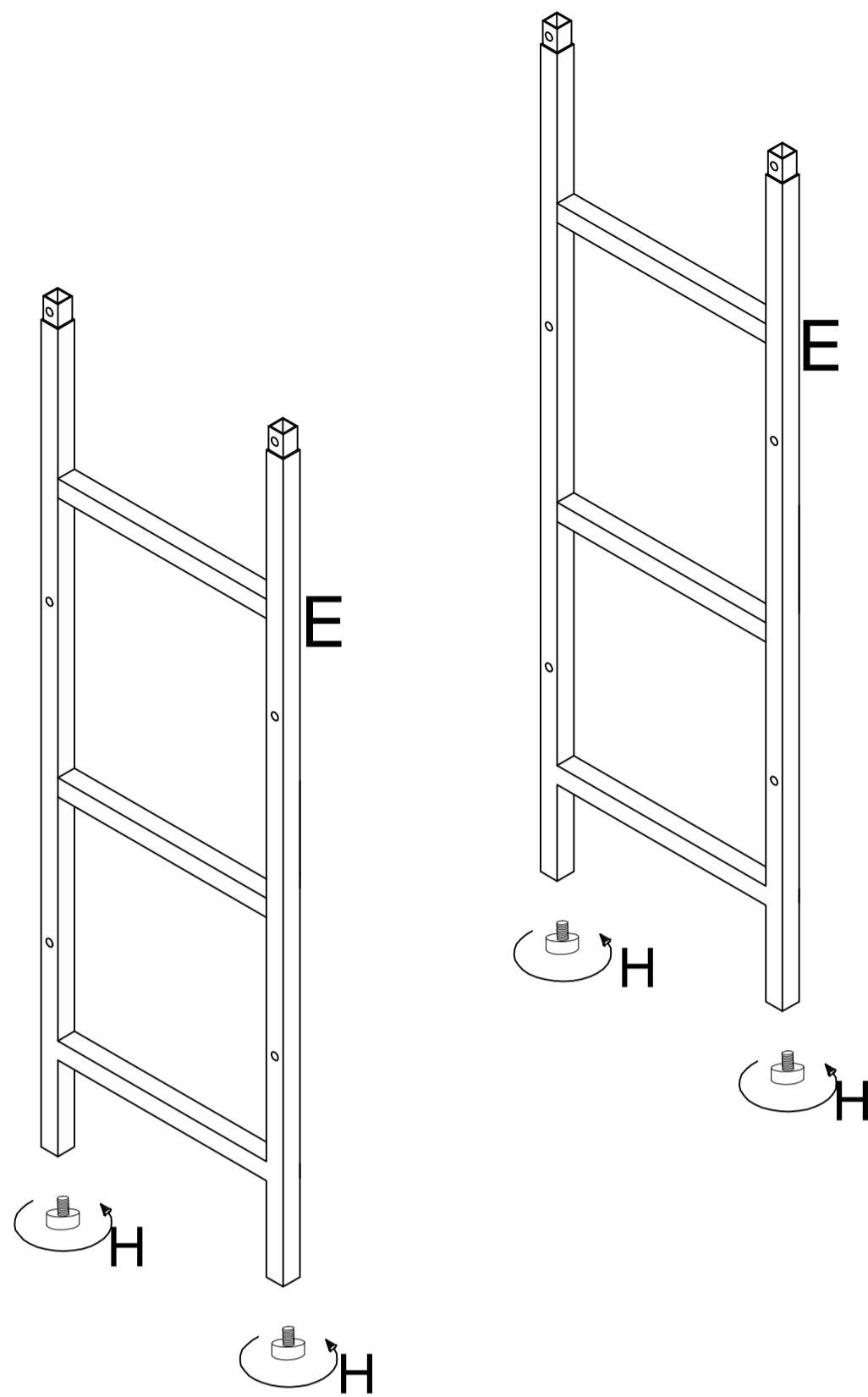
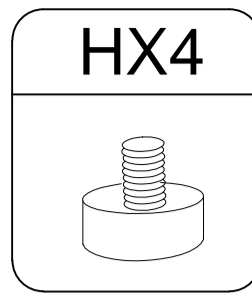
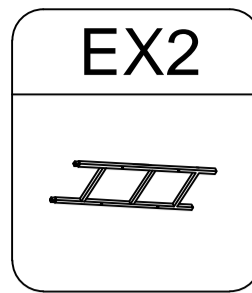

Step 2

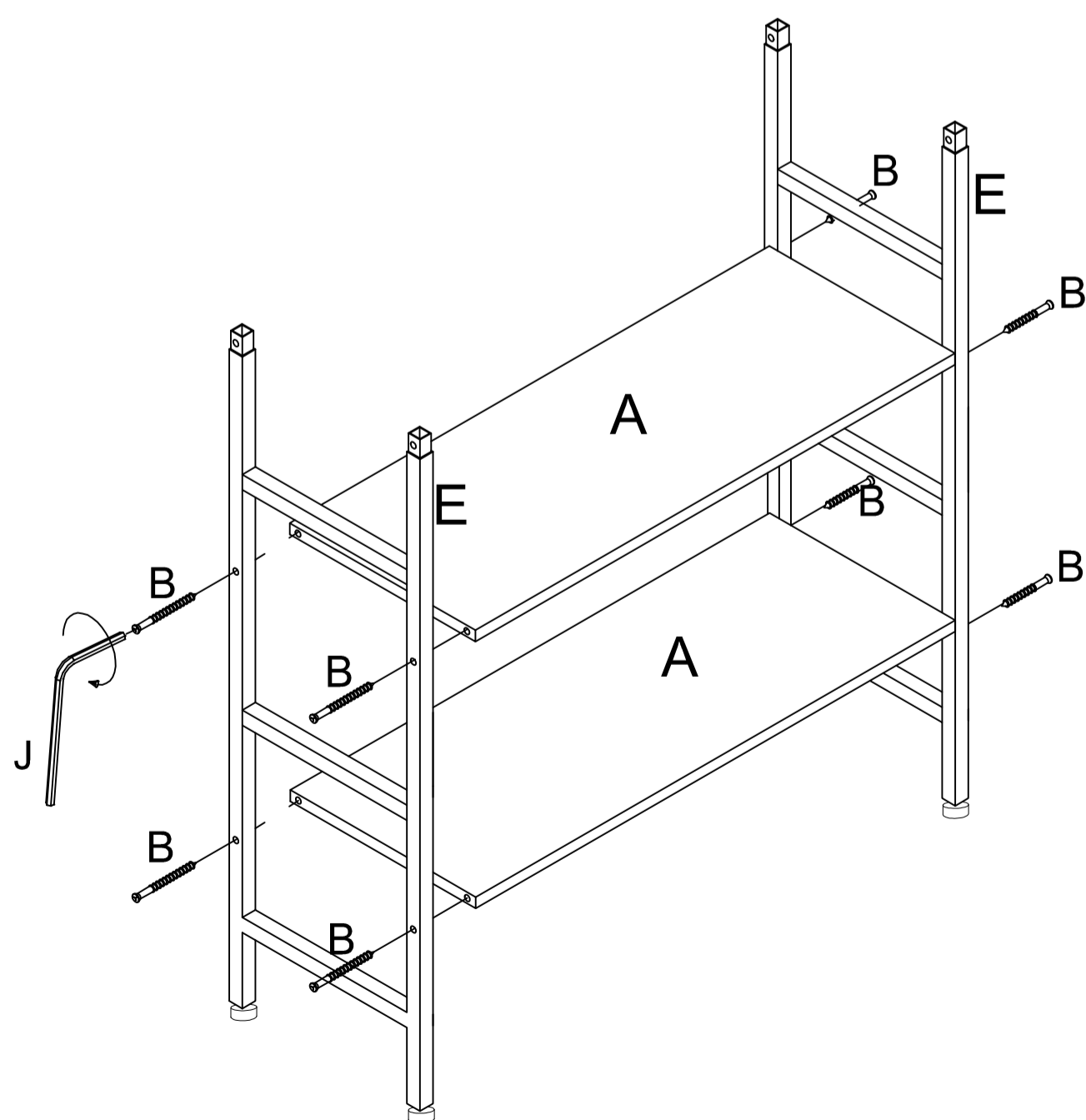
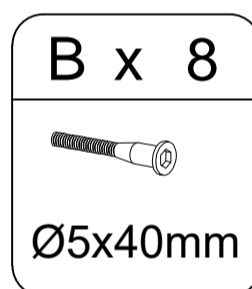
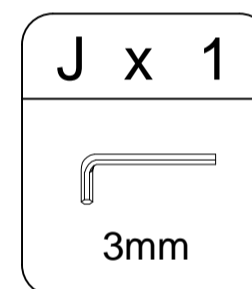
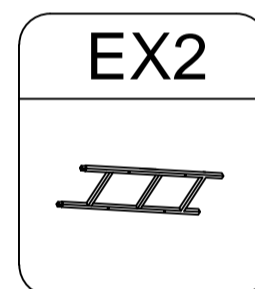
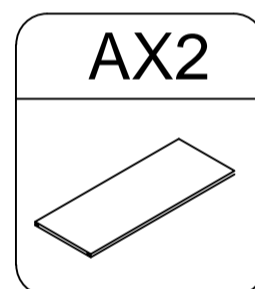

Step 3

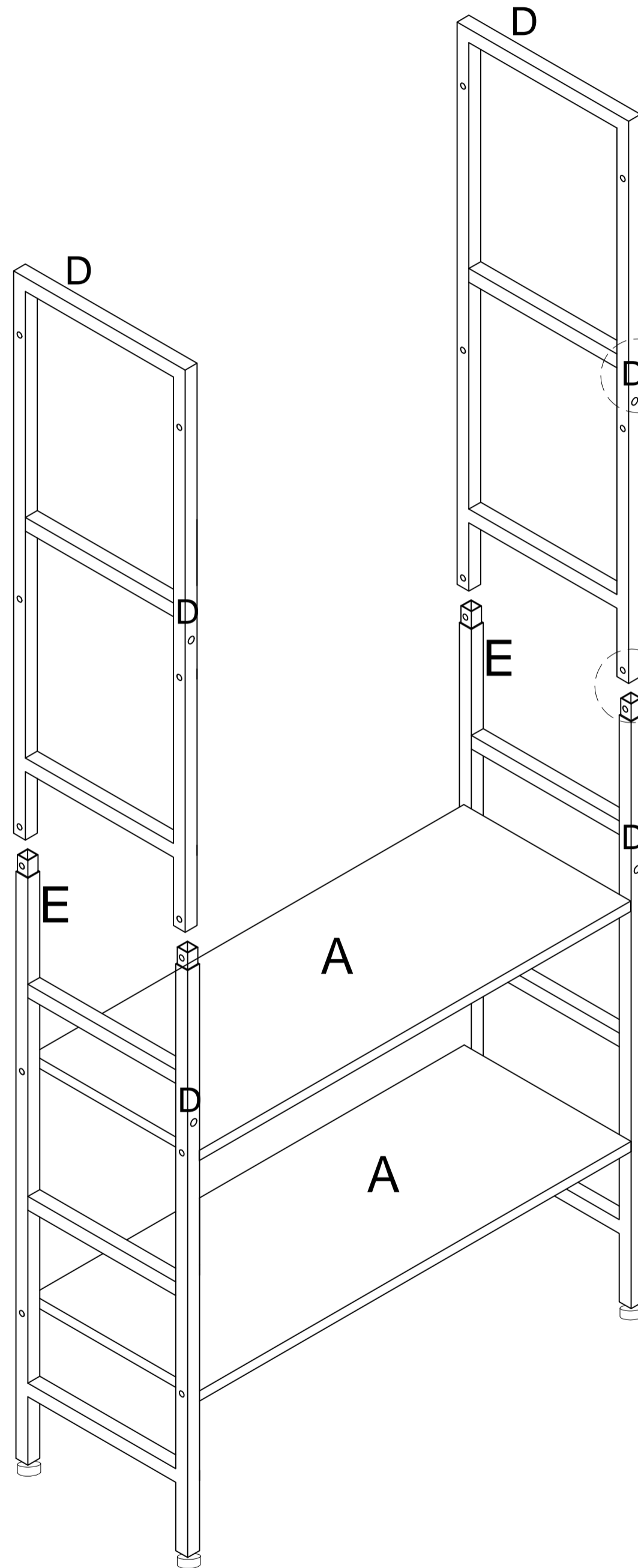
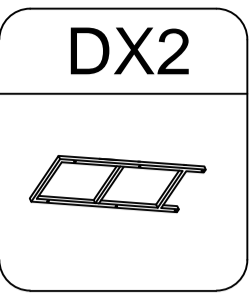

Tips: Please put the label (D) on the same side, which is used to install the back fork

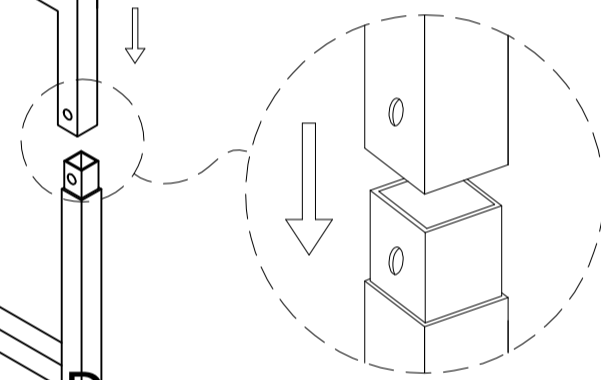

Step 4

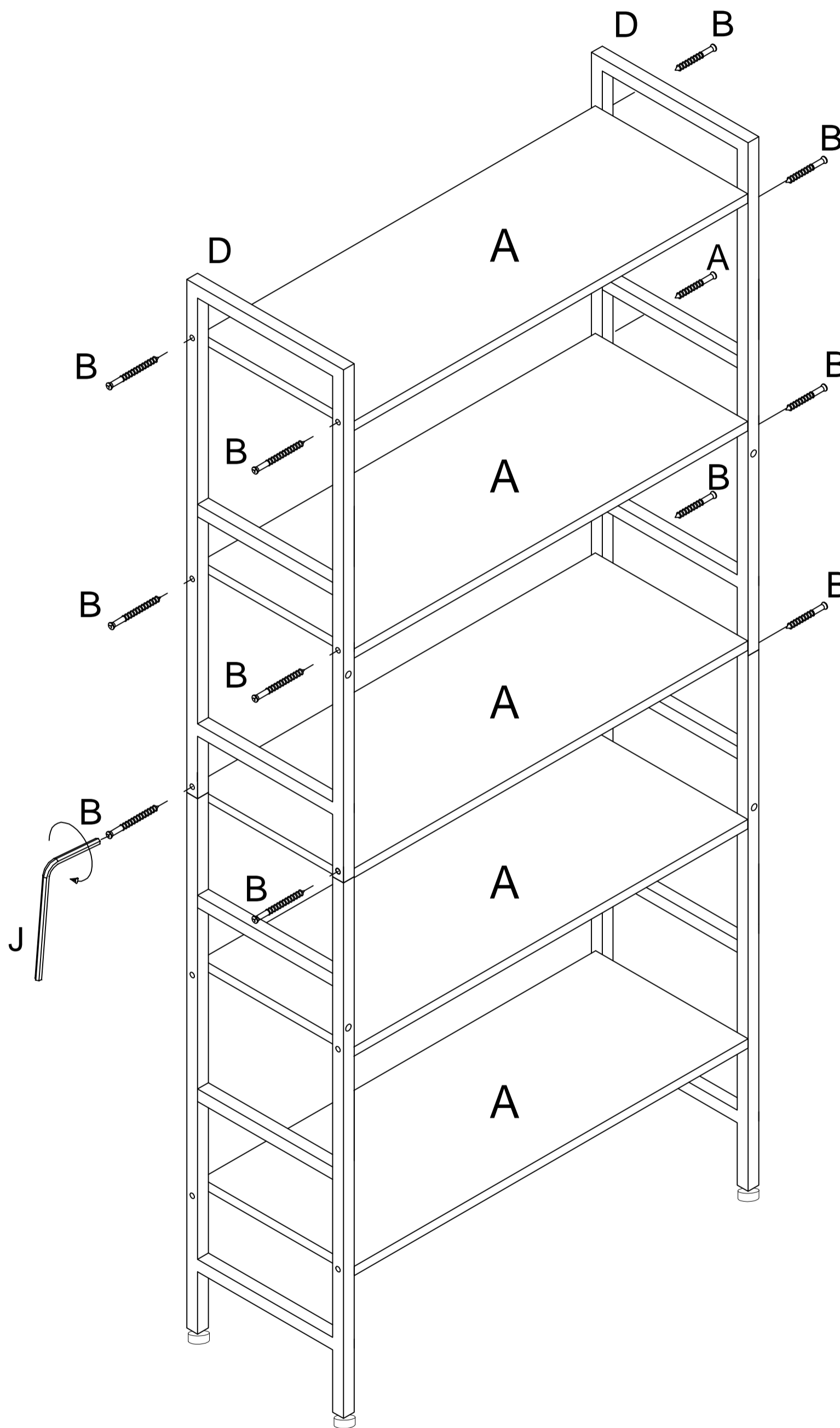
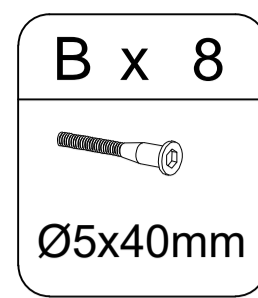
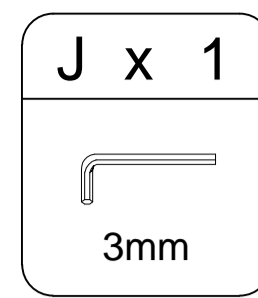
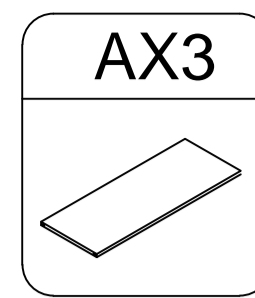

Step 5

K x 1



Wrench icon

L x 1

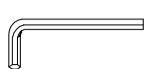

4mm

C x 4



M6*30 mm

F x 1



M6*10 mm

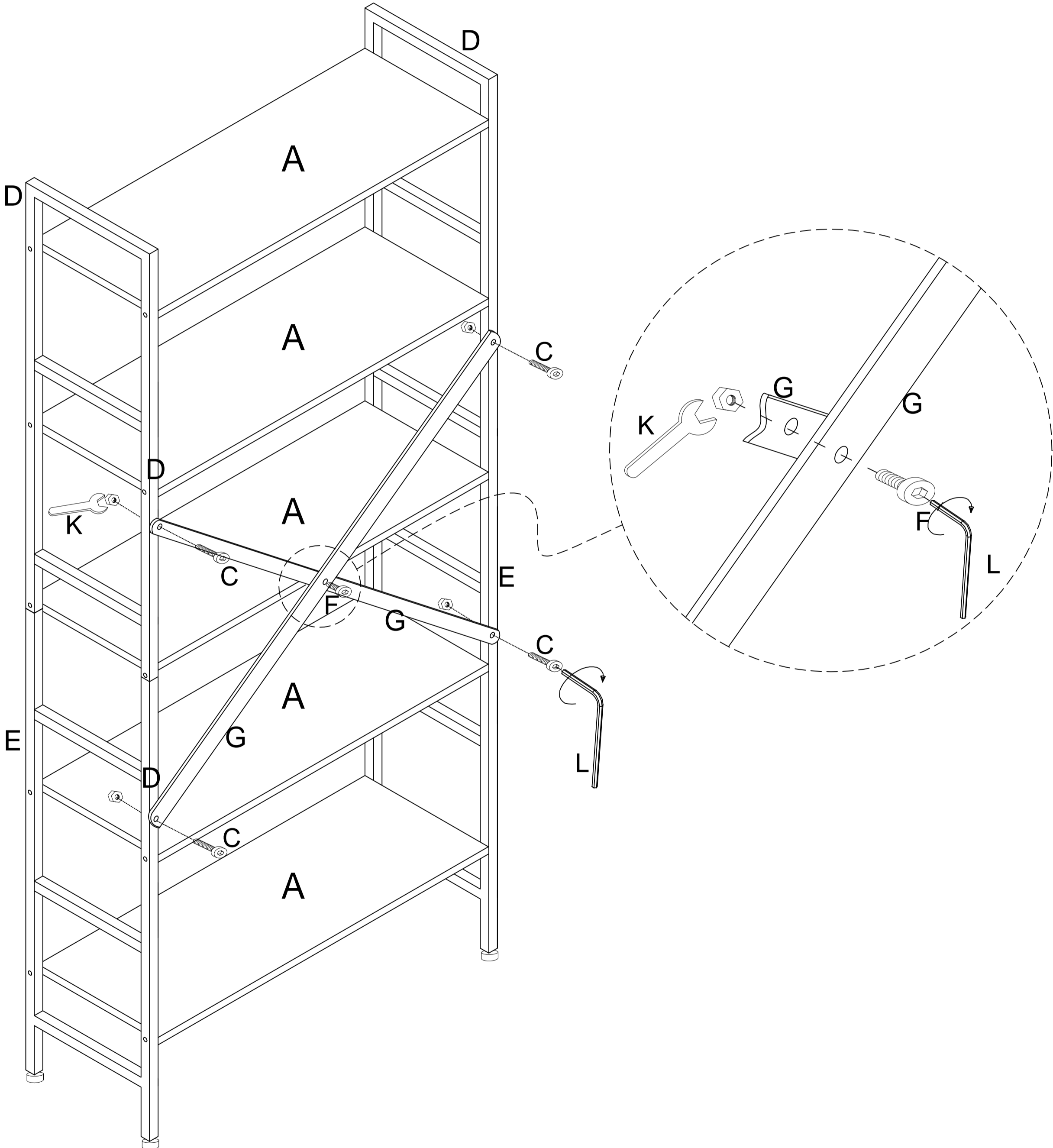

Step 6

