

# Brand Introduction

*LED Bathroom Mirrors, Make Life Polychrome*

*We strive to deliver real value for our customers through distinctive design, superb quality and excellent customer service at prices that reflect the real worth of our products.*

*Anti-fogging/Dimmable Light/Memory Function/3 Year Warranty  
Perfect choice for your bathroom, bedroom and makeup room.*



- ▶ We strictly implement quality control to ensure that the products are 100% safe and qualified. If there is any problem when you receive the mirror, please feel free to contact us by email.
- ▶ If you are satisfied with the mirror, welcome to share it on social media. We look forward to your comments and video feedback as well as your suggestions for us.

## Warm Note

- 1.If you have any confused questions about the mirror,you can e-mail us and we are willing to help you solve problem.
- 2.If you find the electronic component damaged,please contact us and we'll resend to you.



**Wiring must be installed by qualified electricians**

- ▶ If you have any suggestions or advice, please feel free to send e-mail to our customer services.

## Q & A

*After receiving the mirror, if you have any problem, please contact customer service at the first time. We will solve the problem for you within 48 hours and you have the chance to win a small prize*

Q1: What if the mirror broken after you receive the package?

A: Please don't worry about it. Take a photo and contact our customer service, we will handle it within 48 hours for you.

Q4: If the inner light strap of the bathroom mirror comes off?

A: Please don't worry about it, please contact our customer service, we will quickly help you to solve such problems.

Q2: The defog function does not work, how to do?

- A:
1. Check whether the switch is turn on (white means turn on)
  - 2.The defog function need to be turned on after 5 minutes to work, please be patient.
  3. If it still can't work, please contact our customer service.

Q5: The bathroom mirror doesn't work after wiring, how to do?

A: Please make sure the null line of wire connection is correct.

Q6: Bathroom cracks on the back of the mirror, what can you do?

A: Please contact our customer service, we will send a waterproof repair subsidy to you.

Q3: The bathroom mirror button does not work?



- A:
1. Open the bathroom mirror back cover, check whether the switch is shifted, if switch shift, just restore the position.
  2. If it's a bad connection, please rewiring.

Q7: How to daily maintenance of the bathroom mirror?

A: You can use the dust cloth and wipe it with warm water.

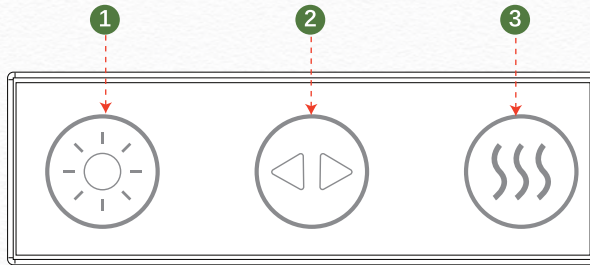
## Product Introduction



- 1  On/Off Switch - Short press the button for On/Off / long press to adjust brightness
- 2  Light Switch Button: Press the middle button to adjust to different lighting, white light/ neutral light/ warm light.
- 3  Anti-fog Button - Press the button for anti-fog function

## Detailed Instruction of Functions

### *Description of Heated Auto-defog Functions*



Short press the button for On/Off the light  
Long press to adjust light brightness

\* For the on-off key, white for on state,  
yellow for off state

## *Light Change Button -adjust different lights*



Short press the button to adjust from white/ warm white/ warm lighting color

\* You need to turn the on-off key on to switch the color temperature

## *Description of Heated Auto-defog Functions*



*Touch to open mirror defogging function*

Mirror defogging constant temperature: 38 °C-45 °C

\*The defogging function can also be used without turning on the light

*Memory Function*

\* The mirror features memory function, the next time you turn the light on, the lighting color will be the same as the last one.

## Product Installation

# 06

### Recommend Height

1. When installing the bathroom mirror, please first pick up the bathroom mirror and confirm the best installation height for marking, then punch for installation
2. Make sure your face is in the middle of the mirror for a better image.



# Wiring Method

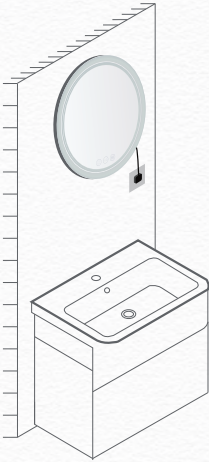

## Method 1

Extend the line of the bathroom mirror from the grooves on the side and plug it in to use.

**To reduce the risk of strangulation, the flexible cable connected to this luminaire must be fixed on the wall when the cable is in the hand region**

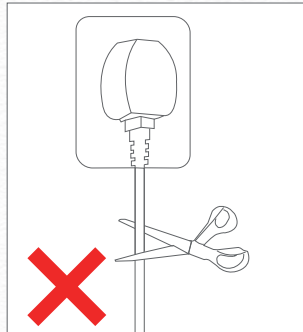
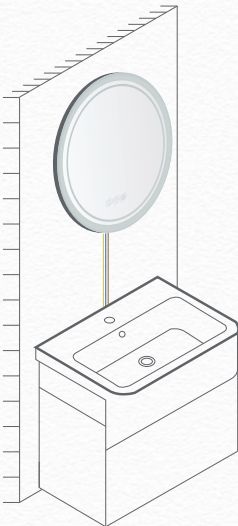
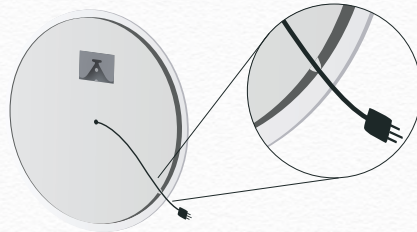

## Method 2

1. Wiring must be installed by qualified electricians
2. Please use insulating tape to protect the wires

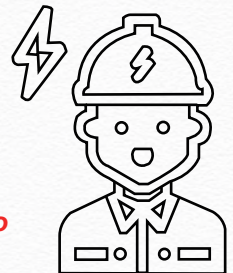

	AU	US	EU	UK	TP	JP
L					Don't need to distinguish the wiring colors	
N						
E						

# Square Bathroom Mirror(Vertically/Horizontally)



Tape Measure



Pencil



Drill



Hammer



Screwdriver



Screw Kit (Set)

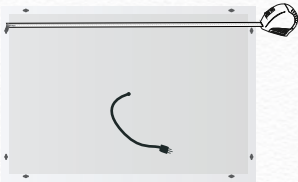

1. Measure the distance of the bathroom mirror hook.

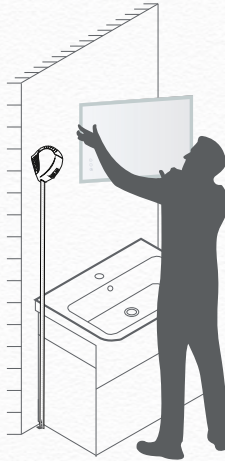

2. Lift the bathroom mirror up to confirm the best mounting height

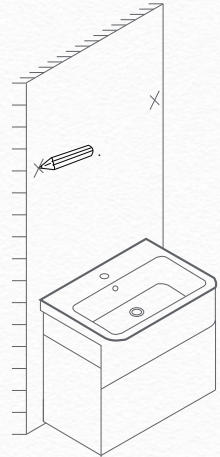

3. Mark the wall with a pencil

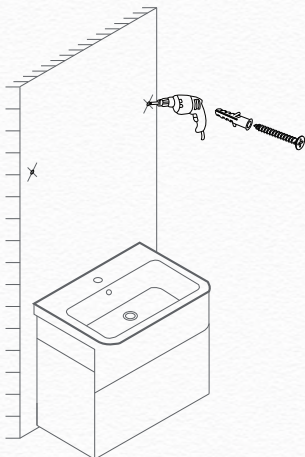

4. Drill the marks with an electric drill. Drive a screw and an expansion plug into the hole.

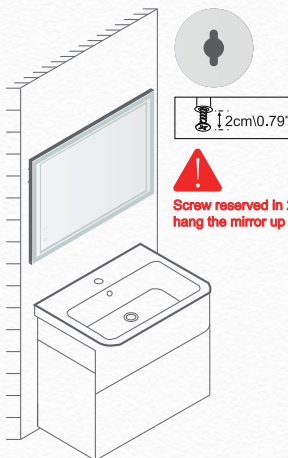

5. Hang up the bathroom mirror.

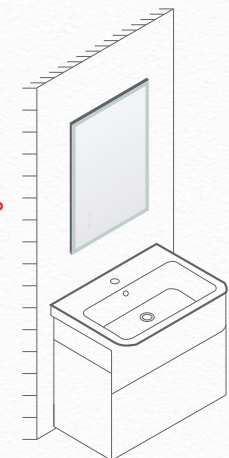

You can hang it vertically in the same way