

File Cabinet
Instruction Manual
Mueble archivador
Manual de instrucciones
Classeur
Manuel d'instructions

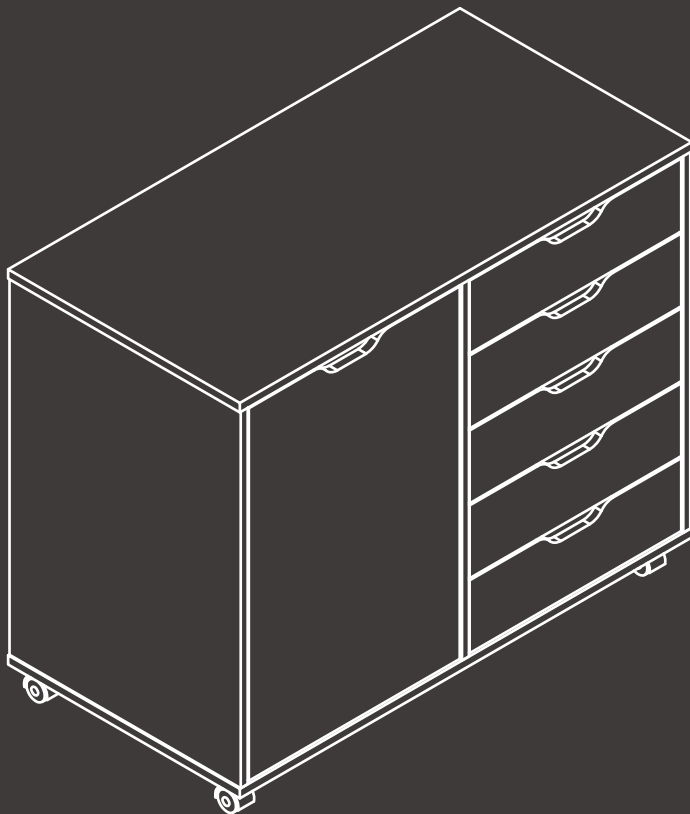

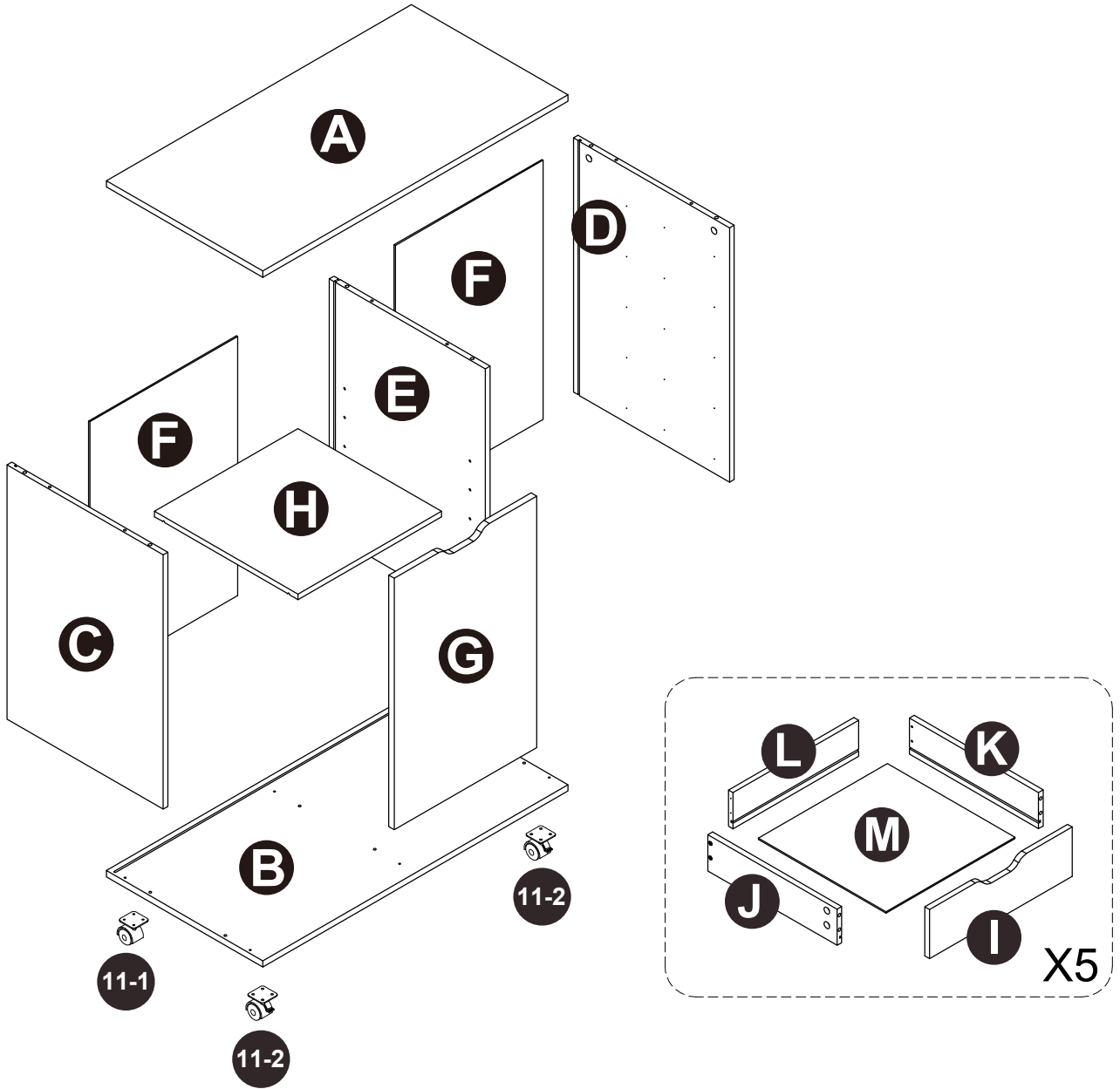

A X1

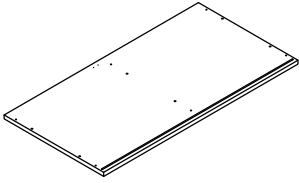

B X1

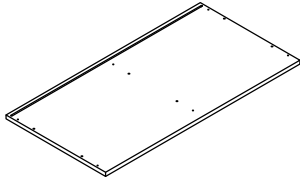

C X1

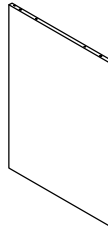

D X1

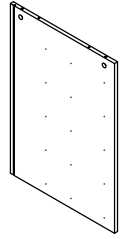

E X1

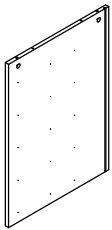

F X2

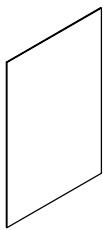

G X1

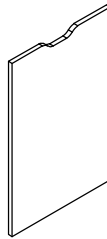

H X1

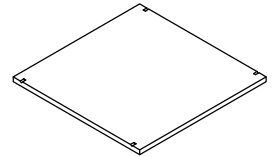

I X5

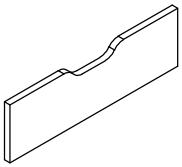

J X5

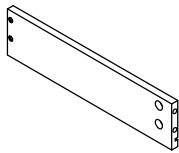

K X5

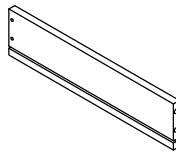

L X5

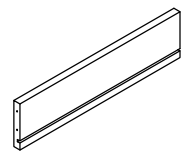

M X5

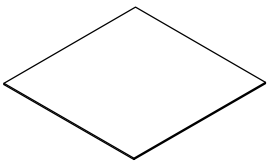

1 X26+1

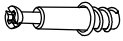

Φ6x34mm

2 X26+1



Φ15x9.5mm

3 X12+1



Φ6x30mm

4 X26+1

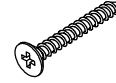

Φ4*30mm

5 X4



6 X80+2



Φ3.5x12mm

7 X12



EN: Nickel color
ES: Color níquel
FR: Couleur nickel
Φ3.5x12mm

8 X12

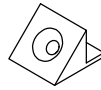

9 X5

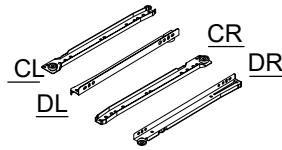

L300mm

10 X2

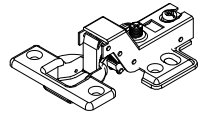

11 X2

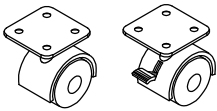

11-1

11-2

12 X1

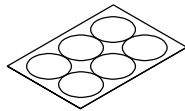

13 X1

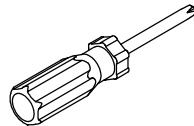

14 X1

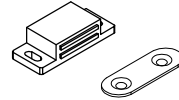

14-1





14-2

15 X2



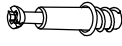

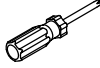

Φ3.5x15mm

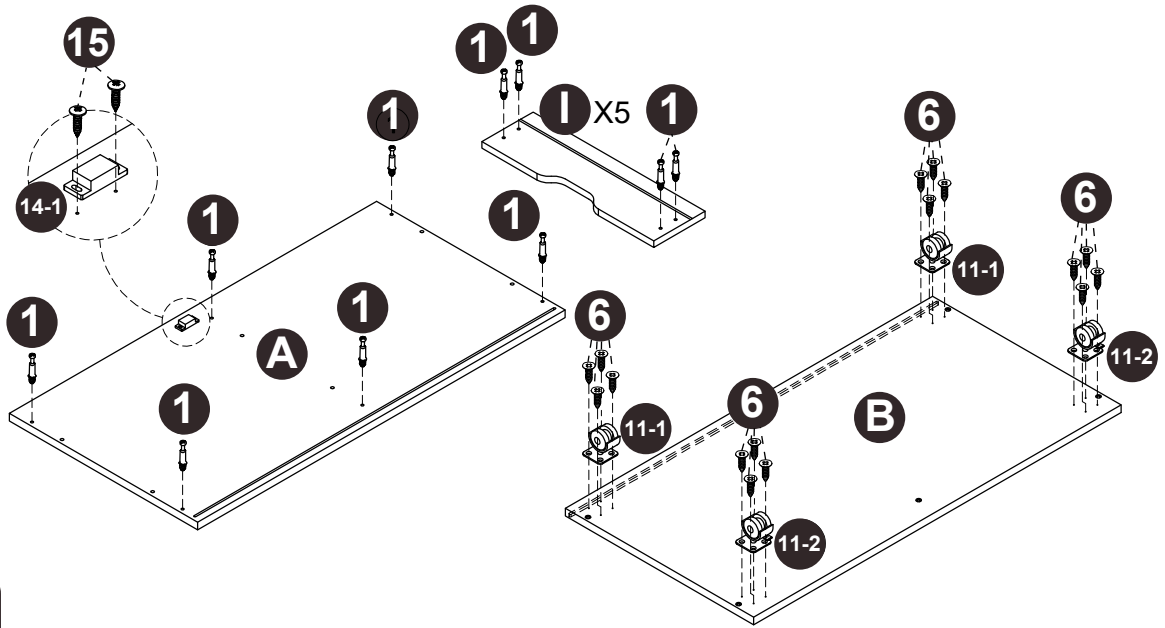
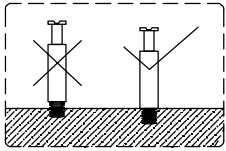
Step 1

 1 x26	 6 x16	 11 x2	 13 x1	 14 x1	 15 x2
---	---	---	--	---	---



Step 2

 6 x30	 9 x5 <u>CR</u>	 9 x5 <u>CL</u>	 13 x1
---	---	--	---

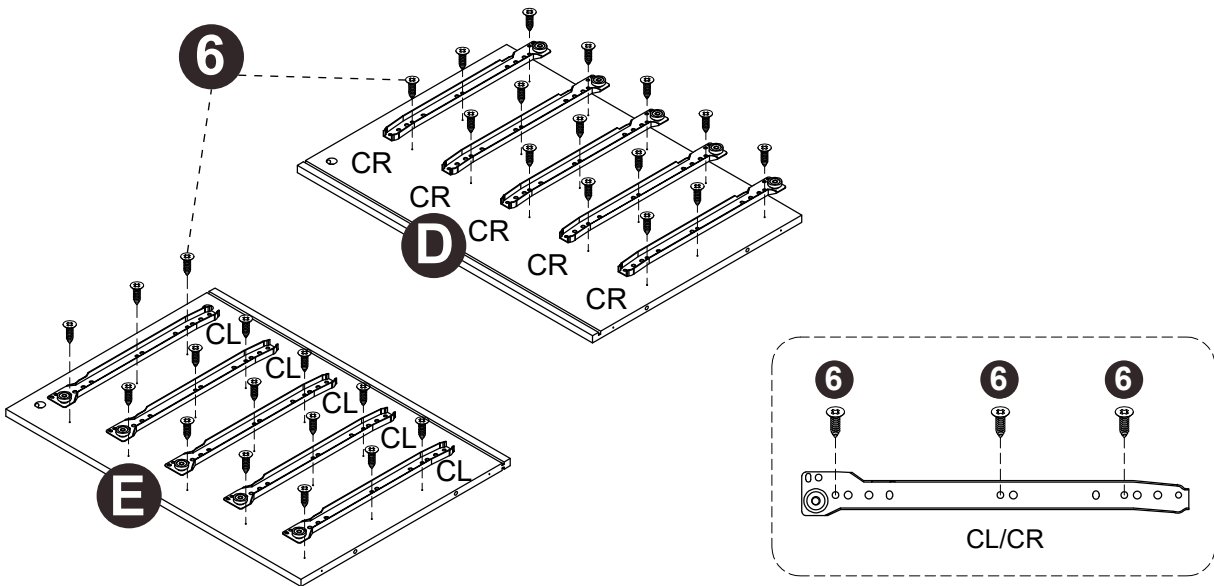

Step 3

 3 x6	 4 x6	 13 x1
---	--	---

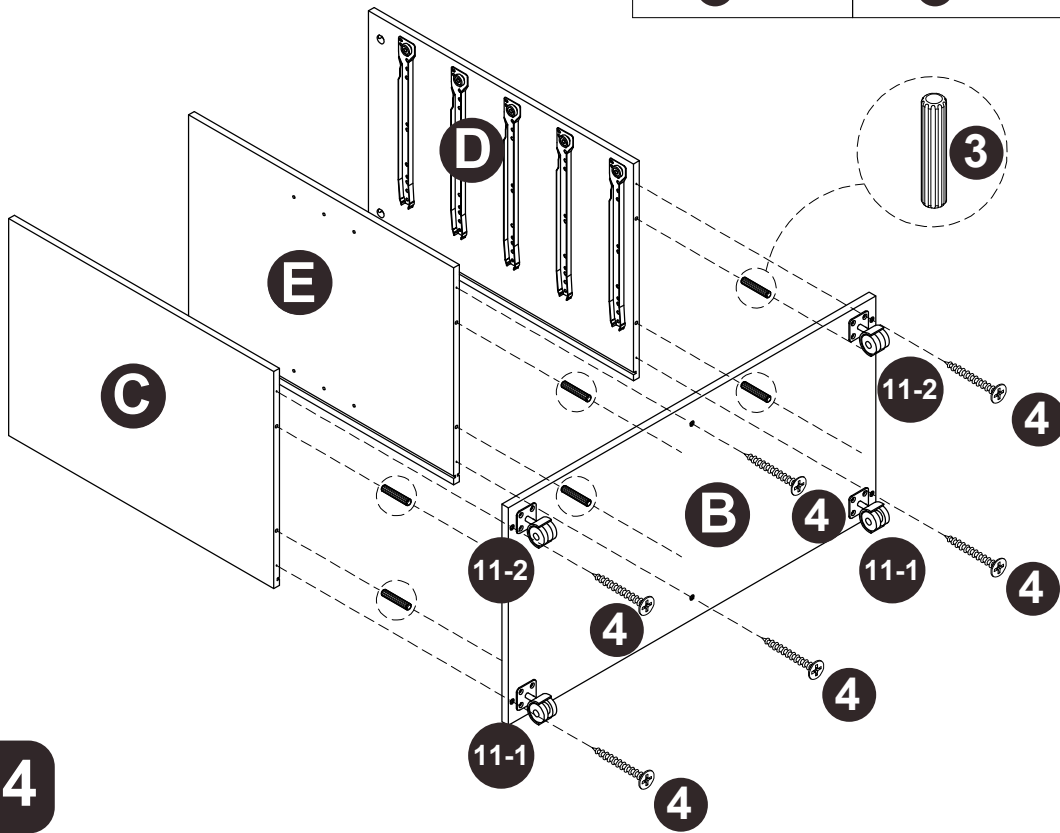

Step 4

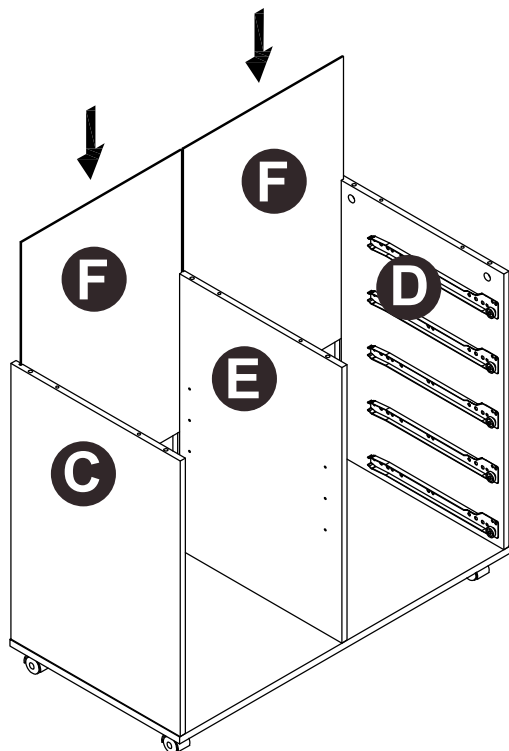

Step 5

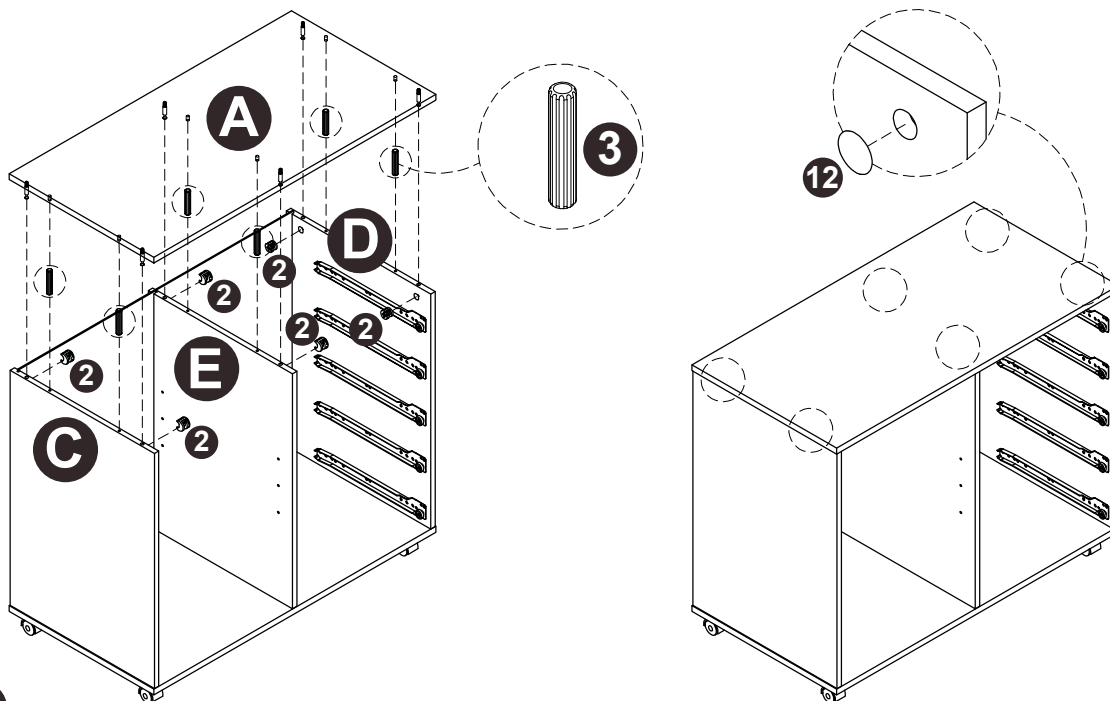
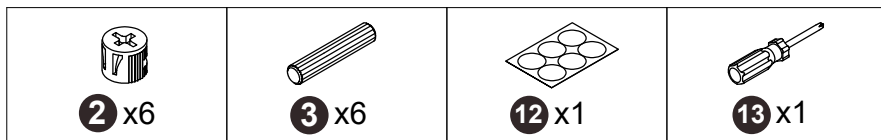
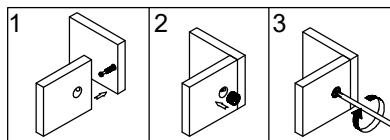

Step 6

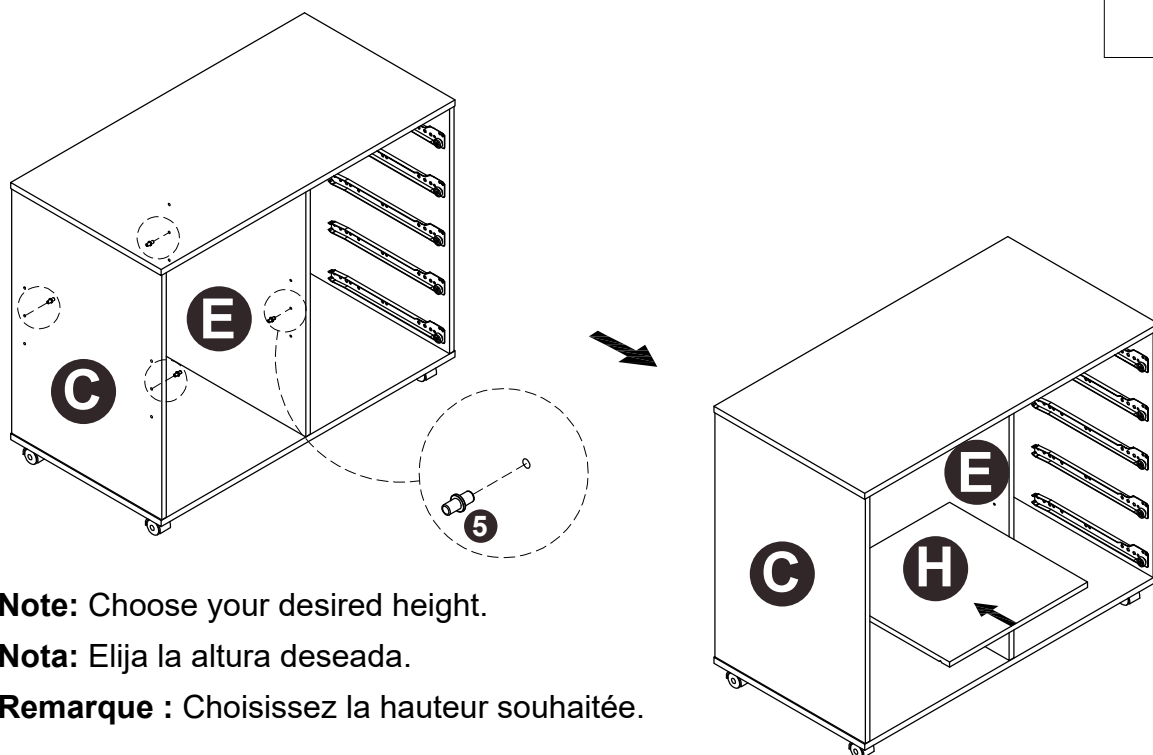
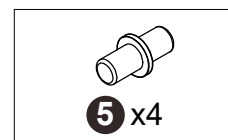





EN: **Note:** Choose your desired height.

ES: **Nota:** Elija la altura deseada.

FR: **Remarque :** Choisissez la hauteur souhaitée.

Step 7

 6 x2	Nickel Color/Color níquel/Couleur nickel  7 x4	 10 x2	 13 x1	 14-2 x1
--	--	--	---	---

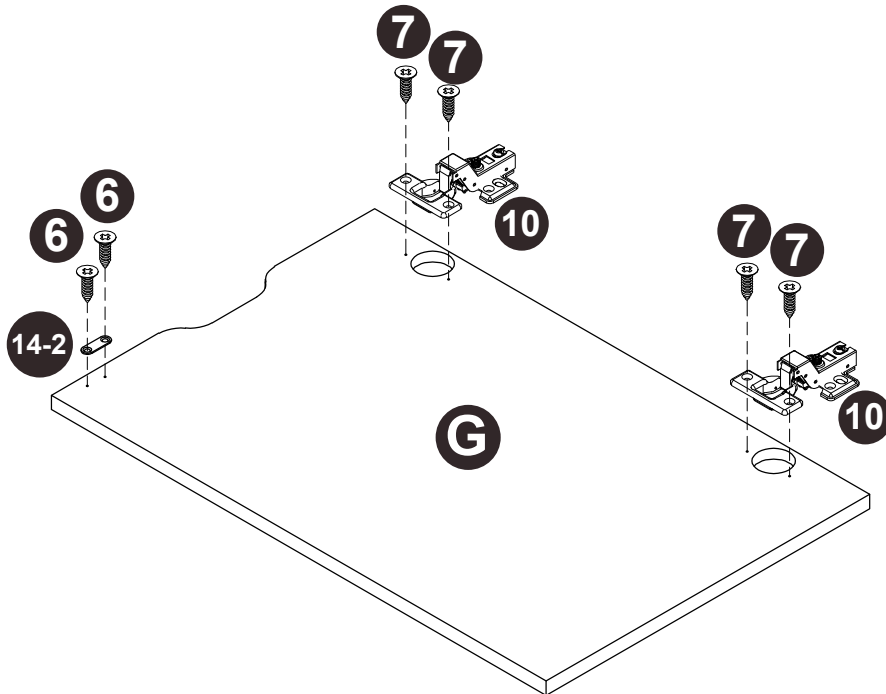

Step 8

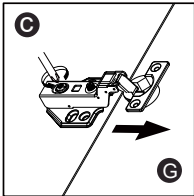

EN: Use the outer screw to adjust the length of the overlap between board **C** & **G**.

ES: Utilice el tornillo exterior para ajustar la longitud del solape entre los paneles **C** y **G**.

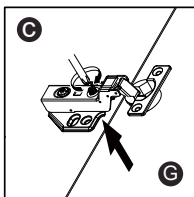

FR: Utilisez la vis extérieure pour ajuster la longueur du chevauchement entre les panneaux **C** et **G**.



EN: Use the inner screw to adjust the gap between board **C** & **G**.

ES: Utilice el tornillo interior para ajustar la separación entre los paneles **C** y **G**.

FR: Utilisez la vis intérieure pour ajuster l'écart entre les panneaux **C** et **G**.

Nickel Color/Color níquel/Couleur nickel  7 x8	 13 x1
--	---

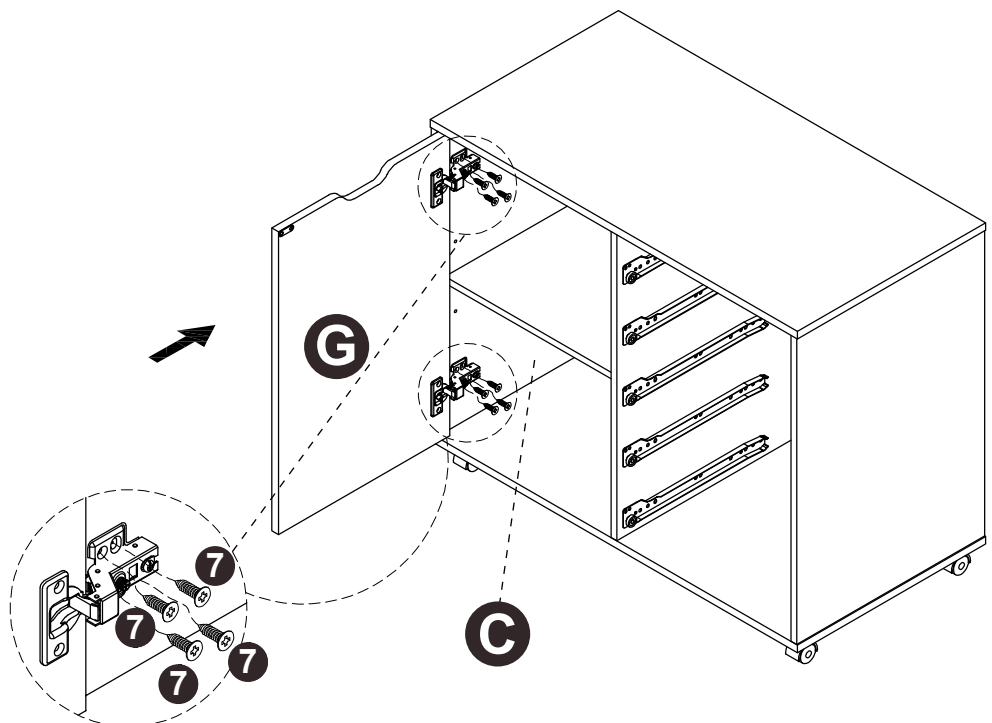

Step 9

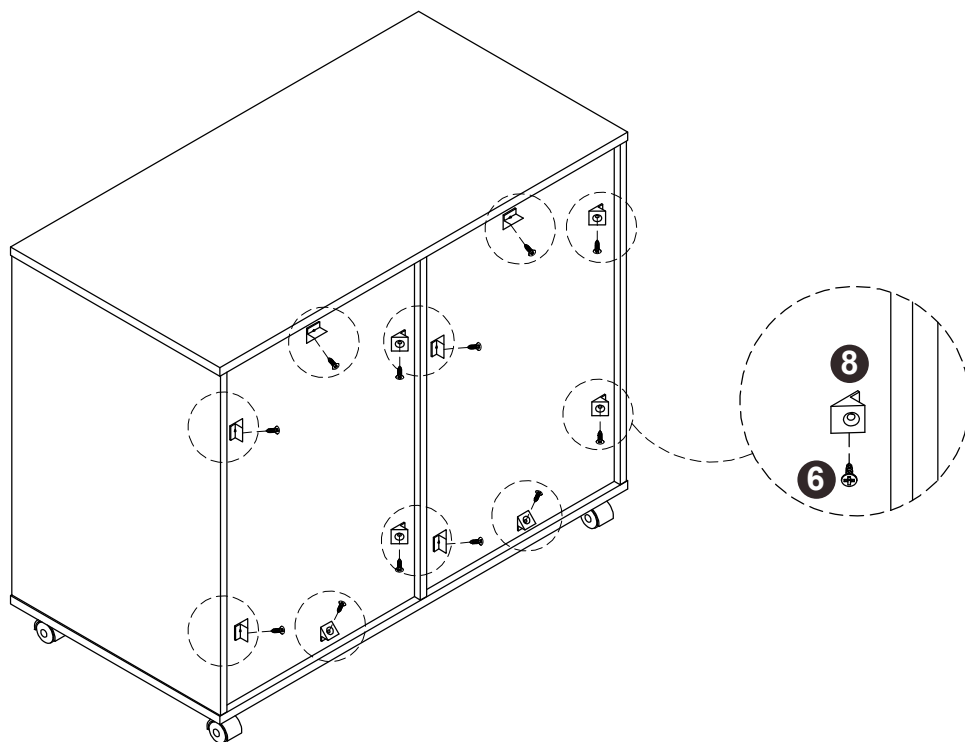
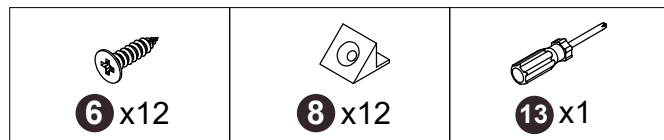

Step 10

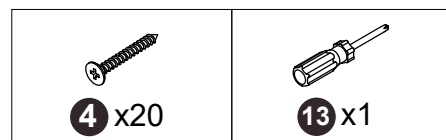

X5

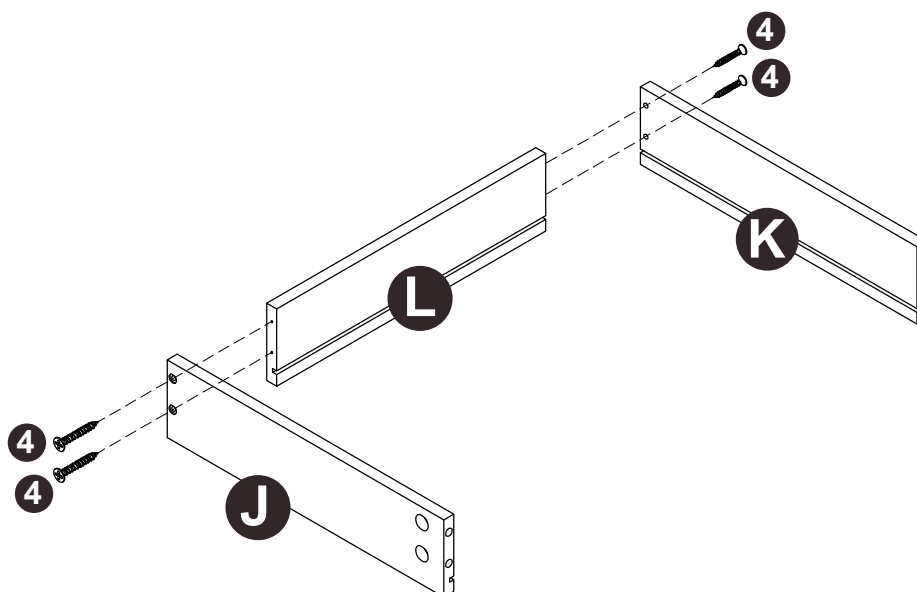

Step 11

X5

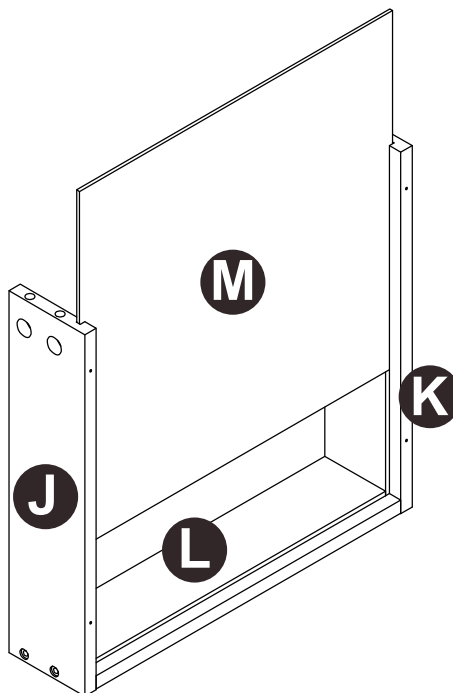

Step 12

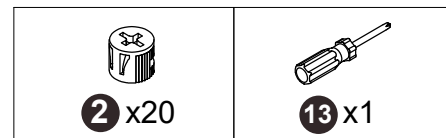
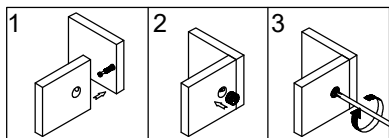

X5

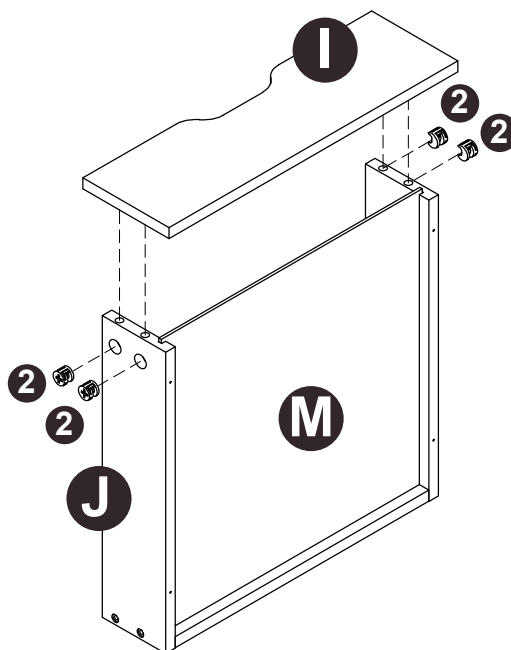

Step 13

EN: **NOTE:** Turn the drawer over.

ES: **NOTA:** Dé la vuelta al cajón.

FR: **REMARQUE :** Retournez le tiroir.

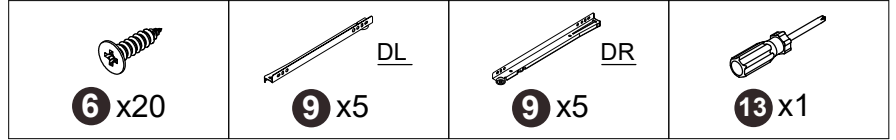

X5

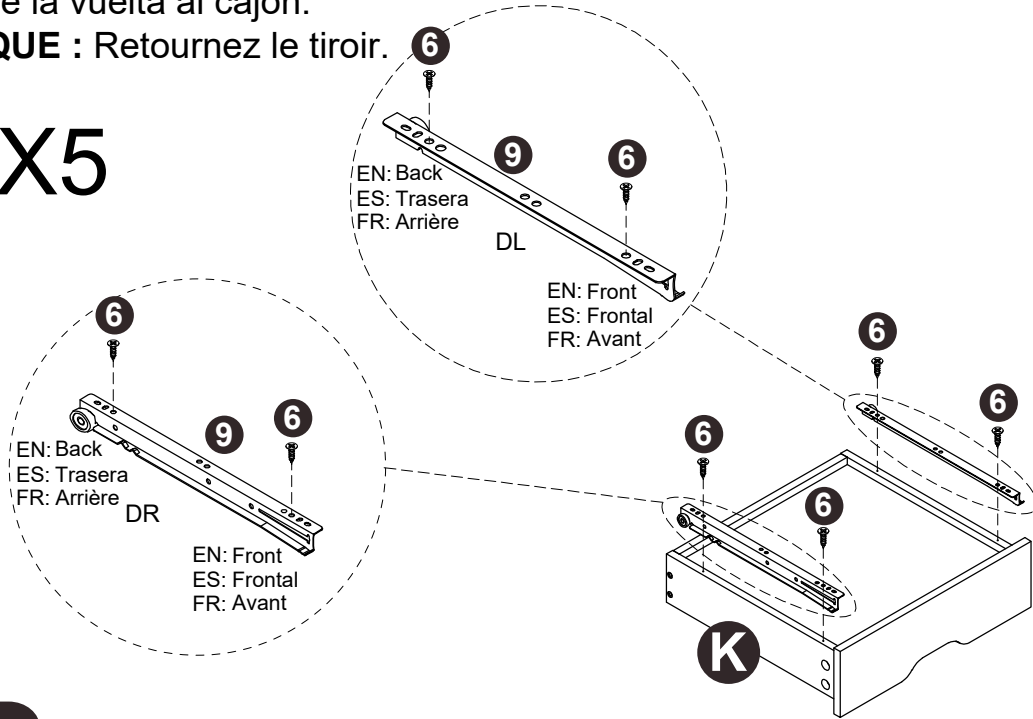

Step 14

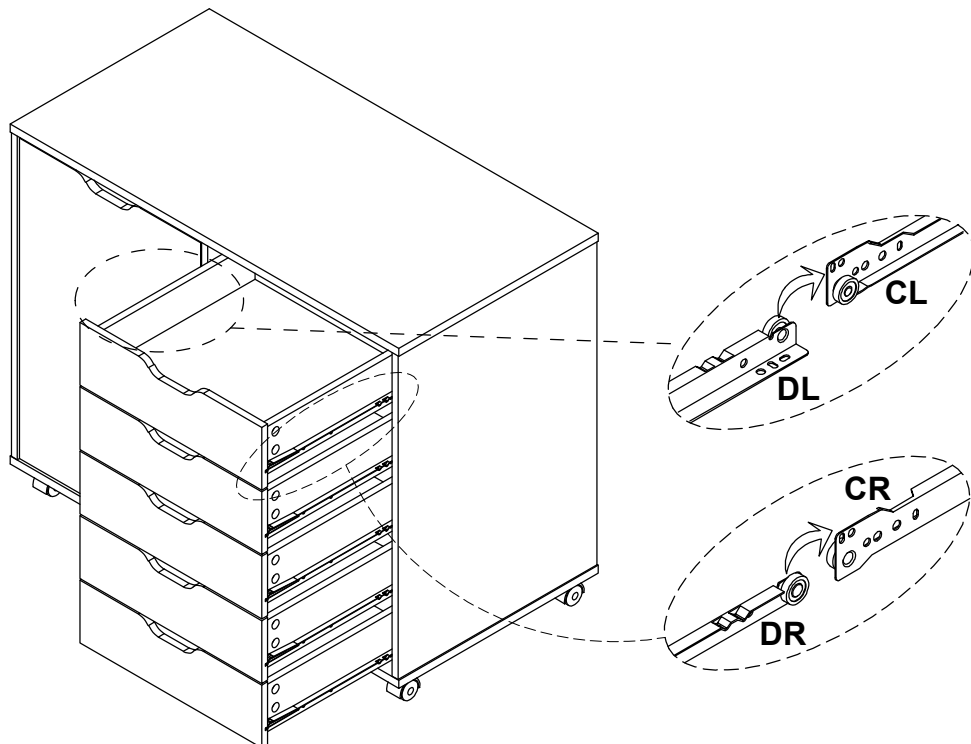

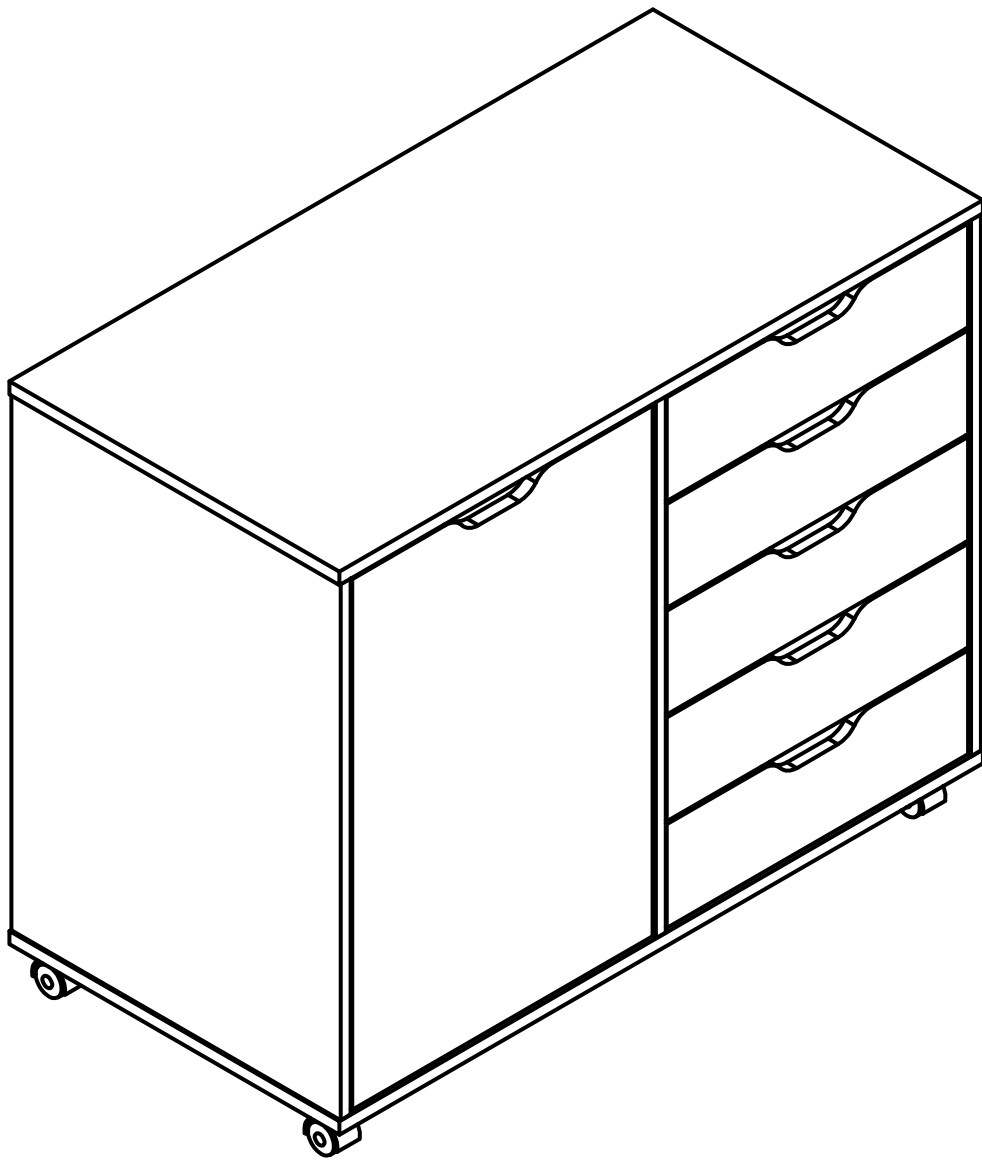

Thank you for choosing this product. We strive to provide you with the best quality products and service in the industry. Should you have any issues, please don't hesitate to contact us.