

Assembly instructions

Modular Sofa

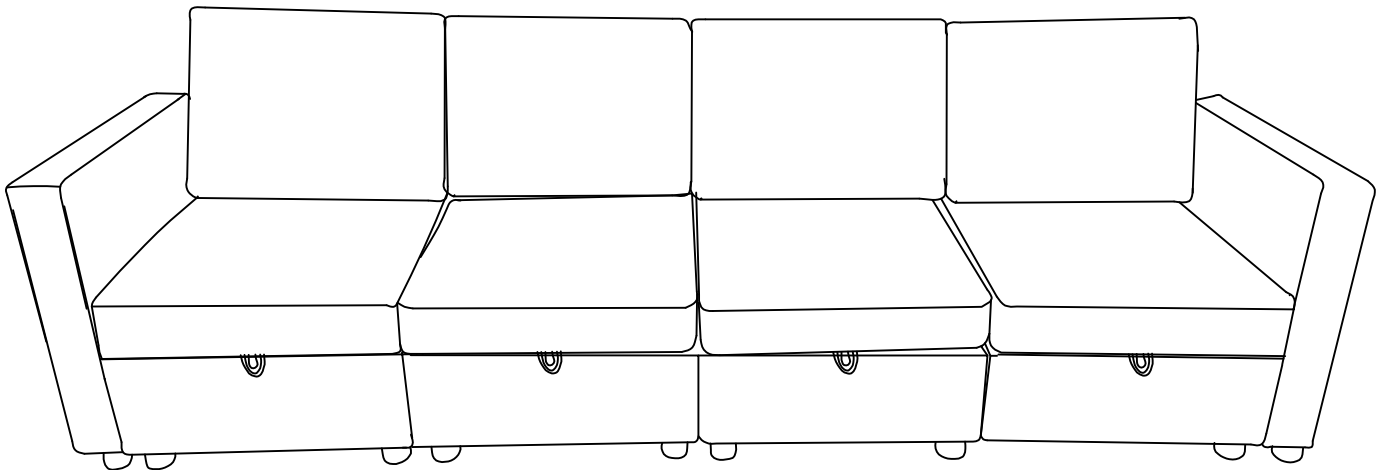

BOX A PARTS LIST

(AL)

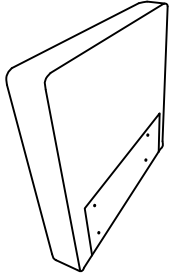

1PC

(AR)

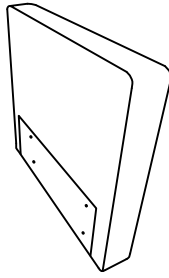

1PC

(C)

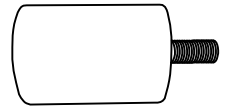

4PCS

(D)

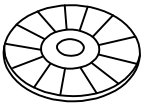

8PCS

(E)



8PCS

(F)

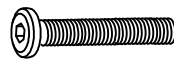

M8*60MM
8PCS

(G)



1PC

BOX B PARTS LIST

(H)

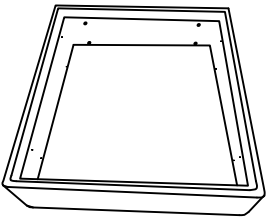

1PC

(I)

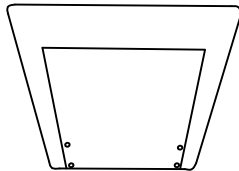

1PC

(C)



4PCS

(D)

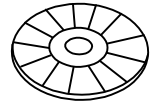

8PCS

(E)



8PCS

(J)



2PCS

(F)



M8*60MM
4PCS

(G)



1PC

(K)



M8*80MM
2PCS

(L)

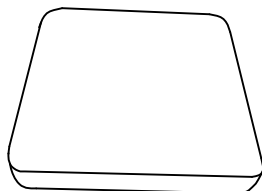

1PC

(M)

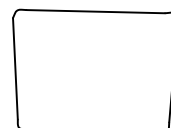

1PC

(N)

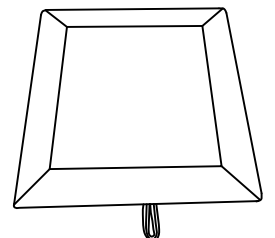

1PC

ASSEMBLY STEPS

STEP1 Unzip the zipper and remove the accessories placed at the bottom of the left armrest AL.



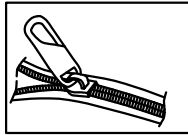
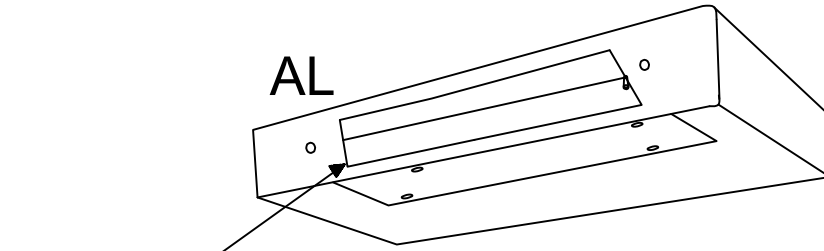

AL		1
----	---	---

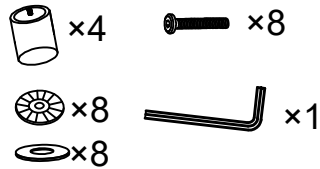

Open the zipper and take out all accessories.



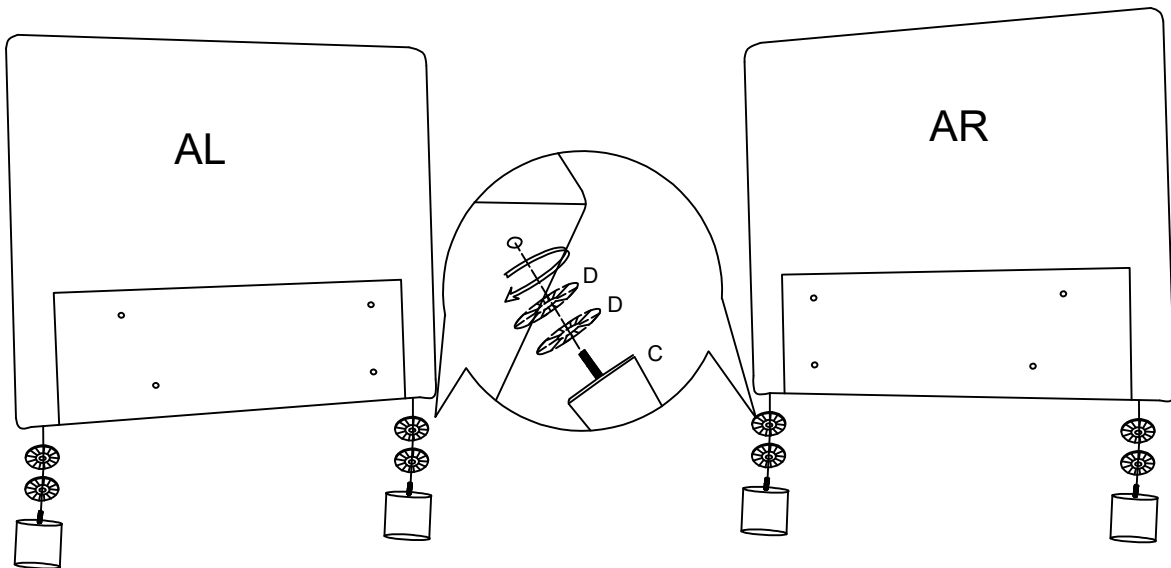

STEP2 Screw sofa leg C with plastic washer D into the armrest (AL/AR).

AL		1
AR		1
C		4
D		8



STEP3 Screw the sofa legs C with plastic washers D into the seat frame H.

H		1
C		4
D		8

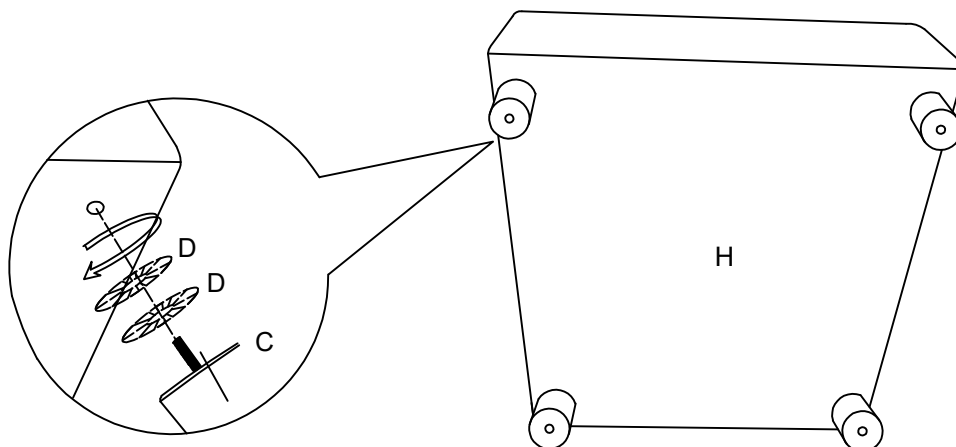

STEP 4 Using an M6 hexagonal wrench, attach the seat frame H to the back plate I with screws F and washers E.

H		1
I		1
F		4
E		4
G		1

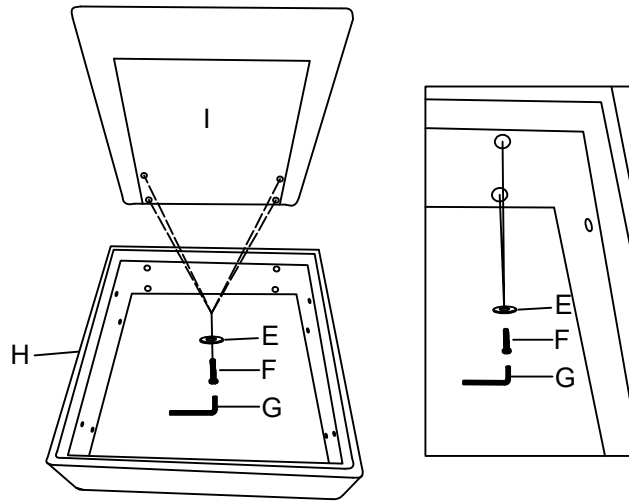

STEP 5 Using an M6 Allen key, connect the armrest (AL/AR) to the center position with screw F and washer E.

A		1
B		1
H		2
I		2
F		8
E		8
G		1

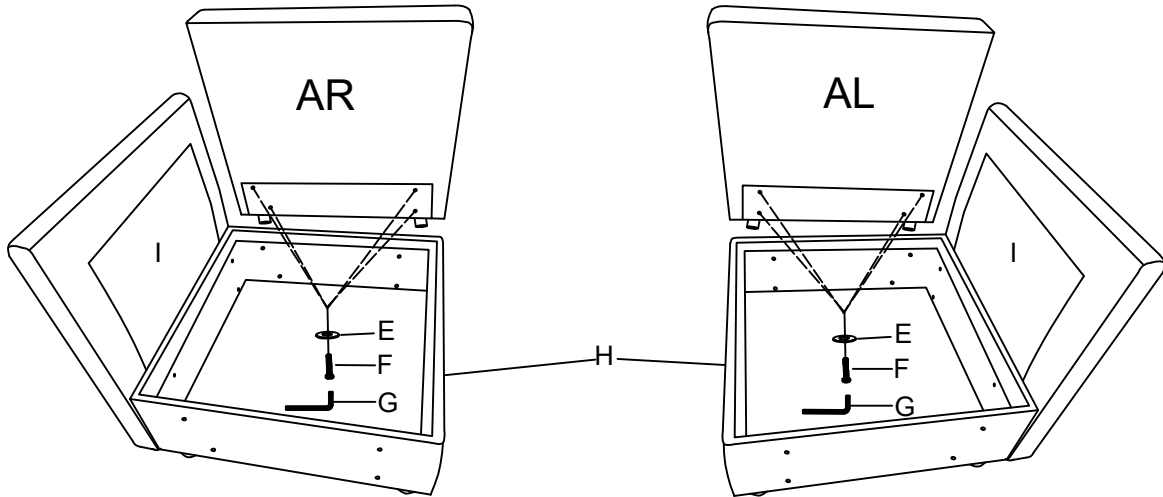

STEP 6 The two sofa seats, screw K and spacer E are locked in place using a wrench against nut J and spacer E.

J		6
K		6
E		12
G		1

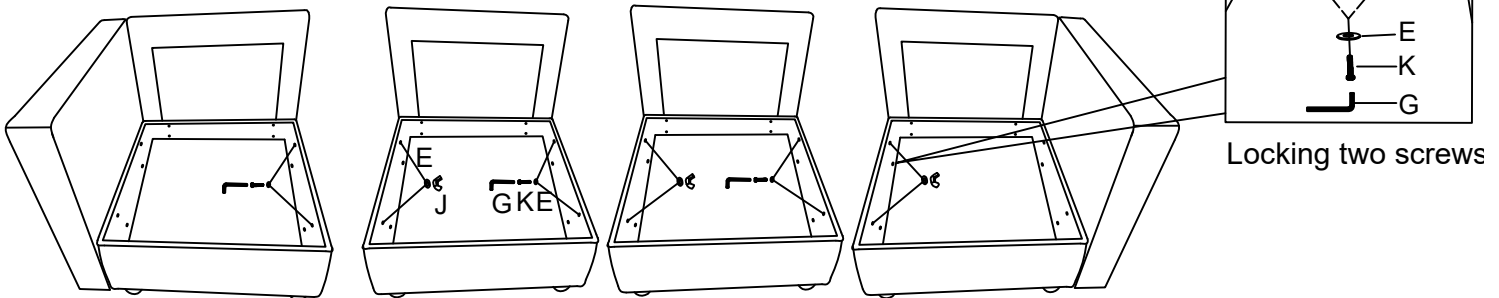

STEP 7

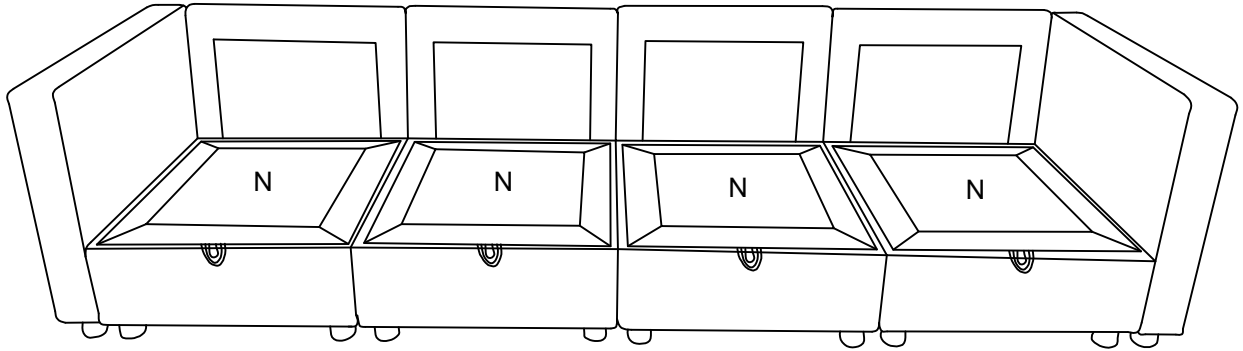
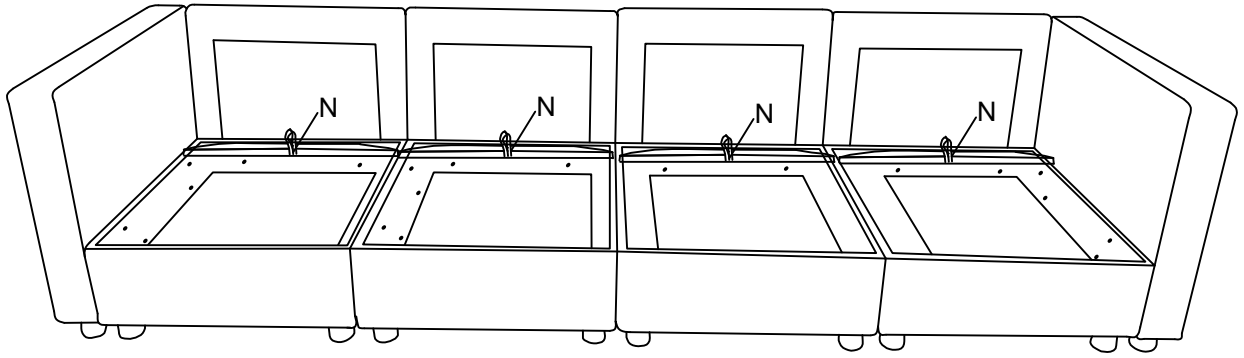

Seat plate N is placed on the seat frame in order.

N		4
---	---	---





STEP 8

If you confirmed the sofa frame fits your space and have a good feeling on seating Part H, then just go ahead to open the vacuum packages for Part M and L.

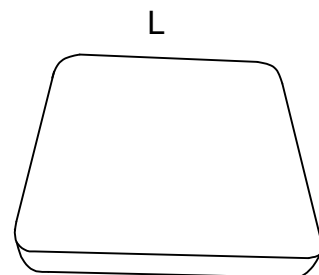
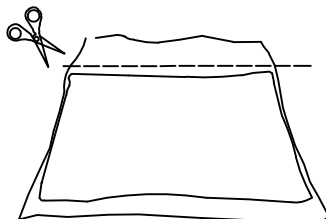
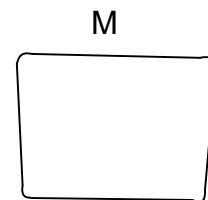
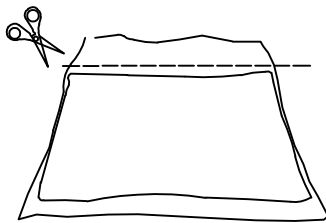
L		4
M		4



STEP 9 Place the cushion on the sofa as shown and if the fabric is wrinkled, wait 72 hours for the cushion to fully spring back.

L		4
M		4

